



Department of Empowerment of Persons with Disabilities (Divyangjan)  
Ministry of Social Justice & Empowerment



सत्यमेव जयते  
GOVERNMENT OF INDIA  
MINISTRY OF SKILL DEVELOPMENT  
& ENTREPRENEURSHIP



# Participant Handbook

Sector  
**Apparel, Made-up's  
and Home Furnishing**

Sub-Sector  
**Apparel**

Occupation  
**Self Employed Tailor**

Reference ID: **AMH/Q1947, Version 2.0**

Reference ID: **PWD/AMH/Q1947, Version 2.0**

**NSQF level: 4**



<https://youtu.be/YdMoYiBDCIM>  
Scan QR code to access e-book

## Self Employed Tailor

for Locomotor Disability

for Speech and Hearing Impairment

All Rights Reserved.

Second Edition

ISBN: 978-93-86620-59-0

Printed in India

### Copyright ©



### Apparel Made-ups & Home Furnishing Sector Skill Council

Flat No. A-312 to A-323, 3rd Floor, Somdatt Chamber-1,

Bhikaji Cama Place, Africa Avenue, New Delhi-110066

E-mail: [jdop@sscammh.com](mailto:jdop@sscammh.com)

Website: [www.sscammh.com](http://www.sscammh.com)

### Disclaimer

The information contained herein has been obtained from sources reliable to AMHSSC. AMHSSC disclaims all warranties to the accuracy, completeness or adequacy of such information. AMHSSC shall have no liability for errors, omissions, or inadequacies, in the information contained herein, or for interpretations thereof. Every effort has been made to trace the owners of the copyright material included in the book. The publishers would be grateful for any omissions brought to their notice for acknowledgements in future editions of the book. No entity in AMHSSC shall be responsible for any loss whatsoever, sustained by any person who relies on this material. The material in this publication is copyrighted by AMHSSC. No parts of this publication may be reproduced, stored or distributed in any form or by any means either on paper or electronic media, unless authorized by the AMHSSC.

#### Note: SCPwD

SCPwD has borrowed the qualification of Self Employed Tailor from Apparel SSC which is approved by NCVET in the 4th meeting of NSQC on 24<sup>th</sup> December 2020 (Link of MOM

<https://ncvet.gov.in/sites/default/files/Minutes%20of%204th%20NSQC%20Meeting.pdf>

pdf And uploaded on NQR WWW.nqr.gov.in The book caters to the job role aligned to the following disabilities as per the NQR codes mentioned below.

For LD- 2020/PWD/SCPWD/04042

For SHI- 2020/PWD/SCPWD/04043





**Shri Narendra Modi**  
Prime Minister of India

“ Skilling is building a better India.  
If we have to move India towards  
development then Skill Development  
should be our mission. ”



## Certificate

### COMPLIANCE TO QUALIFICATION PACK – NATIONAL OCCUPATIONAL STANDARDS

is hereby issued by the  
**Skill Council for Persons with Disability**  
for

**SKILLING CONTENT: PARTICIPANT HANDBOOK**  
Complying to National Occupational Standards of  
Job Role/ Qualification Pack: Self Employed Tailor (Divyangjan) QP. No. PWD/AMH/Q1947  
NSQF LEVEL 4

Date of Issuance: 30 September 2021  
Valid up to\*: 30 September 2024

\*Valid up to the next review date of the Qualification Pack or the  
'Valid up to' date mentioned above (whichever is earlier)

Authorised Signatory  
(Skill Council for Persons with Disability)



## Acknowledgements

We are thankful to Methods Apparel Consultancy India Pvt Ltd and to all organisations and individuals who have helped us prepare this Participant Manual.

We are especially thankful to Shahi Exports Pvt Ltd, Orient Fashions Exports (India) Pvt Ltd, Matrix Clothing Pvt Ltd, Richa Global Exports Pvt Ltd, Modelama Exports Pvt Ltd, Numero Uno Clothing Ltd, FCR Kiran Modes and M/S Khorania Brothers for their kind support in the development of this manual.

## About this book

This Participant Handbook is designed to enable training for the specific Qualification Pack(QP). Each National Occupational (NOS) is covered across Unit/s.

Key Learning Objectives for the specific NOS mark the beginning of the Unit/s for that NOS.

- AMH/N0102: Maintain work area, tools and machines
- AMH/N0104: Comply with industry, regulatory and organizational requirements and Greening of Job roles
- AMH/N1947: Drafting and Cutting the Fabric
- AMH/N1948: Carry out the process of sewing for dress materials and common household items of textiles
- AMH/N1949: Carry out inspections and alterations to adjust corrections for fittings
- AMH/N1950: Maintain health, safety, security in tailoring shop with Gender & PwD Sensitization

Symbols used in the book have been listed below.

## Symbols Used



Key Learning  
Outcomes



Steps



Time



Tips



Notes



Unit  
Objectives



Exercise



## Table of Content

S. No.	Modules and Units	Page No.
8.	<b>Soft Skills And Communication Skills</b>	<b>221</b>
	Unit 8.1 - Introduction to the Soft Skills	223
	Unit 8.2 - Effective Communication	225
	Unit 8.3 - Grooming and Hygiene	228
	Unit 8.4 - Interpersonal Skill Development	230
	Unit 8.5 - Social Interaction	234
	Unit 8.6 - Group Interaction	236
	Unit 8.7 - Time Management	238
	Unit 8.8 - Resume Preparation	240
	Unit 8.9 - Interview Preparation	242
	<b>Annexure - Resources</b>	<b>245</b>







# 1. Introduction and Orientation

Unit 1.1 - Apparel Industry

Unit 1.2 - Role and Responsibilities of a Tailor



## Key Learning Outcomes

**At the end of this module, participants will be able to:**

1. Familiarise with apparel industry.
2. Understand the roles and responsibilities of a Tailor.

## UNIT 1.1: Apparel Industry

### Unit Objectives

At the end of this unit, participants will be able to:

1. Familiarise with apparel industry.
2. Describe the home furnishing and made-ups sub sectors.

### 1.1.1 Introduction to Sewing

Sewing is the craft of fastening or attaching objects using stitches made with a needle and thread. Sewing is the craft of using needle and thread to attach or fasten objects. It is one of the oldest existing crafts in the world.

Sewing was originally a handmade craft for many years. It was the invention of the sewing machine in the 1800s and the growth of technology and computerization in 1900s that increased the mass production of machine made objects. However, sewing by hand is still a globally popular practice. In areas like haute couture fashion, custom dress creation and such, fine hand sewing is an ongoing demand. Fine hand sewing is thus pursued by hobbyists and textile artists equally.

### 1.1.2 Apparel Sector – Industry Overview

The apparel and textile industry is one of the most booming industries. Apart from providing one of the basic necessities of life, it also plays an important role through its contribution to industrial output, employment generation, and the export earnings of the country. With Indian apparel and textile being among the world's largest producers, the country is also the 5th largest exporter of apparel and textile across the globe with US\$ 36.4 billion. (source: Annual T&A industry report 2021 by Wazir Advisors)

The textile industry is one of the oldest business options in India since the ancient age. Different types of textile fibers are produced in India, among which cotton, jute, silk, and wool are the major ones. Both skilled laborers and unskilled officials are needed to run this business smoothly. Thus, the textile and apparel industry serves as the platform offering a huge number of employment opportunities to eligible people in India. A brief on complete supply chain for apparel industry is shown as below.



Fig.1.1.1: The AMH Value Chain (Source: PwC Analysis 2021)

The apparel and textile industry contributes 5 percent to the country's GDP from the domestic sector, whereas 7 percent is contributed from the industrial output in value terms and the export earnings of the country acquire a contribution of 12 percent from the apparel and textile industry.

Exports of AMH products stood at US\$ 21.5 billion in the year 2019-20 and have grown at a CAGR of 3 per cent since 2009-10. Top exported Apparel and Home Textiles commodities include T-shirts, kitchen & toilet linen, bed linen, men's shirt, women's top. India's domestic AMH market is also expanding rapidly, and domestic consumption stood at US\$ 81 billion growing at a CAGR of 10 percent, between 2005-06 to 2018-19.

The Indian textile sub-sector has traditionally been contributing significantly to the economy and manpower as well as to the structural changes in the manufacturing sector. Several factors that would contribute to the growth would include:

- Rising income levels are expected to increase the demand for home textiles and garments from domestic Consumers.
- Free trade agreements provide India a comparative advantage in the export segment as compared to its competitors – China, Bangladesh and Pakistan – as they create opportunities for manufacturers to supply to potential markets in East Asia.
- Low production cost continues to be an advantage for the sector and, consequently, demand from existing foreign markets continues to increase.
- Structural changes in the sector, with a shift from vertically disintegrated to integrated large firms, with automated machines for yarn and fabric production.
- Increased spending on research and development to enter the specialized fabrics and technical textiles sector.
- Favorable policy environment to support domestic and foreign investments and the implementation of schemes to enhance the production capacity and improve technology.

### 1.1.3 Made-ups and Home Furnishings

The made-ups sub-sector is growing at a steadily increasing pace in the country. The wide variety of products that come under this sub-sector are not only include necessities but also functional and luxury products. Made-ups sub-sector is divided into three (3) broad categories:

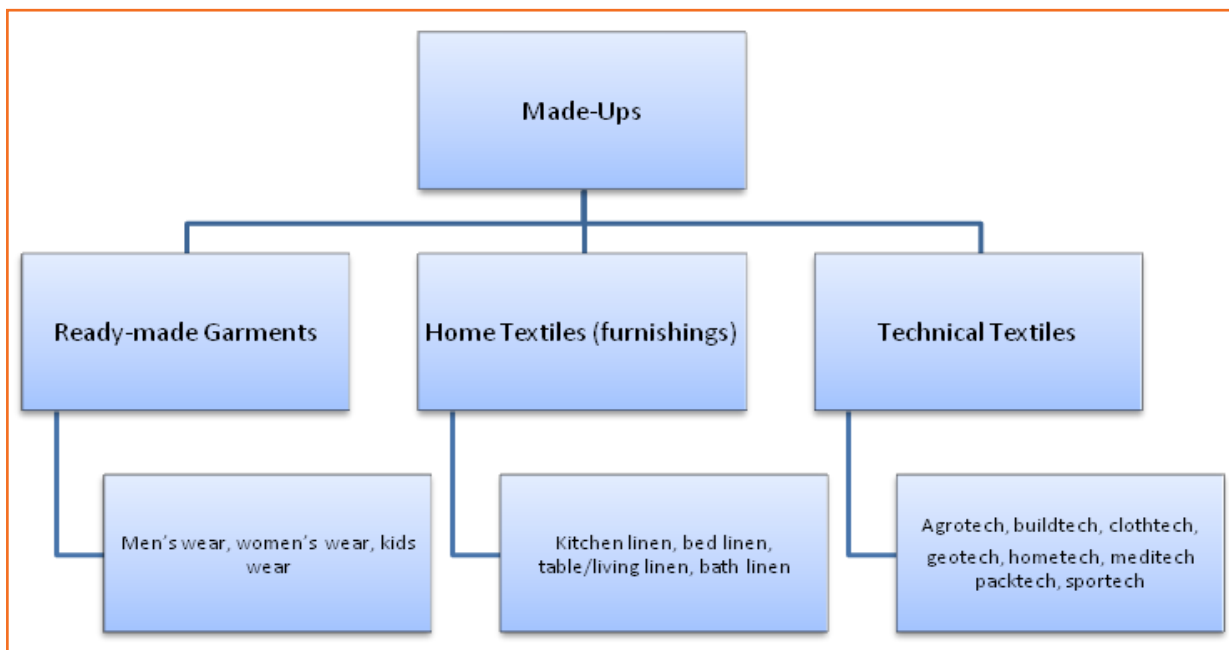

Fig.1.1.2: Made-ups and Home Furnishing Sub-sector



India is among one of the biggest exporters in Apparel and Made-ups industry. In Home Textiles India is second only to China in global exports, whereas in apparels, India is among the top 10. India is fast becoming one of the leading global players in the Home Furnishings/ Textile. Home Furnishings industry offers wide varieties of products like bedspreads, furnishing fabrics, curtains, rugs, cushion covers etc.

The Indian Home Furnishing industry provides a unique blend of modern technology and ethnic techniques to bring out products that are one of the best in the world. The increase in the spending power of the Indian working class is also expected to contribute in the growth of domestic consumption of made-ups and home furnishings industry.



Fig.1.1.3: Home Furnishing

With increased demand and completion from countries like China, the demand of skilled workforce/kaarigars in the Home Furnishings industry is bound to increase in coming years

#### **Size of Indian Textile and Apparel Industry**

In India, the Apparel industry is spread across the country. However, the distribution of the clusters depends on the availability of raw material as well as the manufacturing. Cotton based units can be seen in all parts of the country, while the synthetic and woolen based industries are mainly concentrated in Maharashtra, Gujarat, Punjab, Jammu & Kashmir, Haryana, Madhya Pradesh and Uttar Pradesh. The silk-based industry finds concentration in Andhra Pradesh, Karnataka and Tamil Nadu while, jute clusters are largely located in Bihar and West Bengal.

### **1.1.4 Skill Development Policy**

Indian government runs more than seventy skill development schemes at central, state and district level. The government has launched the Skill India flagship program to empower youth of the country by imparting employable skills to them. Under this initiative, the government has set up Ministry of Skill Development and Entrepreneurship (MSDE) to bring all the skill initiatives of the government under one umbrella and lead skill development ecosystem in the country. The ministry also launched a comprehensive Skill Development Policy in 2015 in which, detailed skill set requirement, courses offered, and roles and responsibilities of different stakeholders were defined. Further, sector wise skill gap analysis was also undertaken to understand sector specific skill requirement.

Pradhan Mantri Kaushal Vikas Yojana (PMKVY) and Deen Dayal Upadhyaya Grameen Kaushalya Yojana (DDU-GKY) are the flagship schemes which offer a variety of courses in the AMH sector. Among other skill development programmes, Integrated Skill Development Scheme (ISDS) was the main program run by the Ministry of Textiles, Government of India, introduced in XIIth Five Year Plan (FY 12-17).

The scheme had a target to train 1.5 million people for the T&A industry. As continuation of the scheme, the ministry has launched Scheme for Capacity Building in Textile Sector (SCBTS) also known as SAMARTH in 2018 with a target to train 1 million people in the sector.

ISDS has helped the industry by supplying skilled workforce, which, in turn, has helped the manufacturers in improving productivity and quality. Overall, it has helped in reducing cost, wastage and improving competitiveness that resulted in better business performances.

## UNIT 1.2: Role and Responsibilities of a Tailor

### Unit Objectives

**At the end of this unit, participants will be able to:**

1. Define a Tailor.
2. Recognise the roles and responsibilities of a Tailor.

### 1.2.1 Self Employed Tailor - Job Description

Self Employed Tailor is a role of a self employed professional tailor who can sew and repair garments, made ups and home-furnishing articles and manage livelihood out of it.

A Tailor, also called a Stitcher is an important job-role associated with Apparel sector and gives livelihood to a number of people who do not have a job. The primary responsibility is to stitch/ sew fabric, fur, or synthetic materials to produce apparels.



Fig 1.2.1: Tailors on the Job

**Attributes:** The tailor should have following attributes:

- Good eyesight
- Eye-hand-leg coordination
- Motor skills
- Clear vision and free from colour vision.

She should have good interpersonal skills, good listener and business acumen.

#### 1.2.1.1 Job Overview

Tailors operate and tend sewing machines in order to perform garment sewing operations. This includes joining, reinforcing and decorating garments or parts of garments. Tailors handle work on a large scale as they are required to operate and tend to industrial machineries. They mount attachments such as needles and pattern blades and adjust machines according to the specifications provided to them.

Tailors also adjust machine controls and regulate stitching speeds for every sewing project that they work on. It is important for tailors to possess in depth knowledge of sewing machinery and the garments industry. They also need to have sound hand-eye coordination and be able to cope with moderate physical effort.



### 1.2.1.2 Tailor's Duties and Responsibilities

- Refer to orders for sewing garments and select appropriate materials.
- Ensure that all materials and auxiliary supplies are available prior to beginning work.
- Start sewing machinery at the beginning of a shift and test it for proper functionality.
- Address any discrepancies or problems faced during the testing period.
- Draw threads through needles and adjust machine functions to meet the requirements of the sewing project.
- Position materials under needles to sew them together or make patterns.
- Replace and re-thread needles for a subsequent project or in case of the existing one needing more thread.
- Sew missing stitches or replacement parts in accordance to repair instructions provided.
- Observe operations to detect any faults or defects in stitching.
- Notify supervisors of any problems or discrepancies during the sewing process.
- Attach button, grips, hooks and fasteners to finished garments.
- Attach elastic or tape to garments as specified in the work order.
- Ensure that the finished product conforms to the design and merchandising instructions provided in the work order.
- Ensure that excess material or threads are cut away from the finished product.
- Trim finished garments using scissors and cutters.
- Perform general and preventative maintenance tasks on sewing machines to ensure their longevity.
- Examine finished garments for compliance and ensure that appropriate tags are sewed on them.
- Count number of garments stitched during a shift and record this information in company provided logs.

### Resources



Scan the QR codes or click on the link to watch the related videos.

Descriptions	QR Codes
Apparel industry in India	 <a href="https://youtu.be/tN5oLGSjepQ">https://youtu.be/tN5oLGSjepQ</a>
Role and Responsibilities of Self Employed Tailor	 <a href="https://youtu.be/YdMoYiBDCIM">https://youtu.be/YdMoYiBDCIM</a>

## Exercise

1. When was sewing machine invented?
  - a) 20th century
  - b) 19th century
  - c) 18th century
  - d) 17th century
2. Increasing size of Domestic market is not good for Industry.
  - a) TRUE
  - b) FALSE
3. Sewing machine operators also responsible for cleaning and maintaining hazard free environment.
  - a) TRUE
  - b) FALSE
4. A Sewing Machine Operator, is responsible for producing quality product confirming quality standards given by buyer.
  - a) TRUE
  - b) FALSE
5. \_\_\_\_\_ scheme is governed by Ministry of Textiles.
  - a) PMKVY
  - b) ISDS
  - c) NULM
  - d) DDUGKY
6. Cutting Department is a part of:
  - a) Pre Production
  - b) Production
  - c) Post Production
  - d) None of the above
7. Full Name of MSDE is:
  - a) Ministry of short distance education
  - b) Ministry of Skill domain education
  - c) Ministry of Skill development and entrepreneurship
  - d) None of the above





## 2. Drafting and Cutting the Fabric

Unit 2.1 - Tools and Equipment Required for Tailoring

Unit 2.2 - Types of Fabric

Unit 2.3 - Trims and Accessories

Unit 2.4 - Size Chart

Unit 2.5 - Taking Measurements

Unit 2.6 - Drafting and Cutting

Unit 2.7 - Types of Fabric Defects



## Key Learning Outcomes

**At the end of this module, participants will be able to:**

1. Recognize the different types of material and tools used in stitching.
2. Explain the stitching terms.
3. Recognize the different types of fabric.
4. Identify the trims and accessories.
5. Describe the importance and use of trims and accessories.
6. Identify the different size chart comparison tables.
7. Elaborate the different terms used in size charts.
8. Take measurements for different garments.
9. Identify different types of defects and faults in fabric and stitching.

## UNIT 2.1: Tools and Equipment Required for Tailoring

### Unit Objectives

At the end of this unit, participants will be able to:

1. Recognize the different types of material and tools used in stitching.
2. Paraphrase the stitching terms.

### 2.1.1 Basic List of Material and Tools Required for Stitching

There are various processes a tailor follows while stitching a garment. There are various tools which aid each of these processes. Types of tools are as:

1. Measuring tools
2. Cutting tools
3. Marking or drafting tools
4. Hand tools

**Scissors:** Scissor are utilized for cutting the fabric and has a handle which is aligned with the blade which helps you do the cutting steadily by keeping the scissors even.



Fig.2.1.1: Scissors



Fig.2.1.2: Rotary cutter

**Rotary cutter:** The rotary cutter is something which has a blade to cut easily and smoothly through fabric. It's very efficient to be used to all different kinds of projects, however it is especially good for quilting. All you require is a rubber cutting mat and a rotary ruler so that when you are using a rotary- cutter the surface of the Fig can be prevented from getting cut. Also, keeping a mat helps in cutting a fabric in straight.

**Thread:** Various sort of threads are available, they are available in rainbow colors, including clear ones. For most of the sewing machines all you need is a need a spool of thread. The cone shaped threads are also used however they are for different kind of machine called a serger.



Fig.2.1.3: Threads



Fig.2.1.4: Measuring tape

**Measuring tape:** Measuring tape used for sewing to make it softer than that used for construction projects so that it can be used to fit clothing to the body.

**Needles:** A sewing machine requires diverse needles than which are used for hand-sewing. Machine needles have a bigger, blunter tip where they fit into the machine. Various types of needles are used on various kinds of projects.

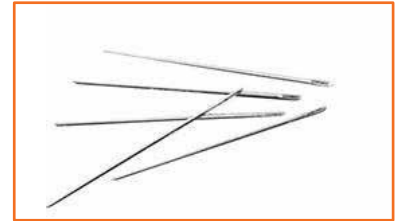

Fig.2.1.5: Needles



Fig.2.1.6: Fabric

**Fabric:** As different projects have different types of needle or thread requirements similarly as per the requirement different types of fabrics are also needed with different project for sewing.

**Pins:** Pins are used to hold fabric together where it's supposed to be sewn and to be adjusted as per the required fitting during alterations.

**Pincushion:** Pincushions are very useful in keeping the pins in order and in place, it is usually in apple's pumpkin's or tomato's shape.



Fig.2.1.7: Pins and Pincushion



Fig.2.1.8: Iron and Ironing Board

**Iron and Ironing Board:** An iron is used to press fabric, seams open and make darts. Your everyday iron is fine.

**Seam ripper:** The name says it all: It's used to rip seams. Especially comes in handy when you're a beginning sewer.



Fig.2.1.9: Seam ripper



Fig.2.1.10: Pinking Shears

**Pinking Shears:** cuts a zigzag edge and is used for finishing hem edges, seams, etc. It should not be used for cutting out a garment b'coz it will not give an accurate cut line of the fabric.



Fig.2.1.11: Cutting Fig

**Cutting Fig:** A flat board placed on a fig where the fabric is laid out and cut. The fabric can be pinned securely to the cutting board to prevent it from slipping.

**Sewing Gauge:** a 6 inch gauge with a movable indicator convenient for measuring short lengths.



Fig.2.1.12: Sewing Gauge



Fig.2.1.13: Hem Gauge

**Hem Gauge:** a measuring device marked with various depths and hemline folds. It is practical when hemming straight on grain edges.

**Yardstick/Meterstick:** is use to measure fabric and to check grain line. It can be used in marking a long straight lines and in measuring hem lengths.



Fig.2.1.14: Yardstick/Meterstick



Fig.2.1.15: Hip Curve

**Hip Curve:** The Hip Curve is used in connecting or shaping slightly curve points. It has a measure of inches at the front and centimeters at the back part.

**L-square:** It is useful in constructing perpendicular lines with divisional parts located in longer and shorter arms.



Fig.2.1.16: L-square



Fig.2.1.17: Tailor's Chalk

**Tailor's Chalk:** A thin piece of hard chalk used in tailoring for making temporary alteration marks on clothing.



**Novelty Yarns:** Novelty yarns include a wide variety of yarns made with unusual features, structure or fiber composition such as slubs, inclusions, metallic or synthetic fibers, laddering and varying thickness introduced during production.



Fig.2.1.18: Novelty Yarns



Fig.2.1.19: Masking Tape

**Masking tape:** Also known as sticky tape, is a type of pressure-sensitive tape made of a thin and easy-to-tear paper, and an easily released pressure-sensitive adhesive. It is available in a variety of widths. It is used mainly in painting, to mask off areas that should not be painted.

**French Curve:** A French curve is a template usually made from metal, wood or plastic composed of many different curves. It is used in manual drafting to draw smooth curves of varying radii. The shapes are segments of the Euler spiral or clothoid curve.



Fig.2.1.20: French Curve



Fig.2.1.21: Hand Needle

**Hand Needle:** Hand sewing needles are available in varying sizes with varying points. They guide the thread through fabric when you are hand sewing.

**Punch Needle:** A Punch needle is an easy to use tool that opens up a delightful world of dimensional needle art. It quickly and easily produces one-level or exciting three dimensional designs.



Fig.2.1.22: Punch Needle



Fig.2.1.23: Frame, Round

**Frame, round:** Used for creating designs through hand stitch.

**Pattern making paper:** Used for practising cutting and creating patterns.



Fig.2.1.25: Tracing paper

**Hand held thread trimmer:** Used for thread trimming.



Fig.2.1.27: Bent neck, metallic Tweezer

**Pencils (HB, 2B, 4B):** The graphite grading scales used to measure the hardness of a pencil's graphite core. The higher the number the harder the writing core and the lighter the mark left on the paper.



Fig.2.1.29: Pick glass



Fig.2.1.24: Pattern making paper

**Tracing paper:** Tracing paper is paper made to have low opacity used for creating designs.



Fig.2.1.26: Hand held thread trimmer

**Bent neck, metallic Tweezer:** Tweezers are small tools used for picking up objects too small to be easily handled with the human hands



Fig.2.1.28: Pencils (HB, 2B, 4B)

**Pick glass:** Handy Reed Pick glass helps in checking the reed pick of the fabric. It also helps in checking the weaving, dyeing & printing defects in the fabric if any is made.

**Needle threader:** A needle threader is a device for helping to put thread through the eye of a needle. Many kinds exist, though a common type combines a short length of fine wire bent into a diamond shape, with one corner held by a piece of tinfoil or plastic.



Fig.2.1.30: Needle threader



Fig.2.1.31: Nonwoven Non-fusible Backing Paper

**Non woven Non-fusible Backing Paper:** It is made of man-made fibers bonded together to form a paper-like sheet. Non wovens (no stretch) are best for medium- to heavyweight fabrics with a slight to very crisp hand. Nonwovens with a crosswise or all-direction stretch can be used for soft to moderate shaping. Fusibles today are fast, secure and easy to use.

**Hand embroidery book:** Used for learning hand embroidery.



Fig.2.1.33: Fabric Glue

**Fabric Glue:** It provide temporary or permanent ways to attach fabric without sewing.



Fig.2.1.32: Hand embroidery book

**Surface ornamentation material (Beads, Sequins):** Decorative material used for decoration of clothes.



Fig.2.1.34: Beads



Fig.2.1.35: Sequins



**Buttons:** are attached to garment by hand stitching or machine stitching



Fig.2.1.36: Buttons



Fig.2.1.37: Hooks

**Hooks:** are attached to garment with the help of needle and thread

**Trims:** Trim or trimming in clothing and home decorating is applied ornament, such as gimp, ribbon, ruffles.



Fig.2.1.38: Trims



Fig.2.1.39: Lace

**Lace:** A fine open fabric of cotton or silk, made by looping, twisting, or knitting thread in patterns and used especially for trimming garments.

**Zipper:** Attached in lower garments.



Fig.2.1.40: Zipper



Fig.2.1.41: Pant Hooks

**Pant hooks:** Attached in lower garments.

**Sewing Mannequin:** it is a type of a doll used by tailors or tailors to display or fit clothing.



Fig.2.1.43: Greyscale

**Greyscale:** It is used for matching colors in the sewed garment against the specifications.



Fig.2.1.42: Sewing Mannequin

## 2.1.2 Understanding Tailoring Terms

- **Lining:** An extra cloth attached under the main garment is known as lining. Used mainly under transparent materials, lining gives the garment extra strength as well as finishing.
- **Inter lining:** An extra layer put in between the main garment and the lining is known as inter lining.
- **Seam allowance:** The margin kept for stitching the garment is known as seam allowance. This means that after drafting the neck, armhole, waist and chest, about 4cm margin is kept and then another line drawn which is the stitching guide – this is known as the seam allowance.
- **Selvedge:** The finished edge of the cloth which is a self-finished edge at the time of weaving is known as selvedge.
- **Panels:** Strips of cloth joined in a garment for fashion or to increase the width are known as panels.
- **Seam:** Seams are the basis of a garment. It is used to attach two pieces of cloth. After cutting the various parts of the garment from a piece of cloth it is these seams either sewn by hand or with the help of a machine which give those various pieces of cloth the shape of a garment.
- **Dart:** Without spoiling the shape of the garment, and in order to give a perfect fit, a small amount of cloth is folded and stitched with a single strand till the other end. This process is called putting a dart. It is used at various places on the garment like bust dart, waist dart etc. to give fitting or fullness to shape.
- **Pleats:** A fold taken from the inside of a garment and held in place by a stitch is known as a pleat. These are of many types like straight pleats, inverted pleats etc. These are used either as a design element or to provide fullness or fitting.
- **Tucks:** Folding the cloth a little from the right side and stitching in a straight line is known as putting a tuck. This is also used to enhance the beauty of the garment or to provide a better fit. If these stitched lines appear of the thickness of a pin then they are known as pin tucks.

## UNIT 2.2: Types of Fabric

### Unit Objectives

At the end of this unit, participants will be able to:

1. Recognize the different types of fabric.

### 2.2.1 Types of Fabric

Fabric can be classified into two types:

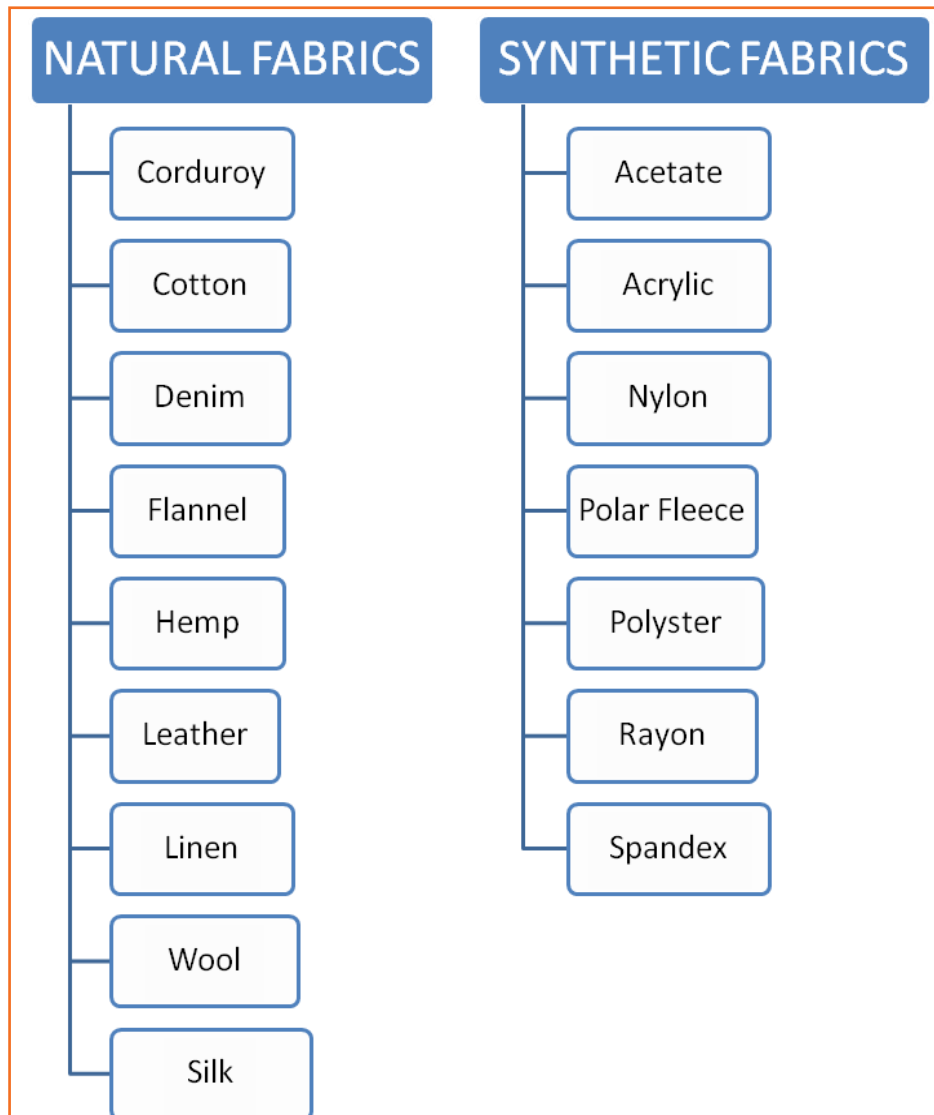

Fig.2.2.1: Types of fabric

## 2.2.2 Fabric Commonly used for Garment Sewing

### Silk

Silk is a natural protein fibre. It is a delicate fabric and is very light weight and due to these features it has a free flowing and smooth drape. It has a slightly shimmery appearance. It is a difficult fabric to work with as it is very slippery. Its elasticity is very moderate to poor. Apparels made of silk have to be Dry cleaned.



Fig.2.2.2: Silk



Fig.2.2.3: Velvet

### Velvet

Velvet is a type of woven tufted fabric. Good quality velvet is made of cotton or polyester. The most expensive velvet is made of silk and sold today as 'Silk Velvet'. Velvet has a smooth, soft and rich touch and often used in evening wear and also extensively used for upholstery. Apparels made of velvet have to be Dry cleaned.

### Chiffon

Chiffon is a sheer fabric with a free flowing drape and crepe like structure. Chiffon is usually made of silk or polyester. It is very light and thin and these features make it a very challenging material to sew. Chiffon is a popular fabric for summer garments because of its light weight.



Fig.2.2.4: Chiffon



Fig.2.2.5: Satin

### Satin

Satin has a sleek and glossy finish. It is made of silk, cotton and wool. It is well draping and is popularly used in dresses, bridal wear and bedding. Thicker wool satin is used for coats. It also makes a great lining fabric. Its slippery nature makes it very difficult to work with.

### Corduroy

Corduroy is normally made from Cotton. It is very similar to Velvet. It is a thick fabric which is very warm and durable. It is normally used in making coats, trousers and winter wear. Corduroys are machine washable.



Fig.2.2.6: Corduroy



### Linen

Linen is very popular in summers because it releases and absorbs perspiration easily. It is very soft, cool and comfortable. Linen wrinkles very easily and has to be ironed on high temperature to remove the creases. It has very little elasticity. Linen is most popularly used in household goods such as bedding, towels and table clothes.



*Fig.2.2.7: Linen*

### Denim

Denim is made from tightly woven cotton. It is a very heavy weight fabric with very little drape or stretch. Denim is very durable and that is why most commonly used in jeans. It is machine washable.



*Fig.2.2.8: Denim*

### Polyester

It is a synthetic fabric. It is strong and durable but does not absorb heat, so it is not a very popular fabric for hot temperatures. It does not wrinkle and dries very easily.



*Fig.2.2.9: Polyester*

### Rayon

Rayon is a manufactured fibre made of cellulose. Like polyester, Rayon is also strong and durable but it wrinkles very easily. It is very soft and comfortable and drapes very well. Hand washing is best for washable rayon garments



*Fig.2.2.10: Rayon*

### Flannel

Flannel is made from wool, cotton or synthetic fibre. It is a soft and light weight fabric. Flannel maybe brushed to create extra softness. It is popularly used for shirts, pants and jackets suitable for colder temperatures



*Fig.2.2.11: Flannel*

### **Organza**

It is made of either silk or polyester. It is a delicate and sheer fabric and very popularly used in evening wear and bridal apparel. The delicate nature of this fabric makes it very difficult to sew.



*Fig.2.2.12: Organza*

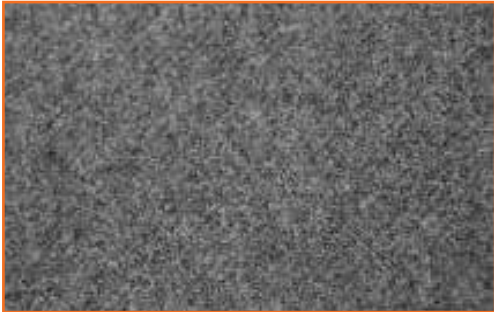

*Fig.2.2.13: Wool*

### **Wool**

Wool is made from variety of animal coats. There are around 200 different types of wool. It absorbs and realises moisture quickly and is a very popular fabric used for cold weather garments. It is hardwearing and resists wear and tear.

### **Leather**

Most commonly made of animal hide. Leather is very durable and absorbs and releases heat quickly so it is very popularly used in winters for jackets and skirts. It is also used in upholstery. Most leather garments require special care in storing and cleaning.



*Fig.2.2.14: Leather*

## UNIT 2.3: Trims and Accessories

### Unit Objectives

At the end of this unit, participants will be able to:

1. Recognise the trims and accessories.
2. Describe the importance and use of trims and accessories.

### 2.3.1 Trims and Accessories

Trims and accessories are considered as an important part of any garment. Apart from enhancing the look of the garment it also increases the usability of the garment.

#### Sewing Thread

The sewing thread holds the garment together. It is a specially designed yarn which passes through a sewing machine easily and makes the sewing process smoother and easier.



Fig.2.3.1: Sewing Thread



Fig.2.3.2: Interlining

#### Interlining

It is fabric which is placed under the main fabric. It is used to enhance the look and retain the shape of the garment. Lining should be chosen carefully as it can influence the colour of the garment if it is different from the colour of the main fabric.

#### Lace

Is a delicate fabric which is made either of thread or yarn. It is used on garments for ornamental purpose.

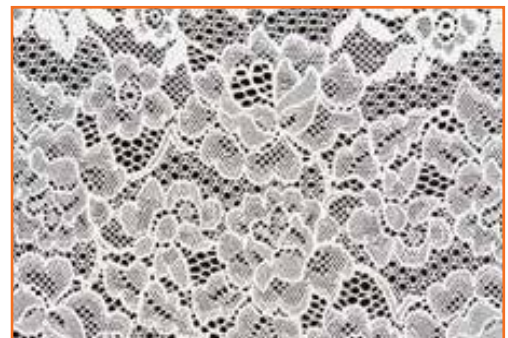

Fig.2.3.3: Lace

### Buttons

Button is a fastener which is used to temporarily secure two pieces of fabric together. It is an accessory which is commonly used in garments. It can be used for both functional and decorative purpose.



Fig.2.3.5: Label

### Zipper

Zipper is also a fastener and is used to temporarily join two ends of a fabric together. It is mainly used in clothing and bags.



Fig.2.3.7: Elastic

### Draw string

It is a long rope with a stopper and is used to tighten a part of a garment. Draw string is also used in bags and pouches.



Fig.2.3.9: Hook and eye



Fig.2.3.4: Buttons

### Label

It is used in every garment. More than one label can be found in every garment and each label provides different required information. Size label, Main label (Name of the company), Price tag label, Composition label, Fabric Care label etc. are some of the labels you can find on garments.



Fig.2.3.6: Zipper

### Elastic

A band which is capable of resuming original shape after stretching or compression. This property of elastic makes its useable in various kinds of garments.



Fig.2.3.8: Draw string

### Hook and eye

It is also a fastener. One part of it works like a hook which is placed into the eye which is like a loop. Both the parts are made of metal and is used to close the waist of skirts and pants.



**Rivets**

It is a metal part with pin which is used for decorative purpose usually in denims and canvas pants.



*Fig.2.3.11: Piping*

**Rib Trims**

It is used in collar and cuff of tshirt and polo shirt.



*Fig.2.3.13: Adjustable waist band*

**Beads**

These are embroidered on to the formal wear as motifs or spread over as individual pieces on the garment.



*Fig.2.3.10: Rivets*

**Piping**

It is used to stabilize seams, outline components and absorb the wear and abrasion to the seam



*Fig.2.3.12: Rib Trims*

**Adjustable waist band**

It is an elastic band with holes and uses a button to tighten or loosen the waist of a garment.



*Fig.2.3.14: Beads*

## Industry Visit

The purpose of visiting a tailor shop/boutique is to get hands on knowledge about various processes involved in the work of a tailor. During the visit you have to interact with Tailors and owner of the shop to understand how work is done in a tailor shop/boutique. Make sure that you keep a notebook handy and note down any important points that come up during your interaction at the tailor shop/boutique. When you go to an tailor shop/boutique, you should:

- Know and recognize the different types of fabric.
- Know about the commonly used fabrics for garment sewing.
- Understand the importance and use of trims and accessories.
- Ask questions to Tailors/shop owners if you have any query.

## UNIT 2.4: Size Chart

### Unit Objectives

At the end of this unit, participants will be able to:

1. Identify the different size chart comparison tables.
2. Follow the different terms used in size charts.

### 2.4.1 Size Charts

Each country formulates and follows its own size charts taking into account the body type and measurements of the general population in the country.

- Womens size chart comparison table
- Mens size chart comparison table
- Kids size chart comparison table
- Terms used in size chart

#### Womens size chart

<b>United States</b>	0	2	4	6	8	10	12	14	16	18	20	22	24
<b>UK</b>	4	6	8	10	12	14	16	18	20	22	24	26	28
<b>Germany</b>	30	32	34	36	38	40	42	44	46	48	50	52	54
<b>France</b>	32	34	36	38	40	42	44	46	48	50	52	54	56
<b>Italy</b>	36	38	40	42	44	46	48	50	52	54	56	58	60
<b>Korea</b>	44	44	55	55	66	66	77	77	88	88			

Fig.2.4.1(a): Womens size chart

<b>Bust</b>	32"	34"	36"	38"	40"
	81 cm	86 cm	91 cm	97 cm	102 cm
<b>Waist</b>	24"	26.5"	29"	31"	33"
	61 cm	67 cm	74 cm	79 cm	84 cm
<b>Hip</b>	35"	37"	39"	41"	43"
	89 cm	94 cm	99 cm	104 cm	109 cm

Fig.2.4.1(b): Womens size chart



**Mens size chart**

Men's shirts											
UK & other EU / Japan	36	37	38	39	40	41	42	43	44	45	46
UK / US / AUS	14	14½	15	15½	15¾	16¼	16½	17	17½	18	18½
Japan <sup>[6]</sup>	S	S	M	M	L	L	LL,XL	LL,XL	LL,XL		
Korea <sup>[6]</sup>	90		95		100		105		110		

Fig.2.4.2(a): Mens size chart

Men's jeans, slacks, pants, trousers: Waist													
EU	64/68	68/72	72/76	76/80	80/84	84/88	88/92	92/96	96/100	100/104	104/108	108/112	112/116
Italy	43	44	45	46	47	48	49	50	51	52	53	54	55
UK / US	27	28	29	30	31	32	33	34	36	38	40	42	44

Men's jeans, slacks, pants, trousers: Length								
EU	34	36	38	40	42	44	46	48
UK / US	25/26	27/28	29/30	31	32	33	34	36

Fig.2.4.2(b): Mens size chart

**Children size chart**

Children's Clothing Sizes			
UK	European	US	Australia
12 m	80 cm	12-18 m	
18 m	80-86 cm	18-24 m	18 m
24 m	86-92 cm	23/24 m	2
2-3	92-98 cm	2T	3
3-4	98-104 cm	4T	4
4-5	104-110 cm	5	5
5-6	110-116 cm	6	6
6-7	116-122 cm	6X-7	7
7-8	122-128 cm	7 to 8	8
8-9	128-134 cm	9 to 10	9
9-10	134-140 cm	10	10
10-11	140-146 cm	11	11
11-12	146-152 cm	14	12

Fig.2.4.3: Children size chart

**Terms used in size charts**

Terms	Meaning
XXS	Double extra small
XS	Extra small
S	Small
M	Medium
L	Large
XL	Extra large
XXL	Double extra large

Fig.2.4.4: Terms used in size charts

**Women's sizing terms**

- **Petite:** Refers not only for short women but also a small framed woman (Women between the height of 4'11- 5'3 ")
- **Tall:** This is for taller women between 5'8"-6' ½" and men 6'1" and taller.
- **Plus size:** This is for women sized 12-24, and XL-4XL (instead of small, medium, and large).

**Men's sizing terms**

- **Big and Tall:** This term is primarily used for men's plus sized clothing — sizes 12 and up, and XXL-4XL

**Fits**

- **Relaxed:** Relaxed fit clothing, also known as oversized or boyfriend-style clothing for women
- **Slim:** Fit clothing is meant for a closer fit to the body and is often used to describe men's dress shirts
- **Rise:** The term rise usually used as "low-rise," "high-rise" or "mid-rise" is used to describe the distance from the waist to the crotch on pants.

## 2.4.2 Using a Measuring Tape and Understanding Fractions

Measuring tape is a common measuring tool used by all tailors. It is a flexible ruler with linear measurement markings on it. It consists of a ribbon of cloth, plastic, fibre glass, or metal strip. Its flexibility allows for a measure of great length permits one to measure around curves or corners.

For taking measurements in garments, generally fibre made measuring tapes are used which have inch markson one side and inch as well centimetre markson the other side.

**Understanding the markings on the measuring tape**

**Inches:** Inches are the long lines that cross either half of, or all of the 1" width of the measuring tape. They usually are preceded or followed by numbers

- 1/2 of an inch is half of 1 inch.
- 1/4 of an inch is every four marks on the measuring tape
- 1/8 of an inch is twice as big as the 1/16 of an inch. It is every other mark
- 1/16 of an inch is usually the smallest

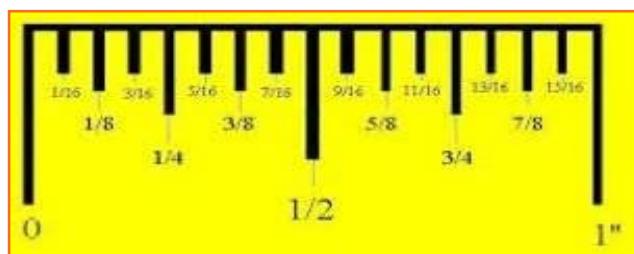

Fig.2.4.5: Measuring tape

Measurement on a tape measure. The distance between every line on the tape measure is 1/16 of an inch 1/32 of an inch is even more smaller which only certain measuring tapes indicate. The distance between every line on the tape measure is 1/32 of an inch

## Understanding Fractions

To divide the measuring tapes into inches, various fractions are used on the measuring tape ( $1/16$ ,  $1/8$ ,  $1/4$ ,  $1/2$  etc.). The figure indicates the various fractions of an inch of measurement

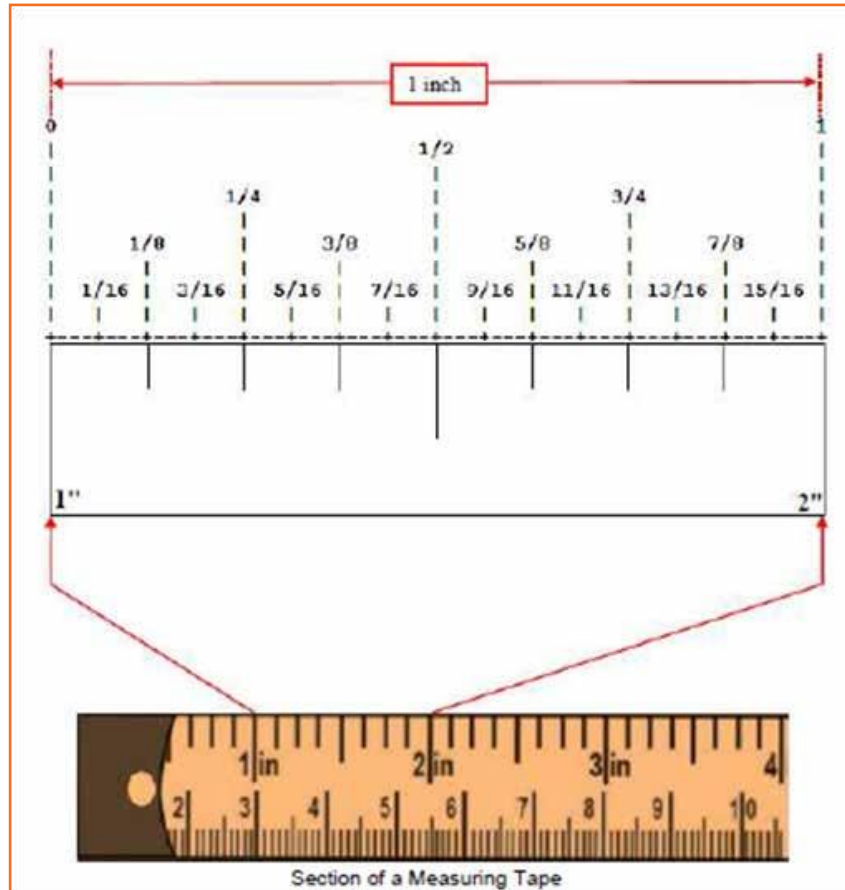

Fig.2.4.6: Fractions in a Measuring tape

## Conversion of inches to centimeters

The below image and conversion table will help us understand how to convert inches into centimeters and centimeters into inches.

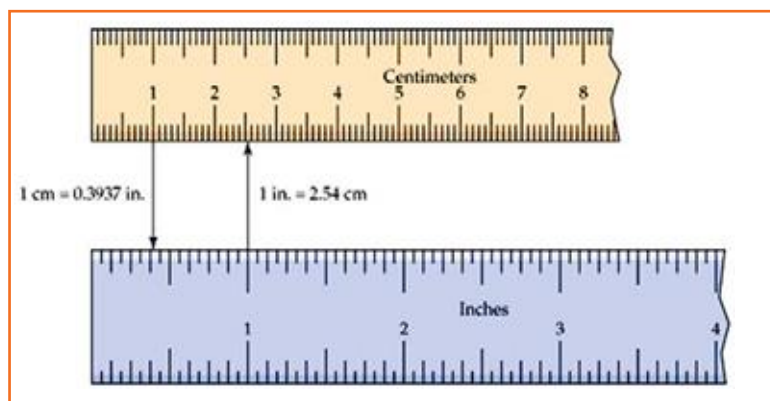

Fig.2.4.7: Different measuring units on a Measuring tape

1 inch = 2.54 cms

2 inch = 2.54 cms x 2

3 inch = 2.54 cms x 3

Inch	Centimeter	Inch	Centimeter	Inch	Centimeter	Inch	Centimeter
1	2.54	26	66.04	51	129.54	76	193.04
2	5.08	27	68.58	52	132.08	77	195.58
3	7.62	28	71.12	53	134.62	78	198.12
4	10.16	29	73.66	54	137.16	79	200.66
5	12.7	30	76.2	55	139.7	80	203.2
6	15.24	31	78.74	56	142.24	81	205.74
7	17.78	32	81.28	57	144.78	82	208.28
8	20.32	33	83.82	58	147.32	83	210.82
9	22.86	34	86.36	59	149.86	84	213.36
10	25.4	35	88.9	60	152.4	85	215.9
11	27.94	36	91.44	61	154.94	86	218.44
12	30.48	37	93.98	62	157.48	87	220.98
13	33.02	38	96.52	63	160.02	88	223.52
14	35.56	39	99.06	64	162.56	89	226.06
15	38.1	40	101.6	65	165.1	90	228.6
16	40.64	41	104.14	66	167.64	100	254
17	43.18	42	106.68	67	170.18	125	317.5
18	45.72	43	109.22	68	172.72	150	381
19	48.26	44	111.76	69	175.26	175	444.5
20	50.8	45	114.3	70	177.8	200	508
21	53.34	46	116.84	71	180.34	250	635
22	55.88	47	119.38	72	182.88	300	762
23	58.42	48	121.92	73	185.42	500	1270
24	60.96	49	124.46	74	187.96	750	1905
25	63.5	50	127	75	190.5	1000	2540

Fig.2.4.8: Units conversion table (Inches to Centimeters)

## Industry Visit

The purpose of visiting a tailor shop/boutique is to get hands on knowledge about various processes involved in the work of a tailor. During the visit you have to interact with Tailors and owner of the shop to understand how work is done in a tailor shop/boutique. Make sure that you keep a notebook handy and note down any important points that come up during your interaction at the tailor shop/boutique. When you go to an tailor shop/boutique, you should:

- Understand the different size chart comparison tables
- Know the different terms used in size charts.
- Understand the difference between US, UK, European and Australian size charts.
- Analyse how a tailor take measurement of man, woman and a child.
- Ask questions to Tailors/shop owners if you have any query.

## UNIT 2.5: Taking Measurements

### Unit Objectives

At the end of this unit, participants will be able to:

1. Take measurements for different garments.

### 2.5.1 Details on How to Take Measurements

**Bust:** Raise the arm to the shoulder level. The measuring tape should cross around the fullest part of the bust. The measuring tape should run directly over the nipples and across the shoulder blades on the back.

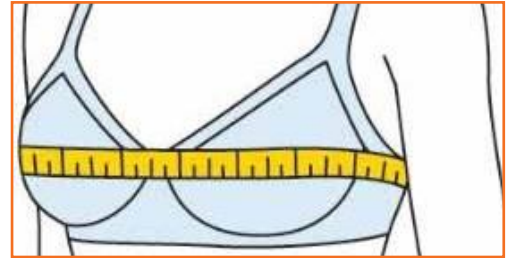

Fig.2.5.1: Bust

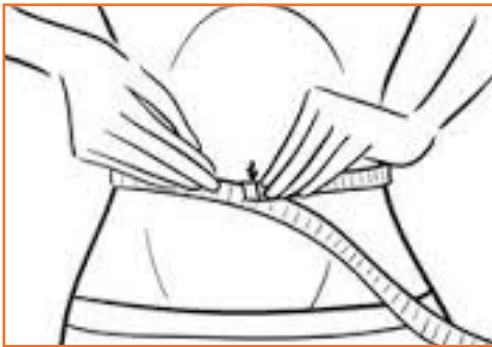

Fig.2.5.2: Waist

**Waist:** The measurement should be taken around the narrowest point of the waistline allowing 2 fingers between the waist and the tape measure.

**Hips:** Standing with the knees together, the measurement should be taken around the fullest part of the hips.



Fig.2.5.3: Hips



Fig.2.5.4: Shoulder to Bust

**Shoulder to Bust:** Run the measuring tape from the tip of the shoulder to the centre of bust.



**Front Shoulder to Waist:** Measure from tip of shoulder over bust to natural waistline.



*Fig.2.5.5: Front Shoulder to Waist*



*Fig.2.5.6: Shoulder to Shoulder*

**Shoulder to Shoulder:** Measure across the back of neck from the socket of one shoulder to the socket of the other shoulder.

**Shoulder to Neck:** Measure from base of neck along top of shoulder to the shoulder socket.



*Fig.2.5.7: Shoulder to Neck*



*Fig.2.5.8: Down Centre Back*

**Down Centre Back:** Measure from nape of neck to natural waist.

**Back Shoulder to Waist:** Measure from tip of shoulder to natural waist line.



*Fig.2.5.9: Back Shoulder to Waist*



*Fig.2.5.10: Across Back*

**Across Back:** Measure from armhole across back to armhole positioning tape measure + - 8cm down from nape of neck.

**Full Back:** Measure from side seam, under armpits to side seam across back, positioning tape measure +/- 4cm down under armpit.

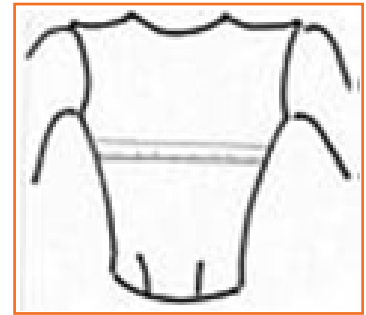

Fig.2.5.11: Full Back



Fig.2.5.12: Sleeve Hole

**Sleeve Hole:** Measure around the shoulder under the armpit.

**Bicep:** Measure around the fullest part of the upper arm.



Fig.2.5.13: Bicep



Fig.2.5.14: Elbow

**Elbow:** Do a fairly loose measurement around the bent elbow.

**Under Arm** - Measure from under the arm. Start at the armpit to the wrist.



Fig.2.5.15: Under Arm



Fig.2.5.16: Over Arm

**Over Arm:** Measure from outer shoulder socket on outside of arm, with a bent arm, to the wrist.

**Side Seam:** Measure from under armpit to natural waistline down.

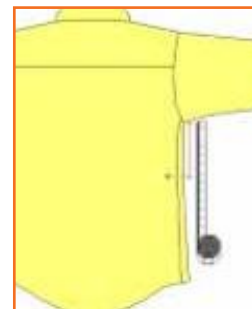

Fig.2.5.17: Side Seam



Fig.2.5.18: Side Seam



**Upper Arm:** Measure from the outer shoulder socket on outside of arm to crook of elbow.



Fig.2.5.19: Upper Arm

## 2.5.2 How to Take Measurement of Basic Garment

**Neck:** The measuring tape should be held around the neck line and just below the Adam's apple



Fig.2.5.20: Neck (courtesy [www.luxurazi.in](http://www.luxurazi.in))



Fig.2.5.21: Full chest (courtesy [www.luxurazi.in](http://www.luxurazi.in))

**Full chest:** The tape should cover the fullest part of the chest. The tape should be held right under the armpits and shoulder blades and across the nipples.

**Shoulder width:** The tape is held from one shoulder point to the other.



Fig.2.5.22: Shoulder width (courtesy [www.luxurazi.in](http://www.luxurazi.in))



Fig.2.5.23: Right sleeve (courtesy [www.luxurazi.in](http://www.luxurazi.in))

**Right sleeve:** Taken from the shoulder tip point down to the desired sleeve length. (The same process is followed for both left and right sleeve measurement)

**Bicep:** Measure around the fullest part of the bicep in line with the armpit.



Fig.2.5.24: Bicep (courtesy www.luxurazi.in)



Fig.2.5.25: Wrist (courtesy www.luxurazi.in)

**Wrist:** Measure around the fullest part of the wrist.

**Waist:** Measure around the fullest part of the waist.



Fig.2.5.26: Waist (courtesy www.luxurazi.in)

### Trouser measurement guide

**Hip:** Measure around the fullest part of the hip or buttock.



Fig.2.5.27: Hip (courtesy www.luxurazi.in)



Fig.2.5.28: Trouser waist (courtesy www.luxurazi.in)

**Trouser waist:** Taken around the smallest part of the waistline. Insert two fingers under the tape measure for ease or allowance.

**Trousers Inseam:** Measure from the lowest part of the crotch area to the floor.

**Trousers Outseam:** Measure from the top of the pants waistband to the desired length of the pants.



Fig.2.5.29(a): Trousers Inseam



Fig.2.5.29(b): Trousers Outseam

(courtesy [www.luxurazi.in](http://www.luxurazi.in))

**Thigh:** Measure around your thigh at its widest point



Fig.2.5.30: Thigh (courtesy [www.luxurazi.in](http://www.luxurazi.in))



Fig.2.5.31: Knee (courtesy [www.luxurazi.in](http://www.luxurazi.in))

**Knee:** Measure around your knee at its widest point.

**Crotch:** Crotch Measure from the front top of the pants waistband to the back top of the pants waistband.



Fig.2.5.32(a): Crotch Back (courtesy [www.luxurazi.in](http://www.luxurazi.in))



Fig.2.5.32(b): Crotch Front (courtesy [www.luxurazi.in](http://www.luxurazi.in))

## Industry Visit

The purpose of visiting a tailor shop/boutique is to get hands on knowledge about various processes involved in the work of a tailor. During the visit you have to interact with Tailors and owner of the shop to understand how work is done in a tailor shop/boutique. Make sure that you keep a notebook handy and note down any important points that come up during your interaction at the tailor shop/boutique. When you go to an tailor shop/boutique, you should:

- Understand the different size chart comparison tables
- Know the different terms used in size charts.
- Understand the difference between US, UK, European and Australian size charts.
- Analyse how a tailor takes measurement of man, woman and a child.
- Ask questions to Tailors/shop owners if you have any query.

## UNIT 2.6: Drafting and Cutting

### Unit Objectives

**At the end of this unit, participants will be able to:**

- Elaborate drafting and cutting.
- Draft the garments on paper then on fabric.
- Cut the garments.

### 2.6.1 Introduction

First we should draft a pattern on paper. Check the measurements and add the seam allowance and then, place the pattern on fabric and cut along the pattern.

Long sleeve shirt is a common wear of men used as upper body wear. Example shown in section 2.6.2 has subsequent specifics.

**Selected fabrics:** poplin, cotton, silk, crepe, polyester, oxford cotton.

**Materials required:** Pattern paper and 2.50 mts cloth width is 36"

**Measurement required:**

- back length = 32"
- n.w length = 17"
- shoulder width = 17"
- chest = 36"
- waist = 32"
- hip or seat = 38"
- sleeve length = 24"
- cuff size = 2 ½" \* 11"
- pocket size = 5" \* 5 ½"

### 2.6.2 Drafting and Cutting of Long Sleeve Shirt

**Drafting details front part:**

- 1-2 = full length + 1".
- 1-3 = chest/4(-) ½", arm depth.
- 1-4 = 1/6th neck measure.
- 4-4a = 1" as per draft.
- 4a-4b = ¾" for button stand.

- $4b-6 = 1\frac{1}{2}$ " for placket.
- $4b-2b$  = draw a line as per draft.
- $6-6a$  = draw a line as per draft.
- $1-7 = \frac{1}{2}$  shoulder width  $+1\frac{1}{2}$ " for seam.
- $7-8$  = draw a line.
- $3-9 = \frac{1}{3}$ rd chest measure.
- $10-4 = \frac{1}{6}$ th neck measure.
- $10-11$  = draw line as per draft.
- $10-12 = 1$ " as per draft.
- $13-7$  = shoulders slope  $1\frac{1}{2}$ ".
- $14-2$  = same as  $9-3$  measure.
- $14-15 = 4\frac{1}{2}$ " as standard measure.
- $14-16 = 5\frac{1}{2}$ " as standard measure.
- $17-8 = 1$ " as per draft.
- 18 is a middle measure of  $13-8$  distance
- $18-19 = \frac{3}{4}$ " as per draft.
- $13, 19, 17, 19$  = draw arm hole shape with arm curve.

- Cut the front part.

#### Back part:

- $20-21 = \text{length} + 1$ "
- $22-24 = \frac{1}{4}$ th chest (-)  $\frac{1}{2}$ " (armhole depth).
- $20-25 = \text{n.w length} + \frac{1}{2}$ ".
- $22-23$  = draw a line.
- $24-24a = \frac{1}{3}$ rd chest (-)  $1\frac{1}{4}$ ".
- $23-23a = 1\frac{1}{4}$ " at  $45^\circ$
- $20-27 = 1$ " as per draft.
- $22-28 = 1$ " as per draft.
- $26-29 = 4\frac{1}{2}$ " as shown in draft.
- $26-30 = 5\frac{1}{2}$ " as shown in draft.

#### Shoulder part :

- $1-2 = \frac{1}{8}$ th chest  $+1\frac{1}{2}$ ".
- $1-3 = \frac{1}{2}$  shoulder width  $+1\frac{1}{2}$ " for seam.
- $3-4$  = draw a line.
- $4-5 = \frac{1}{2}$ " as per draft.

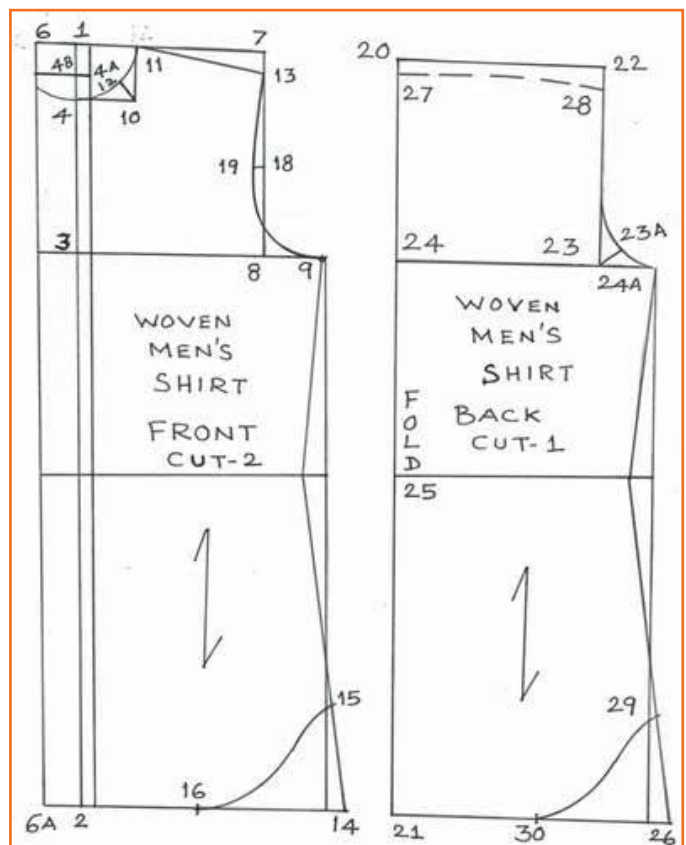

Fig.2.6.1: Drafting of front and back part

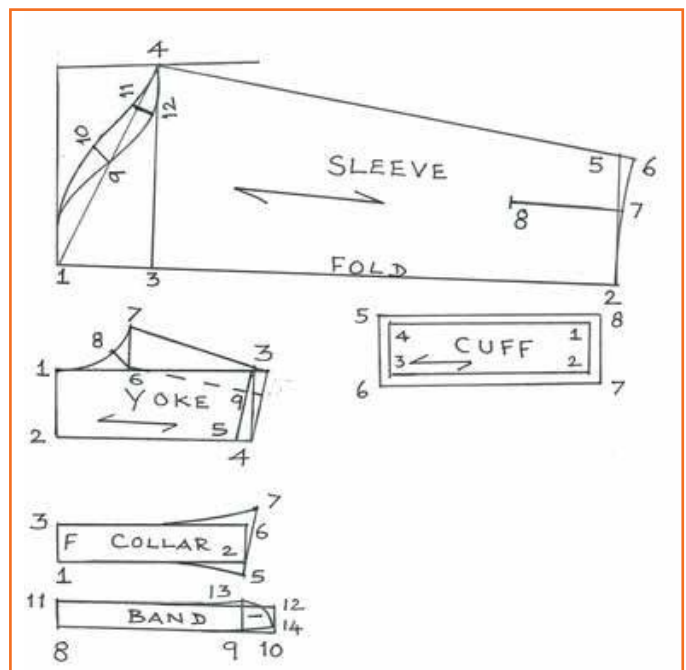

Fig.2.6.2: Drafting of other parts

- 1-6 =  $1/6$ th neck +  $3/4$ ".
- 6-7 = 2" noted as per draft.
- 6-8 = 1" as per draft.
- 3-9 = 2" as per draft.

#### Long sleeve part:

- 1-2 = sleeve length +  $1/2$ " (-) cuff with 2  $1/2$ " .
- 1-3 =  $1/8$ th chest (-)  $1/2$ " .
- 3-4 =  $1/4$ th chest +  $1/2$ " .
- 5-2 =  $1/2$  cuff + 1  $1/2$ " .
- 5-6 =  $1/2$ " as per draft.
- 7 = middle or 5-2 measure.
- 7-8 = .4  $1/2$ " sleeve pocket open.
- 9 =  $1/2$  or 1-4.
- 9-10 = 1", 4, 10, 1 back arm shape is to be drawn
- 11 = middle of 9-4 measure.
- 12-11 =  $3/4$  " as per draft. 4, 12, 9, 1. draw the front arm as per draft.

#### Cuff draft:

- 1-2 = cuff width.
- 1-3 = cuff length to be cut on fusible interlining as stiffer portion.
- Sleeve pocket length 5" .
- Width 1  $1/4$ :" .
- Box 1  $1/4$ " as ready portion and added all around  $1/2$ " for seam margin.

#### Collar part:

- 1-2 =  $1/2$  neck measure
- 2-4 = 2" as standard.
- 2-5 =  $3/8$ " as per draft.
- 4-6 =  $3/8$ " as per draft.
- 7-5 = collar point 3  $1/8$ " .

#### Neck band:

- 8-9 =  $1/2$  neck measure
- 9-10 = 1  $3/8$ " as per draft.
- 11-8 = 1  $3/8$ " as per draft.
- 10-12 = 1  $3/8$ " as per draft.
- 10-14 =  $1/8$ " as per draft.
- To be cut fusible interlining allow to cut self fabric along with seam margin necessarily  $1/2$ " .



## 2.6.3 Drafting and Cutting of Saree Blouse

### Measurements Needed

#### Shoulder Measurement:

- Taken between two shoulder ends or nape of the neck to one shoulder end and doubled. When neckline depth is more than  $\frac{1}{6}$ th of the bust round, shoulder measurement is taken about 3cm to 4cm less on each side.

#### Armhole Depth or Armhole Depth:

- Taken by direct measurement or calculated from the Bust Circumference.
- It is the best to measure the armhole depth directly on the body for accurate measurement. It is measured straight from the shoulder end to about  $\frac{1}{2}$  an inch below the armpit. Armhole depth varies from 13cm – 18cm (or about 5 inch – 7 inch) in the increasing order from the small sizes to the larger ones.
- Armhole depth can be calculated from the bust circumference in many of the ways by different dressmakers for different outfits.
- For a sari blouse, following calculation is found to be the best:

$$\frac{1}{6}\text{th of Bust Circumference}$$

#### Front & Back Neck depths:

- Taken directly on the body or taken from an existing garment.

#### Bust Circumference:

- Taken around the fullest part of the bust.

#### Waist Circumference:

- Taken around the navel point.

#### Bust Point or Pivot Point:

- Taken straight down the shoulder to the bust point.

#### Waist Length:

- Taken from the nape of the neck to the desired length of the blouse.

### Drafting & Cutting Instructions For A Basic Blouse With Waistline Dart

#### Front Part:

1. Square down centre front line and shoulder lines.
  - » Centre Front Line: Waist Length + 1cm for seam allowance at shoulder + 1cm seam allowance at waist
  - » Shoulder Line:  $\frac{1}{2}$  of Shoulder Measurement + 1cm seam allowance. Shoulder can be taken square or sloped. This depends up on the garment to be made. Since a sari blouse is usually of wide neck, no slope is suggested here.
2. Square Armhole Depth down the Centre Front Line. Take  $\frac{1}{4}$ th of the Bust Circumference + 1cm ease + 5cm seam allowance, horizontally. This wide seam allowance is useful for alterations.
3. Drop a straight line from shoulder end on to Armhole Depth. Draw front armhole shape about 1cm inward this dropped line.
4. Square Waist Line at the bottom of the Centre Front Line. Take  $\frac{1}{4}$ th Waist Circumference + 5cm dart allowance + 5cm seam allowance. Give a rounded shape at the sides.

# Basic Pattern for Sari Blouse (With Waist Line Darts)

## Front Bodice

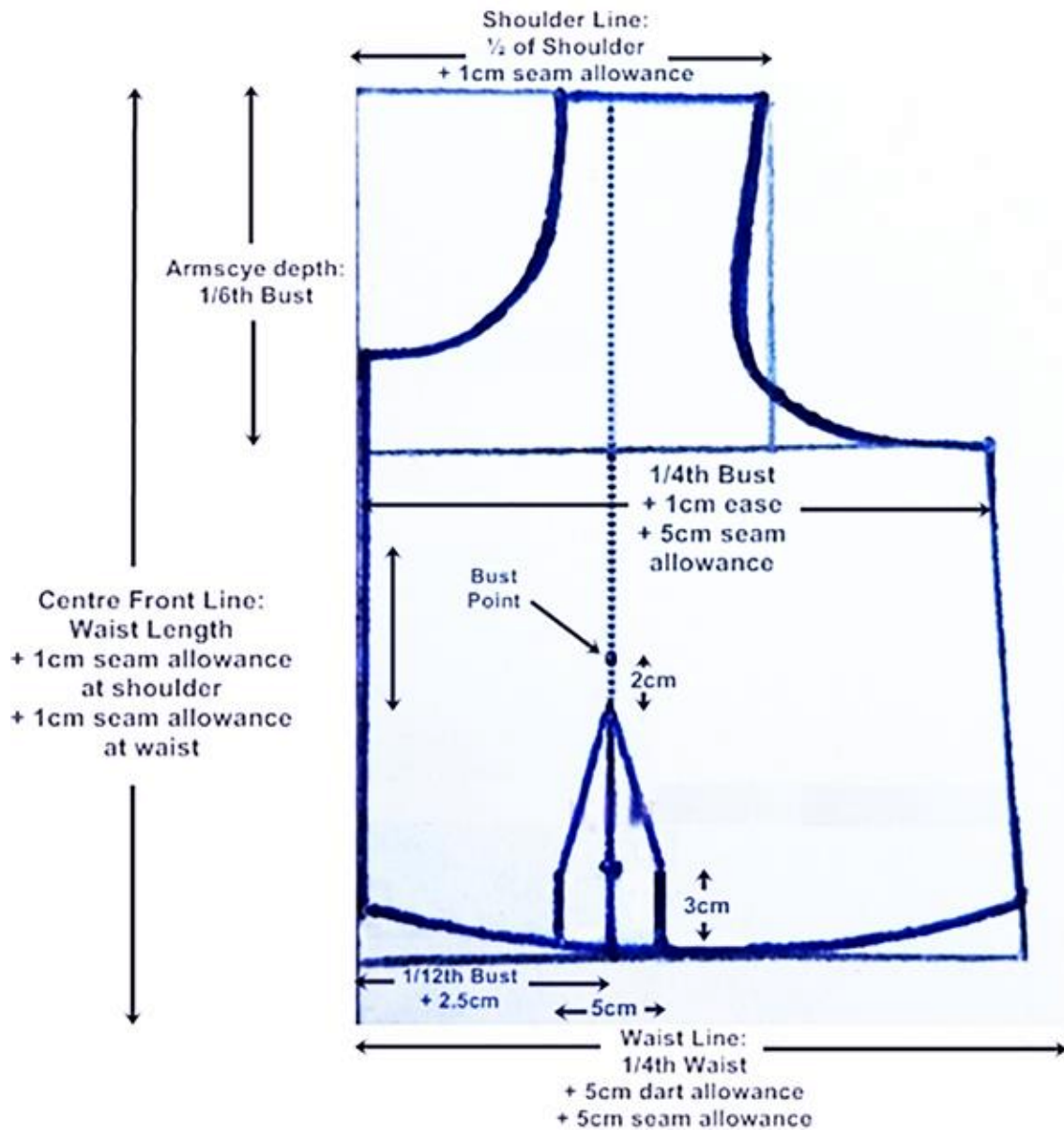

Fig.2.6.3: Front bodice of saree blouse

- Dart:** Take  $\frac{1}{12}$ th of the Bust Circumference + 2.5cm at waist from the centre front. Draw an upright line. Measure a point at about 3cm from the waist. (Note: This will be the starting point of the waist, exactly under the bust part.)

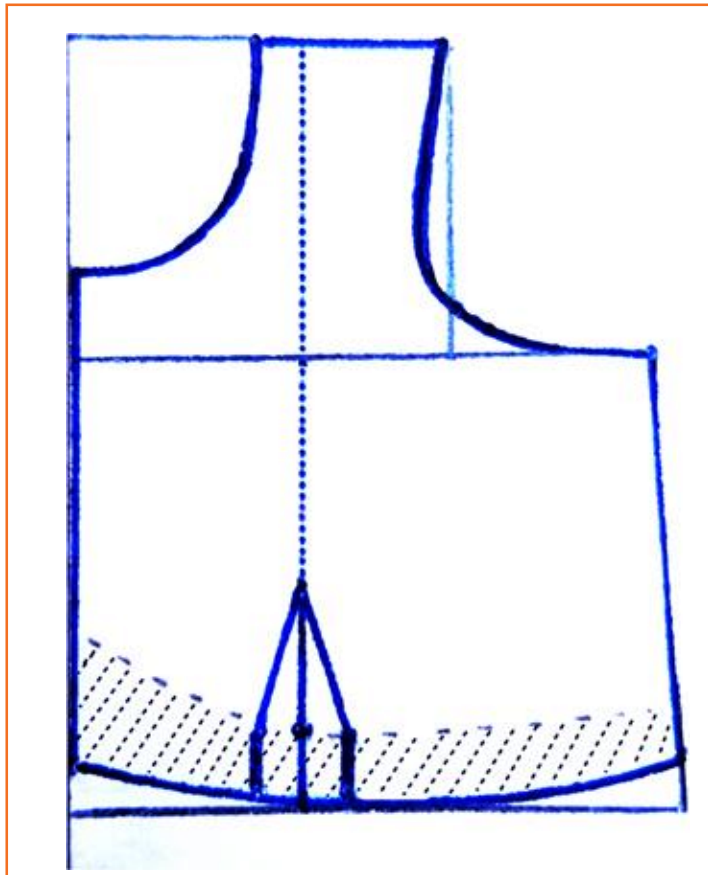

Fig.2.6.4: Waist band of saree blouse

- » Mark a Dart of about 5cm here taking 2.5cm on each side. Measure and mark Bust Point on the same line from the shoulder. Dart point will be about 2cm below the bust point. Draw a dart as shown.
6. Join the end points of Armscye Depth line and waist line.
  7. Draw desired front neckline.
  8. Cut along the highlighted outline excluding the darts as shown.

**Back Part:**

1. Square down centre back line and shoulder lines.
  - » Centre Back Line: Waist Length + 1 cm for seam allowance at shoulder + 1cm seam allowance at waist
  - » Shoulder Line:  $\frac{1}{2}$  of Shoulder Measurement + 1cm seam allowance
2. Square Armscye Depth down the Centre Back Line. Take  $\frac{1}{4}$ th of the Bust Circumference + 1cm ease + 5cm seam allowance, horizontally. This wide seam allowance is useful for alterations.
3. Drop a straight line from shoulder end on to Armscye Depth. Draw back armhole shape on this dropped line.
4. Square Waist Line at the bottom of the Centre Back Line. Take  $\frac{1}{4}$ th Waist Circumference + 2cm dart allowance + 5cm seam allowance. You may need to shape the waistline a little to match it to the front.
5. Dart: Mark a dart on the waist line at  $\frac{1}{12}$ th of Bust Circumference + 1cm. This dart is about 7cm in length with 1cm width on each side.
6. Join the end points of Armscye Depth line and waist line.

## Basic Pattern For Sari Blouse (With Waist Line Darts) Back Bodice

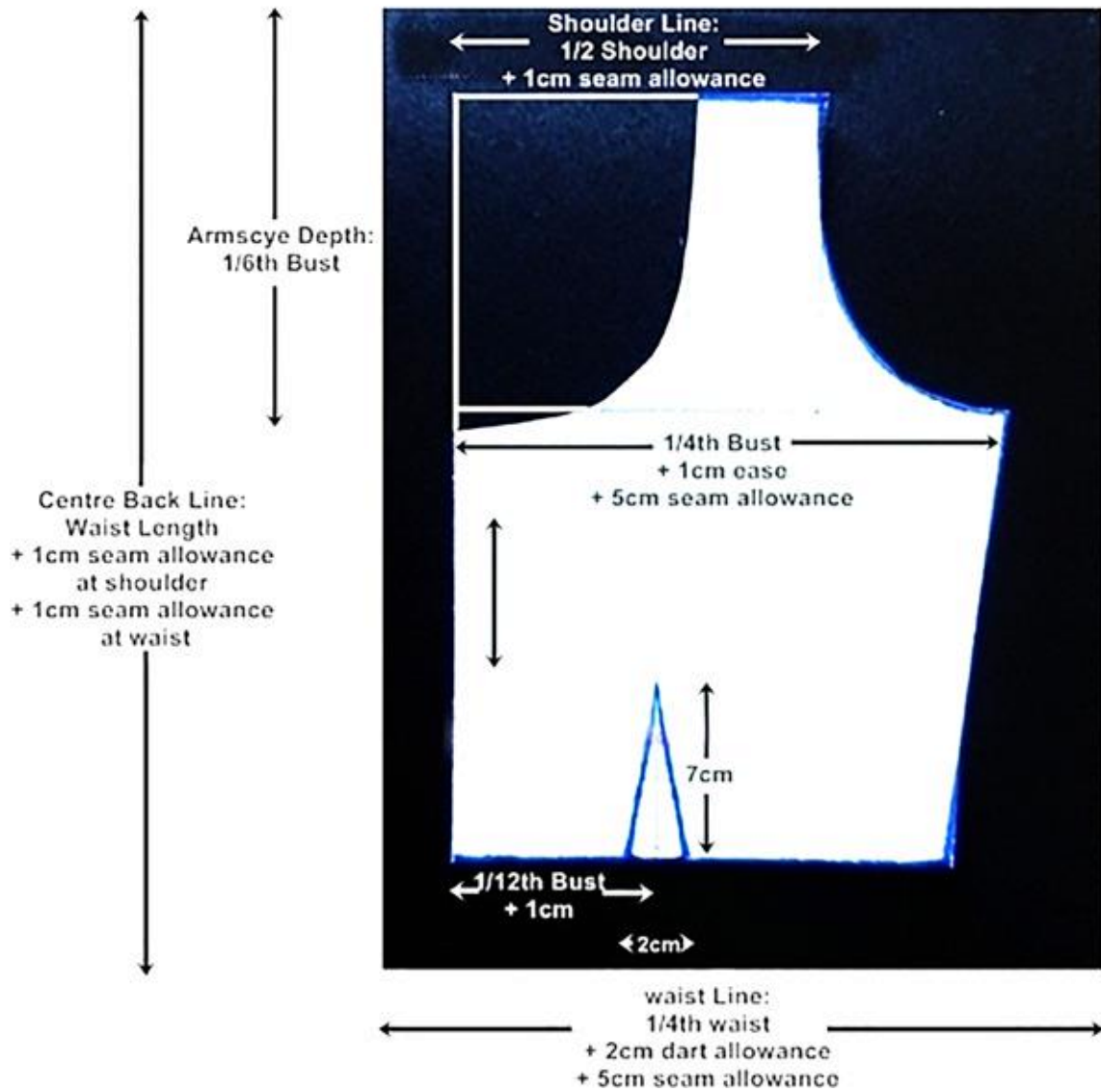

Fig.2.6.5: Back bodice of saree blouse

- Draw desired back neckline. This is usually kept deeper than that in the front.
- Cut along the highlighted outline as shown.

### Fastening:

Fastening can be given in the centre front or in the centre back. Add 1cm seam allowance for the attachment of hook and eye fastening strips.

### Significance of Having A Basic Bodice Pattern

- This is the basic most pattern for sari blouse exclusive of waist bands and extra darts. Assembling is simple for the apprentices.
- Any style variation in the neckline can be tried on this pattern. For high necks, a shoulder slope is given.
- This pattern helps as a base for all the types of princess lines. For details on princess lines, click here. Just eliminate the darts without a need to press the design as given here.
- Easy to increase length.
- Back or front clasp styles are easily modified. This pattern is without the seam allowance for fastening. 1cm seam allowance is to be added at the centre (front or back) to give an opening.

## 2.6.4 Drafting and Cutting of Kurta/Kameez

Kurta and/or Kameez are traditional costumes of India. It is used along with Salwar, Churidar or denim pants. The Collar or the neckline can be shaped according to style. This garment is cut into three pieces, the front, back and sleeve. Darts are used to give fit or shape to the garment. The creation of Kameez may look long but it is very easy, just follow the instructions and you will end up with your own Kameez top.

The construction of Kameez may look long but it is very easy, just follow the instructions and you will end up with your own Kameez top.

### Measurement

- Square Neck: 14 Inches
- Across Shoulder: 14 inches
- Chest: 36 inches
- Waist: 28 inches
- Hip: 38 inches
- Length of Top: 25 inches

### Material Required:

- 1¼ Mtrs of fabric

### Construction - Front

(0-1) = Kameez length (desired length)

(0-2) = Armhole depth =  $\frac{1}{4}$  chest – 1" (for Medium figure) or 2" (for heavier figure)

(2-3) = Chest line =  $\frac{1}{4}$  chest + 1" (for Tight fit) or 2" (for loose fit)

(5-6) = Shoulder drop = 1cm

(0-5) & (2-6') =  $\frac{1}{2}$  shoulder

(0-7) = Neck width

(0-9) = Front neck depth

X is mid point of 6-6'. (x-x') = 1cm

Shape (6-x'-3) front armhole curve.

Measure 6-x'-3 it should be more than  $\frac{1}{2}$  armhole by 3 to 4cms.

(0-10) = waist length

(10-11)=  $\frac{1}{4}$  waist + 1" or 2" (same as chest line)

(0-12) = Hip length

(12-13)= Hip line =  $\frac{1}{4}$  hip+2"

(1-4) = same as hip line

(4-4') = 1" up for shaping. Join (1-4') hem line

(4'-13) = Slit opening (Slit should not cross the Hip line)

**Cutting line:**

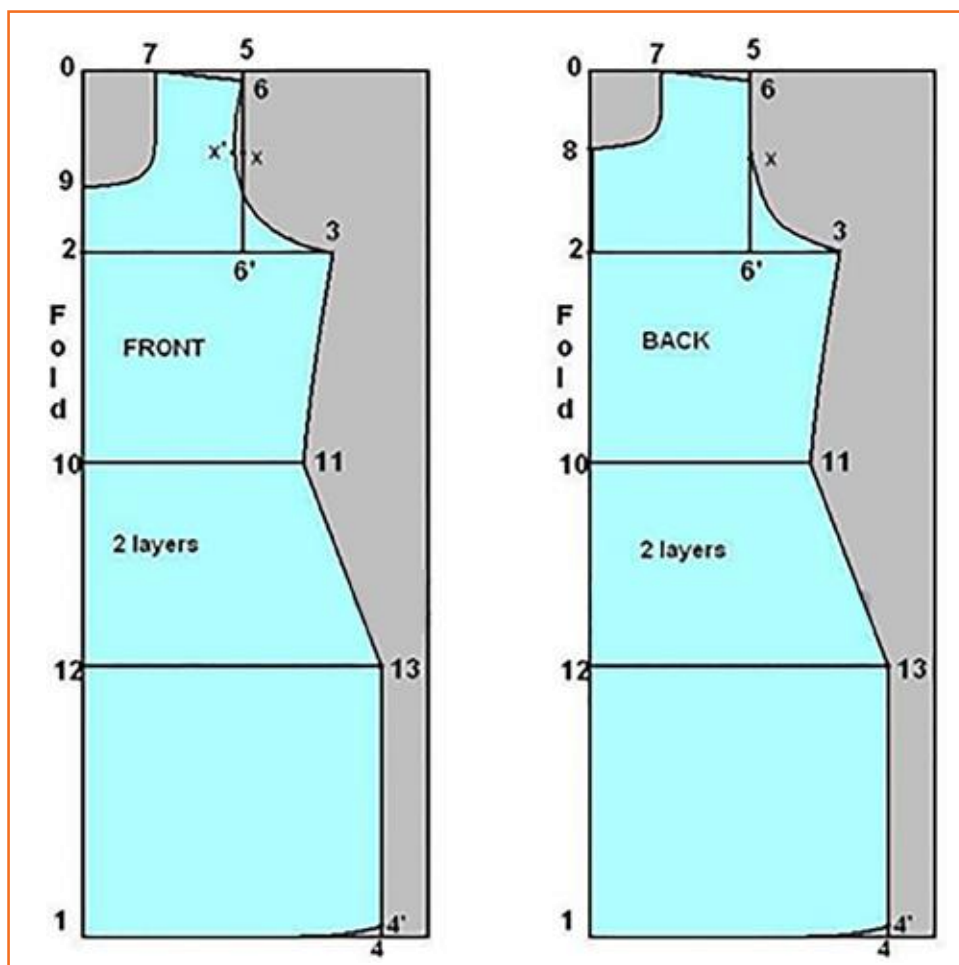

Fig.2.6.6: Kurta - Front and Back

9-7-6-x'-3-11-13-4'-1 (9-1) on fold

**Construction - Back**

(0-1) = Kameez length

(0-2) = Armhole depth =  $\frac{1}{4}$  chest - 1" (for Medium figure) or 2" (for heavier figure)

(2-3) = Chest line =  $\frac{1}{4}$  chest + 1" (for Tight fit) or 2" (for loose fit)



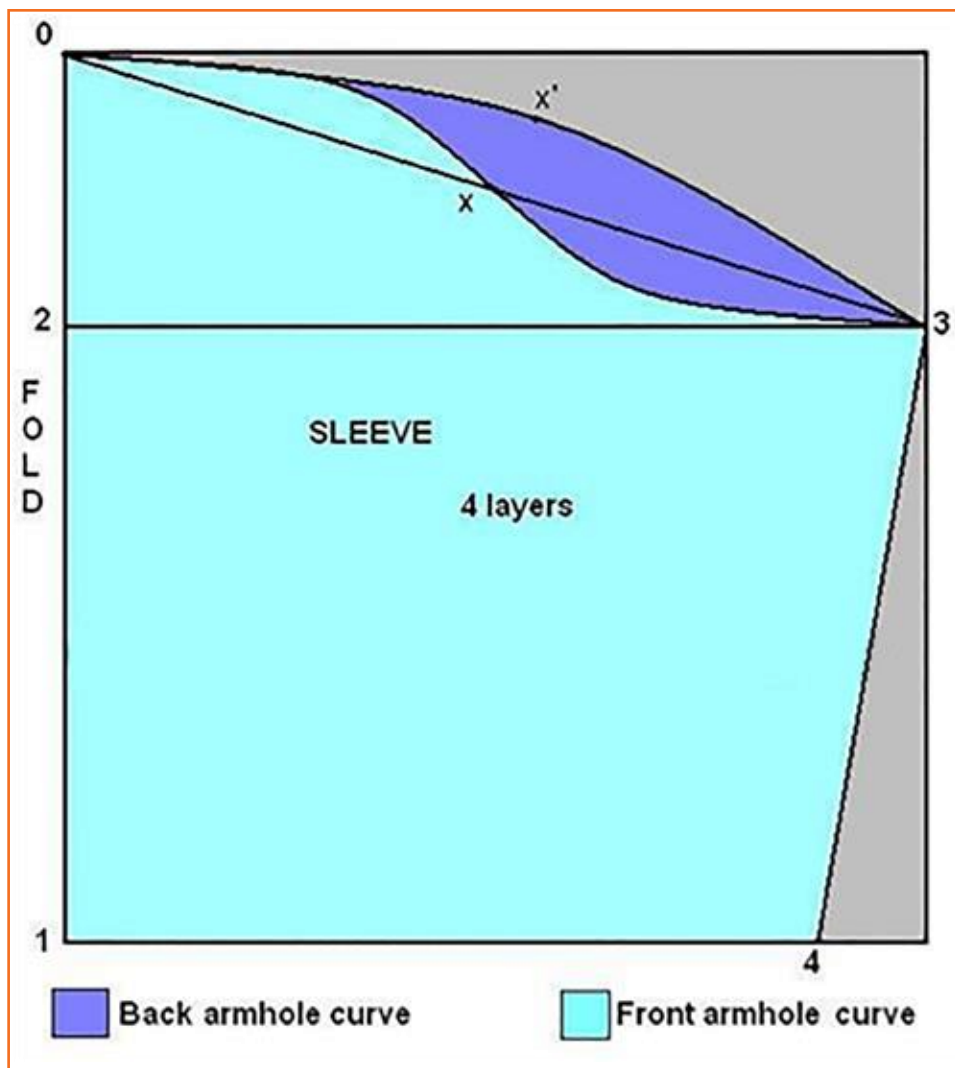

Fig.2.6.7: Kurta - Sleeve

(5-6) = Shoulder drop = 1cm

(0-5) & (2-6') =  $\frac{1}{2}$  shoulder

(0-7) = Neck width

(0-8) = Back neck depth

(8-8') = Back slit opening =  $\frac{1}{6}$  chest + 1"

X is mid point of 6-6'.

Shape (6-x-3) front armhole curve.

Measure 6-x-3 it should be more than  $\frac{1}{2}$  armhole by 3 to 4cms.

(0-10) = waist length

(10-11) =  $\frac{1}{4}$  waist + 1" or 2" (same as chest line)

(0-12) = Hip length

(12-13) = Hip line =  $\frac{1}{4}$  hip+2"

(1-4) = same as hip line

(4-4') = 1" up for shaping. Join (1-4') hem line

(4'-13) = Slit opening (Slit should not cross the Hip line)

Cutting line:

8-7-6-x-3-11-13-4'-1 (8-1) on fold

Cut 8-8' on fold for back neck slit opening (Neck slit opening need only at the circumference of head is lesser than neck circumference)

**Construction: Sleeve**

(0-1) = Sleeve length

(0-2) =  $1/8$  chest –  $1\frac{1}{2}$ "

(2-3) =  $1/4$  chest –  $3/4$ "

(1-4) =  $1/2$  round arm

Join (3-4) under arm seam

Join (0-3)

X is the mid point of (0-3)

Take (x-x') = 2 to 2.5cms up

Shape 0-x-3 front armhole curve

Shape 0-x'-3 front armhole curve

**Cutting line:**

1-4-3-x'-0 then cut through the first 2 layers 0-x-3

Seam Allowance:

$1/4$ " on neck line, armhole and back neck slit open

1" on side seams

$1\frac{1}{2}$ " on hemlines

## 2.6.5 Drafting and Cutting of Pant

To draft your pants, you'll need to do a little math. First, take your child's hip measurement and divide it by 2. Then add 9 inches. Call this number A. Next, add the rise plus the inseam. Call this number B. Draw a rectangle that is A wide by B tall.

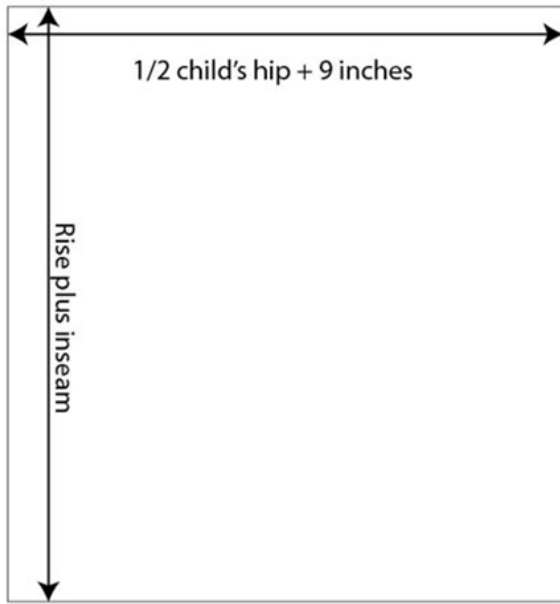

Fig.2.6.8(a): Pant Drafting

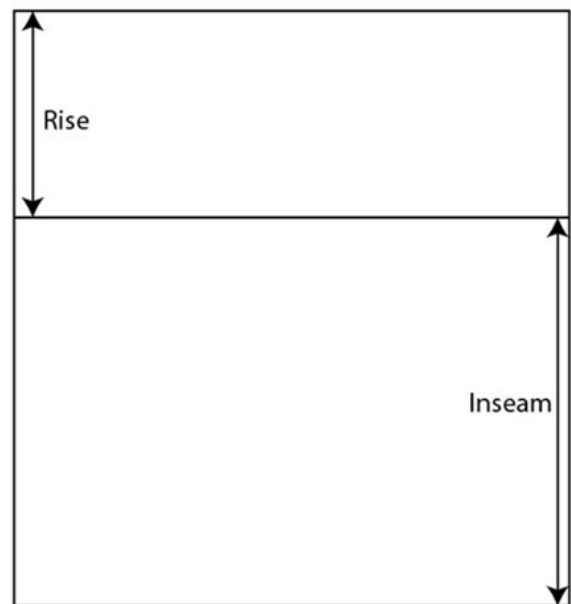

Fig.2.6.8(b): Pant Drafting

Draw a line across the rectangle between the inseam and rise lengths. Bring the sides of the rectangle in as shown at the rise line. The 1" side is the front of the pants, the 2" side is the back.

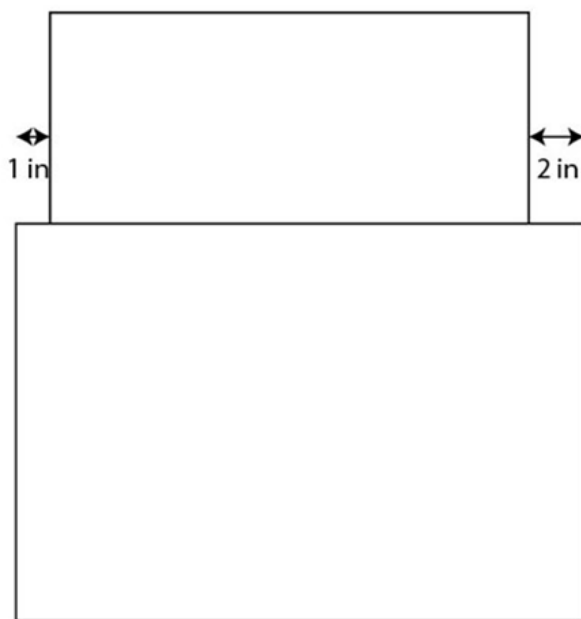

Fig.2.6.9(a): Pant Drafting

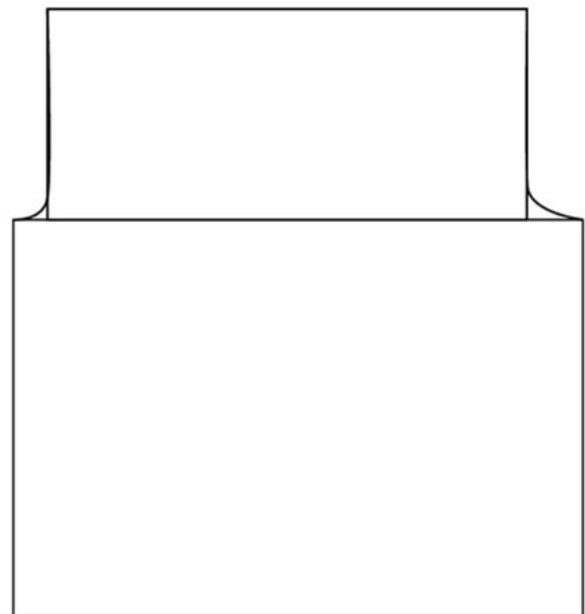

Fig.2.6.9(b): Pant Drafting

Curve the corners to create the crotch lines. At the front edge, drop the line 2 inches and redraw it - this way the waist will cover your kid's booty but not come up uncomfortably high in the front.

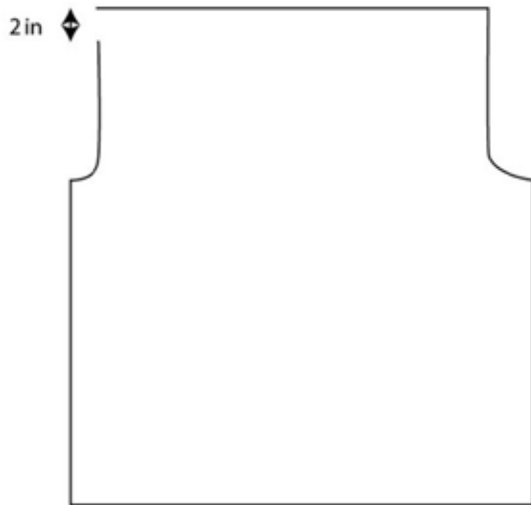

Fig. 2.6.10(a): Pant Drafting

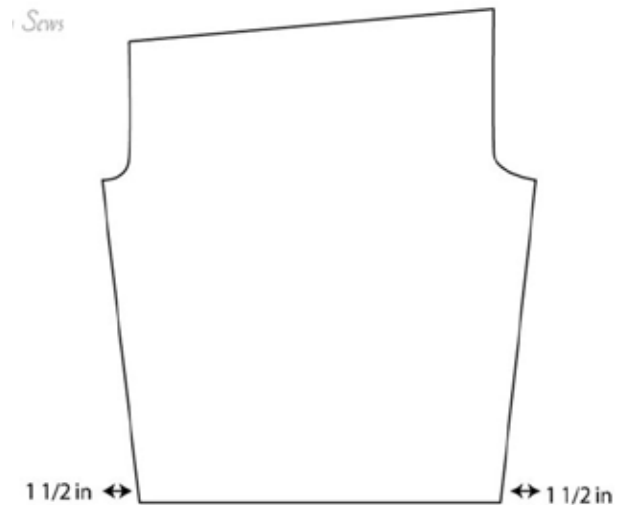

Fig. 2.6.10(b): Pant Drafting

Bring the bottom corners of each pants leg in 1 1/2". Measure the waistline - you'll need that measurement to create the waistband.

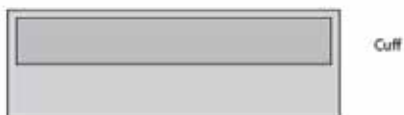
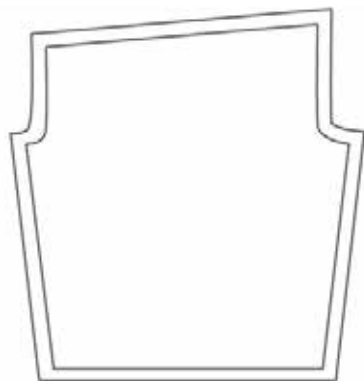

Fig. 2.6.12: Pant Drafting

The waistband will be cut on the fold, so add a seam allowance to the top and side edge, then double this rectangle in height for the final waistband piece (because it will be folded in half to form the casing).

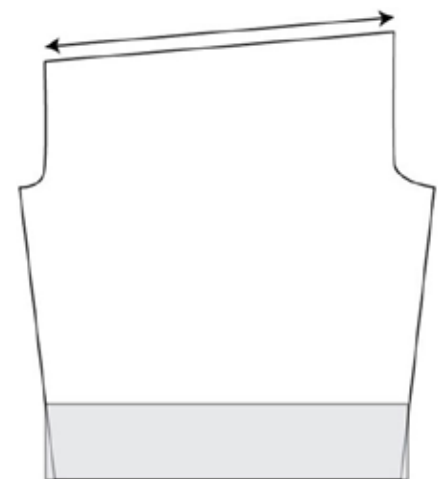

Fig. 2.6.11: Pant Drafting

If you want cuffs, trace out a rectangle that covers the part of the pants you want to be the cuff. Don't follow the angle of the pants leg at the bottom; keep your rectangle with 90 degree corners. Cut off your pants pattern at this line, separating the pants and the cuff. Add seam allowances all around the pants piece.

## Industry Visit

The purpose of visiting a tailor shop/boutique is to get hands on knowledge about various processes involved in the work of a tailor. During the visit you have to interact with Tailors and owner of the shop to understand how work is done in a tailor shop/boutique. Make sure that you keep a notebook handy and note down any important points that come up during your interaction at the tailor shop/boutique. When you go to an tailor shop/boutique, you should:

- Understand drafting and cutting.
- Gather the information about the material equipment and measurement required for drafting and cutting.
- Analyse how a tailor do drafting and cutting of long sleeve shirt, saree blouse, kurta/kameez and pant.
- Ask questions to Tailors/shop owners if you have any query.

## UNIT 2.7: Types of Fabric Defects

### Unit Objectives

At the end of this unit, participants will be able to:

- Understand different types of defects.
- Find and rectify the defects.
- Identify different types of faults.

### 2.7.1 Categories of Defects

Defects are categorised under three main areas

- **Critical defect:** A defect which makes the garment unsafe for individual consumption or it contravenes any mandatory regulations
- **Major defect:** An obvious defect in the appearance which reduces the usability and sale ability of the garment.
- **Minor defect:** A defect which is caused by a workmanship error beyond the quality standards but does not reduce the sale or consumption of the product.

Fabric Defects	Major	Minor
Different weight / handle of fabric than approved sample	<b>HOLD</b>	
Different weight / handle of fabric than approved sample	<b>M</b>	
Drill hole showing	<b>M</b>	
Fabric faults not evident on sample (eg: cuts, holes, tears, thin spots, runs, mispicks slubs, snags, nepping, weaving faults)	<b>M</b>	<b>m</b>
Hole created in fabric when ticketing	<b>M</b>	
Pattern, stripes, checks do not match as specified	<b>M</b>	<b>m</b>
Permanent creases on fabrics, streaks, barre	<b>M</b>	<b>m</b>
Bowing or skewing on plain fabrics more than 2.5 cm per garment width or length	<b>M</b>	
Bowing or skewing on plain fabrics up to 2.5 cm per garment width or length		<b>m</b>
Nap or pile deformation	<b>M</b>	



<b>Shading Defects</b>	<u>Major</u>	<u>Minor</u>
Shade variations between panels	<b>M</b>	<b>m</b>
Shade variation of garment fabric and trims within the garment	<b>M</b>	
Shade variation of garment fabric and trims within the garment	<b>HOLD</b>	
Dye streaks & barre marks at critical zone	<b>M</b>	
Different batches within the order	Comm't	
<b>Cleanliness</b>	<u>Major</u>	<u>Minor</u>
Spots, stains and soil marks	<b>M</b>	<b>m</b>
Threads ends untrimmed	<b>M</b>	<b>m</b>
Excessive fly or contamination on garment	<b>M</b>	
<b>Component parts and assembly</b>	<u>Major</u>	<u>Minor</u>
Missing parts	<b>M</b>	
Missing operation	<b>M</b>	
Operations not done per approved sample and specification	<b>M</b>	
Misalignment of parts, pockets, flaps, trims more than 7 mm	<b>M</b>	
Inconsistent nap directions if specified	<b>M</b>	
<b>Seams and Stitching</b>	<u>Major</u>	<u>Minor</u>
Open seam	<b>M</b>	
Skipped chain stitch	<b>M</b>	
Incomplete seams (two or more stitches)	<b>M</b>	
Double stitching gap 5 mm or more	<b>M</b>	
Needle holes		<b>m</b>
Needle damage	<b>M</b>	
Garment parts caught in unrelated seam distorting fit appearance	<b>M</b>	
Improper stitch tension that affects appearance	<b>M</b>	
Raw edges (other than specified) outside	<b>M</b>	
Edge stitching irregular affecting appearance	<b>M</b>	
Untidy mending	<b>M</b>	
Piecing or joining of binding on critical zone of garments	<b>M</b>	
Monofilament yarns being used as a sewing thread in any stitching / including label stitching	<b>M</b>	
Seam twisted, puckered or pleated affecting appearance	<b>M</b>	

<b>Pressing</b>	<u>Major</u>	<u>Minor</u>
Burned or scorched	M	
Over pressed to leave seam impression	M	
Stretched or distorted during pressing	M	
Excessive wrinkles that require pressing		m
Serious shine caused by improper pressing	M	
Pressed poorly or not pressed at all	M	
Over pressed on improperly finished to deform shapes, designs	M	
<b>Label, Hangtags and Embroidery</b>	<u>Major</u>	<u>Minor</u>
Missing or wrong tags, hangtags, price tags etc.	M	
Missing care, content and country or origin and main label	Reject	
Hangtags insecurely attached or misplaced		m
Wrong main label	Reject	
Label sewn with monofilament yarn	M	
Label sewing thread does not match colour of the garment	M	
Label sewing seam uneven, puckered and 5 mm away from label edge		m
Harsh and stiff label compared to approved label (children wear)	M	
Harsh and stiff label compared to approved label (adult wear)		m
Label omitted or insecurely attached	M	
Fibre label does not meet Labelling legal requirement	M	
<b>Pockets</b>	<u>Major</u>	<u>Minor</u>
Not in specified location more than 7 mm	M	
Shaped poorly	M	
Sewn crooked	M	
Not of specified size and shape	M	
Edge stitching not uniform		m
Flaps not properly placed	M	
Puckers at flat joints	M	
<b>Collars and Cuffs</b>	<u>Major</u>	<u>Minor</u>
Fullness or puckers at collar attachment	M	
Collar points not uniform and balanced	M	
Serious puckers on collar joining	M	
Misaligned or crooked collar settings more than 2 mm	M	
Misaligned or crooked collar setting less than 2 mm		m
Puckered or crooked top stitching	M	

<b>Closure</b>	<u>Major</u>	<u>Minor</u>
Buttons missing or damaged	<b>M</b>	
Buttons misplaced or misaligned causing poor appearance	<b>M</b>	<b>m</b>
Buttons not sewn securely	<b>M</b>	
Buttons not in specified, type or colour	<b>M</b>	
Button holes omitted or added	<b>M</b>	
Button holes uncut	<b>M</b>	
Button holes not sewn securely (easily unravels)	<b>M</b>	
Defective snaps or fasteners that do not function	<b>M</b>	
Misalignments of fasteners causing bad appearance	<b>M</b>	
Snaps or grommets that are not properly set	<b>M</b>	
Snaps that do not fasten properly or release very easily	<b>M</b>	
Improper sippers setting causing wavy and bumpy appearance	<b>M</b>	
Wrong size, type or colour zippers	<b>M</b>	
Defective zipper slides	<b>M</b>	
Defective zipper stops on open front jackets	<b>M</b>	
Tight clearance between slides and seam edge causing difficult slider operation	<b>M</b>	<b>m</b>
Rivets not properly and securely set	<b>M</b>	
Rivets with rough edges	<b>M</b>	
<b>Finishing and Hand-feel</b>	<u>Major</u>	<u>Minor</u>
Permanent wrinkles or deformation on the garment	<b>M</b>	
<b>Folding and Packaging</b>	<u>Major</u>	<u>Minor</u>
Not as specified per product specification	<b>M</b>	
<b>Measurements</b>	<u>Major</u>	<u>Minor</u>
Any measurements beyond specified tolerance	<b>M</b>	<b>m</b>
<b>Design and Colour way</b>	<u>Major</u>	<u>Minor</u>
Not according to approved sample or specification	<b>HOLD</b>	
<b>Weight</b>	<u>Major</u>	<u>Minor</u>
Beyond specified tolerance	<b>M</b>	
Less than specified tolerance	<b>HOLD</b>	
<b>Gauge</b>	<u>Major</u>	<u>Minor</u>
Knitted on different gauge machine	<b>M</b>	

Shipping Carton Mark	Major	Minor
Wrong or incomplete shipping carton markings	<b>HOLD</b>	

Fig.2.7.1: Different types of defects

### Examples of Critical Defects

S No	Critical Defects
1	Loose components: Trims and fasteners those are used in the garment but not secure properly. For example, buttons, snaps, stones etc
2	Sharp edges: During the processing of the garment it come in contact with various sharp metals such as needles, staples. Broken needles, damaged or broken snap buttons, rivets, wire and pins.
3	Drawstrings at head or neck for baby or kids products. Draw string must be avoided in kids clothes.
4	Thread or trims which are extensively long or loose

Fig.2.7.2: Examples of Critical Defects

## 2.7.2 Factors to be Considered

Factors to be considered for classification of defects

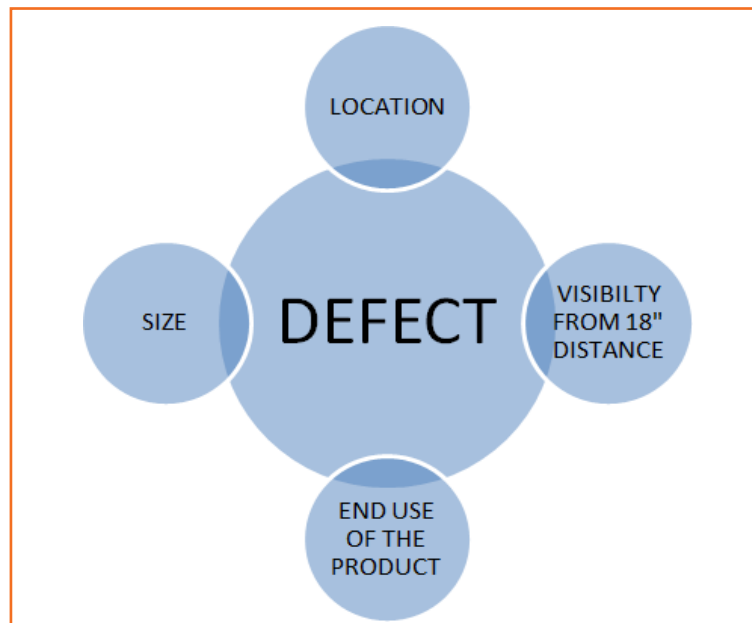

Fig.2.7.3: Classification of defects

## 2.7.3 Types of Faults and Defects

The different types of faults and defects found in garments can be catogorised as:

- Preproduction Defects
- Stitching Defects
- Fabric Defects

## Preproduction Defects

### Pattern Making Defects

- Shaded parts
- Mismatched Plaids
- Marker too wide or narrow
- Unsymmetrical pieces
- Poor line definition (e.g., chalk line too thick or thin)

### Spreading Defects

- Improper matching or the material is facing the wrong way
- Material too narrow or wide
- Improper tension-Material spread too tight or loose
- Narrow material-Marker width is not covered because the material is too narrow

### Cutting Defects

- Improper cutting: Not following the pattern and marker lines,
- Frayed or unsharpened knife: Causes uneven or frayed edges.
- Notches: Too deep or shallow or completely omitted.
- Drill Marks: Not perpendicular, omitted or wrong drill used.
- Mixed piles: Resulting in shaded garment part when assembled

### Bundling and Ticketing faults

It is very necessary to ensure numbering, sorting and bundling of the cut products is done properly. If it is not done accurately it might result in mismatched products. For example if the lining materials are not numbered and stacked properly, it might be wrongly used on a garment.

Fig.2.7.4: Preproduction Defects

### Fabric Defects

**Coloured flecks** : This is caused due to the presence of foreign material in the yarn

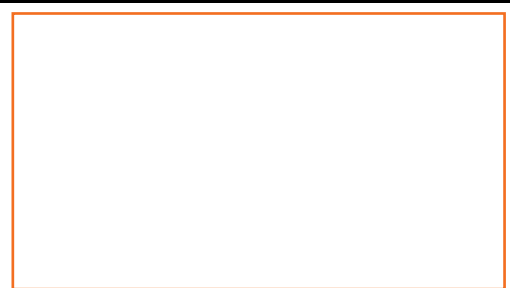

**Knots**: Knots are caused when the thread breaks during the process of winding or weaving of the yarn. This is a non-mendable defects.

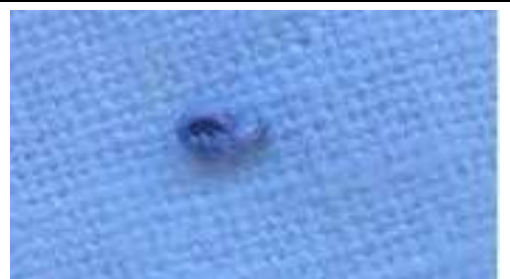

<p><b>Broken pattern:</b> When there is a non-continuity in the pattern, design or weave caused due to the non-drawing in of threads</p>	
<p><b>Hole, cut or tear:</b> are caused due to various factors such as sharp edges on cloth roll, using the wrong kind of cutting material, hard substance between layers of fabric etc.</p>	
<p><b>Untrimmed loose threads:</b> Is caused if the tail ends are not trimmed after piecing up. This defect can easily be rectified with the help of clippers.</p>	

Fig.2.7.5: Fabric Defects

### Stitching Defects

<p><b>Skipped Stich:</b> The common cause for this would be if the machine is incorrectly threaded, the needle is damaged, Needle is not suitable for the thread used, Thread is too fine or thick, Fabric is not held correctly.</p>	
<p><b>Thread Breaks:</b> If poor quality thread is used, improper setting of needle and bad quality needle, Machine is dirty and thread is inserted incorrectly, Machine operator did not release tension before removing the material.</p>	
<p><b>Seam pucker :</b> Happens if the fabric is very light, not held properly and too tightly woven. Also if the thread is of wrong size and is too tight. If the needle needs replacing, the thread and needle do not go together.</p>	



**Excessive Seam Grin:** Occurs when the sewing machine thread is not inserted properly and there is a tension



**Re stitched seams/Broken Stitches:** Is caused if the thread breaks or the machine runs out of thread during sewing or happens during the treatment of the finished product.



**Open seam:** Is caused if the thread strength is inadequate and if there is not enough stitches per inch.

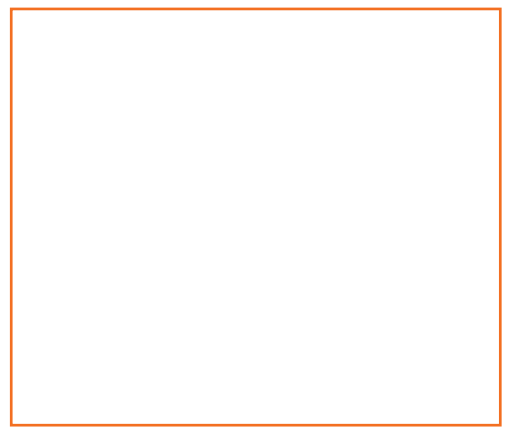

**Seam failure:** Is caused if the fabric is weak or loosely constructed.

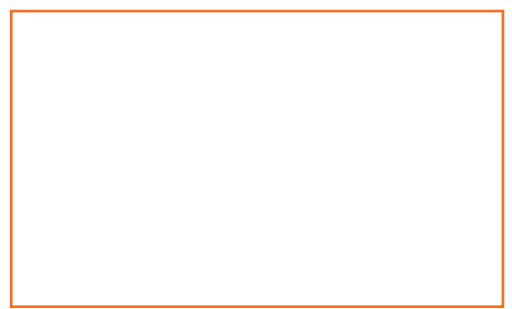

**Improper stitch balance:** Bad quality thread, the bobbin thread tension is not set correctly and the minimum straight to get a balanced stitch is not obtained.

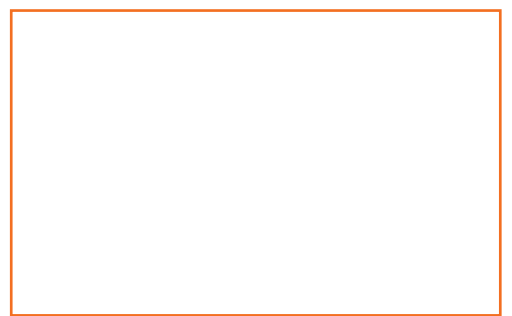

**Ragged Edge:** Caused when the sewing machine knives are not sharpened and changed often



Fig.2.7.6: Stitching Defects





**Example of faults and their remedies**

Location	Defects	Causes	Remedies
Collar	Both points are not aligned.	Pattern mistake	Proper pattern marking
	strip or check is not match accurately/stitch	Pattern mistake	Proper mitering
	collar flat or not	Improper Stitch/seam	Proper folding & stitching
Size	Incorrect size parts	Improper ticketing & bundling	Proper ticketing & bundling
Button & button hole	Not placed in right place	Improper marking	Proper marking
	unevenness of gap between one button to other	Improper measuring & marking	Proper marking
	stitch is done correctly/ extra thread	Improper stitching/ machine settings	Proper setting of machines
	broken button	Improper inspection	Replace
Sleeve	Unequal size	Improper measurement/stitching	Proper measurement, marking, & stitch.

Fig.2.7.7: Shirt Inspection Checklist

**Woven Fabric Defects**





Defect	Explanation	Severity	Photograph
<b>Defects of Woven Fabric</b>			
Dropped Pick	Caused by the filling insertion mechanism on a shuttle less loom not holding the filling yarn, causing the filling yarn to be woven without tension. The filling yarn appears as "kinky."	Major	

End Out	Caused by yarn breaking and loom continuing to run with missing end.	Major	
Slub	Usually caused by an extra piece of yarn that is woven into fabric. It can also be caused by thick places in the yarn. Often is caused by fly waste being spun in yarn in the spinning process.	Major or Minor	
Knots	Caused by tying spools of yarn together	Usually Minor	
Mixed End (Yarn)	Yarn of a different fiber blend used on the wrap frame, resulting in a streak in the fabric.	Usually Major	
Mixed Filling	Caused by bobbin of lightweight yarn or different fiber blend used in filling. Will appear as a distinct shade change	Major	



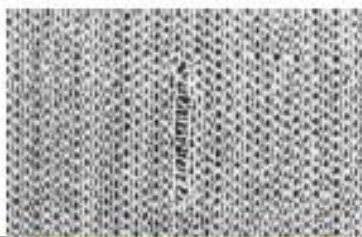

Soiled Filling or End	Dirty, oil looking spots on the wrap or filling yarns, or on package-dyed yarn	Major	
-----------------------	--	-------	--

Fig. 2.7.8: Woven Fabric Defects

### Other Knitted Fabric Defects

Drop Stitches	Results from malfunctioning needle or jack. Will appear as holes or missing stitches.	Major	
Hole	Caused by broken needle.	Major	
Missing Yarn	Occurs in circular knit. Caused by one end of yarn missing from feed and machine continuing to run.	Major	
Mixed Yarn	Occurs in wrap knit. Results from wrong fiber yarn (or wrong size yarn) placed on wrap. Fabric could appear as thick end or different color if fibers have different affinity for dye.	Major	

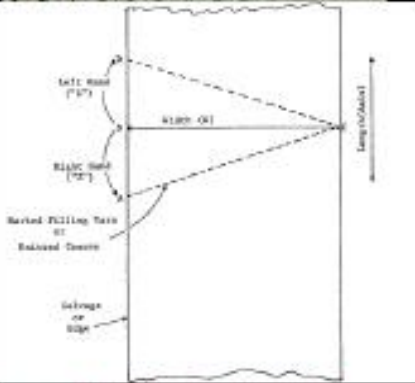

Needle Line	Caused by bent needle forming distorted stitches. Usually verticals line.	Major or Minor	
Runner	Caused by broken needle. Will appear as vertical line. (Most machines have a stopping device to stop machine when a needle breaks.)	Major	
Slub	Usually caused by a thick or heavy place in yarn, or by lint getting onto yarn feeds.	Major or Minor	
Askewed or Bias	Condition where filling yarns are not square with warp yarns on woven fabrics or where courses are not square with wale lines on knits.	Major or Minor	
Pin holes	Holes along selvage caused by pins holding fabric while processes through stenter frame	Major if extends into body of fabric	
Straying End	Caused when an end of yarn breaks and loose end strays and is knit irregularly into another area.	Major	





Bowling	Usually caused by finishing in knits ,the course lines lie in an arc across width of goods.	Major on stripes or patterns Minor on Solid color	
---------	---	--	--

Fig. 2.7.9: Knitted Fabric Defects

**Accessory Defects**

ZIPPERS		
Slider defect	<p>Won't Lock: Not apparent without testing by placing Zipper slider in locked position and applying tension. Faulty Dimension: Not readily apparent. May cause either a hard or a loose operating zipper. Either condition may result in zipper failure before garment is worn out. Crushed Slider: May be due to improper garment pressing or due to padding or compensating springs in the presses not being in best condition. Tarnished: Does not generally interfere with operating qualities but is a matter of appearance only. Judging" this as a defect depending upon degree of tarnish. Burn or Rough Spots Not immediately apparent. Can cause snagging and early wear on the upper tape. Lock Prong Interferes Indicated by pull-tab not staying in locked position or slider not moving freely after being released from locked position. Weak Slider Bodies: Can best be determined with proper testing equipment. However, manifests itself by slider becoming compressed or crushed under minimum pressure or becoming distorted enough to create hard operation.</p>	
Chain or Teeth Defect	<p>Improper Dimensions: Not always apparent unless slider works with great difficulty or operates too easily. Zipper' may give initial satisfactory operation but fail after only moderate use and especially after laundering or dry cleaning. Miss meshed and Unmeshed Teeth: Readily Cord not</p>	

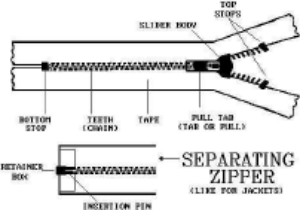

	<p>visible, particularly in large. Usually results in inoperable zipper. Missing Teeth: Readily visible, will result in early failure of the zipper. Misplaced Teeth: This refers to a tooth being out of position, and occasionally may involve two or three teeth. Seriousness ranges from trifling to almost as serious as a missing tooth depending upon the degree of misplacement and general design of zipper. Off color: This defect is quite apparent. Zipper manufacturers normally carry a complete range of tape colors. Due to similarity of different colors, one may be mistaken for another. It is also possible, because of color similarities or difference in dye lots that the two halves of the zipper will have two different shades of tape. Humpy Chain: Readily noticeable by its waviness. Causes difficulty at sewing operation and distorts finished garment's appearance. Attached to Tape: Due to skipped stitches during operation of sewing cord to tape. Not readily apparent but under strain, cord and teeth will rip away from tape and render zipper and garment unusable. Length: Improper zipper length for given opening.</p>	 
<p>Top or Bottom Stop Defects</p>	<p>Missing Top or Bottom Stop: Readily apparent and will result in zipper failure. If facilities for attaching a top or bottom stop are not available, then the entire zipper should be replaced. In some instances, bottom stops are attached at garment plant. An improperly or poorly attached bottom stop may be result of carelessness on part of the operator or of improper functioning of the bottom stop machine.</p>	
<p>Snap fasteners</p>		
<p>Hard Action:</p>	<p>In light-weight goods this may result in stud or socket pulling through the material. The snap fastener manufacturer can be of help in recommending proper tension of stud in socket for weight of garment material.</p>	
<p>Light Action:</p>	<p>Snap fastener does not stay closed because of lack of proper tensions. Same comment applies as for tight closure.</p>	



<p>Hooks &amp; Eyes</p>	<p>Improperly Applied: This is usually caused by a careless operator or improperly adjusted attaching equipment, and corrections are usually simple when apparent. Improper Alignment: Gauges are available for attaching equipment to assure proper alignment in positioning. This is a necessary if garment is to have a properly tailored look. If the top of the zipper is extended into the waistband of the trouser, than the hook and eye should be offset to prevent it from hitting the zipper material.</p> <p>Poor Finish: May be the result of improper finishing or pocking of the metal surface and, while this defect dose not interferes with the functional operation, it may not leave the desired finished appearance of the garment. Tight/ Loose Closure: Attaching equipment ill fitted with an adjustable feature permitting secure application of hook and eye to either light or heavyweight goods. If closures seem too tight, then one should immediately check the attaching equipment for proper adjustment.</p>	
<p>Buttons</p>		
<p>Rough or Dull Surfaces</p>	<p>This is not a serious fault except in cases of extreme roughness or poor surface appearance.</p>	
<p>Non-Uniformly Spaced or Chipped or Blocked Sew Hole:</p>	<p>This type of defects cannot be noted during the garment manufacturing operation and can slip inspection unnoticed but it frequently causes needle breakage or cut thread.</p>	

Fig.2.7.10: Accessory Defects

## 2.7.4 Rectification of Defects

Few common stitching defects encountered by in-line checkers and their causes are listed below:

Improper Stitching	Incorrect threading Bent needle head
Improper feeding	Insufficient or too much pressure on pressure foot. Stitch length too short.
Skip stitching	Incorrect threading Damaged needle Larger needle hole Improper thread tension- too tight /thread stretches when heated.
Skip stitching (over edge machine)	Loopers are incorrectly set Needle to looper setting is incorrect Wrong thread type
Wavy Seam	Stitch length too short Pressure too heavy or light
Wavy Seams (overedge machine)	Different feed needs increasing
Piles Feed unevenly	Incorrect pressure on the pressure foot Piles lock or stitch together Feed dog at incorrect height Inappropriate pressure-foot Inappropriate needle plate
Unbalanced Tension	Different thread on needle and bobbin Thread slipped out of tension disc Incorrect threading Poor quality thread Bent, rusted or incorrect bobbin/improperly or unevenly wound bobbin/ bobbin have several layer of thread/bobbin case screw has worked out.
Unbalanced Tension (over edge Machine)	Low power tension needs adjustment
Uneven Stitches	Thread does not feed smoothly/thread has wrong twist/thread incorrectly threaded between tension discs. Pressure too tight
Cracked Seam	Lint between the tension discs, guides or eyelets Bobbin or looper thread tension too tight Needle too small or wrong point Threads not moving smoothly through guides or eyelets. Threads are too thick for needle or machine has rough spots.

Thread Breakage	<ul style="list-style-type: none"> <li>Poor quality thread</li> <li>Tension too tight</li> <li>Needle set improperly</li> <li>Needle needs replacement</li> <li>Pressure bar not down</li> <li>Rough needle eye, throat plate or thread spindle</li> </ul>
Seam grin	<ul style="list-style-type: none"> <li>Stitch length too short</li> <li>Thread not set into tension discs properly</li> <li>Tension on needle thread too loose</li> </ul>
Machine Jam	<ul style="list-style-type: none"> <li>Machine is incorrectly threaded</li> <li>Needle set incorrectly or damaged</li> <li>Static electricity pulls fabric into needle hole</li> <li>Bobbin inserted incorrectly</li> </ul>
Un threading of needle	<ul style="list-style-type: none"> <li>Thread end too short</li> <li>Take-up lever is not at highest position</li> </ul>
Needle Breakage	<ul style="list-style-type: none"> <li>Needle needs replacment or set incorrectly</li> <li>Pressure foot too loose</li> <li>Bobbin or bobbin case incorrectly set</li> <li>Pulling fabric while stitching or without raising pressure foot.</li> <li>Fabric too thick</li> </ul>
Bobbin Thread breakage	<ul style="list-style-type: none"> <li>Improperly threaded machine</li> <li>Bobbin tension too tight</li> <li>Bobbin too full</li> <li>Bobbin pigtail caught in bobbin-case</li> <li>Bobbin screw not working properly</li> </ul>

*Fig.2.7.11: Common stitching defects*

### Process to Rectify Few Defects

Re-stitched Seams / Broken Stitches	Using better quality sewing threads Ensure proper machine maintenance
Open Seam – Seam Failure – Stitch	Better quality threads Proper size thread for application Proper tension
Seam Slippage	Change seam type if possible Increase seam width Optimize the stitches per inch.
Excessive seam Puckering	Correct thread type and size. Sew with minimum sewing tension to get a balanced stitch Machine needle, bobbin and threads are set properly according to the fabric to be sewn.
Knits & Stretch woven puckering	Set the machine properly according to the fabric Minimum pressure foot pressure
Improper Stitch balance – 301 Lockstitch	Use quality thread Properly balance the stitch so that the needle and bobbin threads meet the middle of the seam. Always start by checking bobbin tension to make sure it is set correctly, so that minimum thread tension is required to get a balanced stitch
Improper Stitch balance – 401 Chain stitch	Use quality thread Properly balance the stitch so that when the looper thread is unravelled , the needle loop lays over half way to the next needle loop on the underside of the seam
Improper Stitch balance – 504 Overedge Stitch	Use Quality thread Properly balance the stitch so that when the looper thread is unravelled, the needle loop layover half way to the next needle loop on the underside of the seam
Raggeded/Inconsistent Edge	Make sure the sewing machine knife are sharpened and changed often The knives should be adjusted properly in relationship to the “stitch tongue” on the needle plate to obtain the proper seam width

Fig.2.7.12: Process to Rectify Few Defects

## 2.7.5 Fabric Care

The proper care of clothes ensures that the garments last longer and gives one value for money and look great after a number of washings

### Safe Ironing temperatures limits for fabrics

Cotton	400 o -425o F
Linen	450 o F
Silk	300 o F
Wool	300 o F
Nylon	300 o -350 o F
Polyester	325 o F
Rayon	350 o -375 o F (Reverse and iron)
Rubber	Do not iron

Fig.2.7.13: Safe Ironing temperatures limits for fabrics

## Industry Visit





The purpose of visiting a tailor shop/boutique is to get hands on knowledge about various processes involved in the work of a tailor. During the visit you have to interact with Tailors and owner of the shop to understand how work is done in a tailor shop/boutique. Make sure that you keep a notebook handy and note down any important points that come up during your interaction at the tailor shop/boutique. When you go to an tailor shop/boutique, you should:

- Inspect stitched products against specifications.
- Analyze how tailors:
  - » Inspect stitched products against specifications
  - » Carryout alterations
  - » Sew and apply trims by hand and machine
- Also Understand the inspection and possible defects.
- Ask questions to Tailors/shop owners if you have any query.



## Resources

Scan the QR codes or click on the link to watch the related videos.

Descriptions	QR Codes
Tools and equipment used in sewing	 <a href="https://youtu.be/_2ZLtGfBJrY">https://youtu.be/_2ZLtGfBJrY</a>
Garments measurement system	 <a href="https://youtu.be/Ki8T_KEg81Q">https://youtu.be/Ki8T_KEg81Q</a>
Bodice Pattern With Darts	 <a href="https://youtu.be/xR-59vVNaxU">https://youtu.be/xR-59vVNaxU</a>
Categorization of garment defects	 <a href="https://youtu.be/SPtD6mAZ0GU">https://youtu.be/SPtD6mAZ0GU</a>

## Exercise

1. is available in a rainbow of colours, including clear.
  - a) Scissors
  - b) Thread
  - c) Pins
  - d) Needles
2. An iron is used for pressing the fabric, making darts and opening seams.
  - a) True
  - b) False
3. is a 6 inch gauge with a movable indicator convenient for measuring short lengths.
  - a) Hem gauge
  - b) Meterstick
  - c) Sewing gauge
  - d) Hip curve
4. Greyscale is used for matching colours in the sewed garment against the specifications.
  - a) True
  - b) False
5. What are the use of tailor chalk?
  - a) Pattern marking
  - b) Information writing
  - c) Designing
  - d) Non of these
6. What is the use of tracing paper?
  - a) Pattern marking
  - b) Design Transfer
  - c) Both A & B
  - d) Non of these
7. is a sheer fabric with a free flowing drape and crepe like structure.
  - a) Velvet
  - b) Chiffon
  - c) Satin
  - d) Silk
8. Corduroy is a thick fabric which is very warm and durable.
  - a) True
  - b) False

9. Denim is made from tightly woven cotton.
  - a) True
  - b) False
10. Silk is a Natural Fabrics?
  - a) True
  - b) False
11. Organza fabric is light weight fabric.
  - a) True
  - b) False
12. Trims and accessories increase the usability of the garment.
  - a) True
  - b) False
13. is a delicate fabric which is made either of thread or yarn.
  - a) Interlining
  - b) Lace
  - c) Label
  - d) None of the above
14. Piping is used to stabilize seams, outline components and absorb the wear and abrasion to the seam.
  - a) True
  - b) False
15. Braids are not used for decoration on garments.
  - a) True
  - b) False
16. Main label carries:
  - a) Brand Name
  - b) Garment Size
  - c) Country of origin
  - d) All of the above
17. Measuring tape is a common measuring tool used by all tailors.
  - a) True
  - b) False
18. Inches are the long lines that cross either half of, or all of the 1" width of the measuring tape.
  - a) True
  - b) False
19. Trousers size 40 refers to:

- a) Waist Size
  - b) Length of Trousers
  - c) Crotch Size
  - d) None of the above
20. Which of the followings are the types of measurement:
- a) Across back
  - b) Shoulder to neck
  - c) Hips
  - d) All the above
21. For measuring the neck the measurement tape should be held around the neck line and just below the Adam's apple.
- a) True
  - b) False
22. How will you measure crotch?
- a) CF to CB
  - b) CF to SS
  - c) High Hips to Waist
  - d) All the above
23. How will you take the measurement of waist?
- a) CF to CB
  - b) CF to CF Round
  - c) CF to SS
  - d) All the above
24. Darts are used to give fit or shape to the garment.
- a) True
  - b) False
25. Which of the followings are the types of faults and defects:
- a) Stitching
  - b) Fabric
  - c) Preproduction
  - d) All the above





## 3. The Sewing Process

Unit 3.1 - The Sewing Process

Unit 3.2 - Stitching

Unit 3.3 - Knowledge of Basic Embroidery Stitches





## Key Learning Outcomes

**At the end of this module, participants will be able to:**

1. Recognize the different types of sewing machine and understand the different parts of a sewing machine.
2. Thread a sewing machine.
3. Explain the different hand sewing methods.
4. Identify flat stitches, loop stitches and knotted stitches.
5. Carry out flat stitches, loop stitches and knotted stitches.

## UNIT 3.1: The Sewing Process

### Unit Objectives

At the end of this unit, participants will be able to:

1. Recognize the different types of sewing machine and understand the different parts of a sewing machine.
2. Thread a sewing machine.
3. Explain the different hand sewing methods.

### 3.1.1 Types of Sewing Machines

In accordance with the job requirement, the tailor uses different types of sewing machines. These machines have to be chosen and handled with care to provide best results.

**Lockstitch sewing machine:** Also called the domestic sewing machine, this is a regular and popular machine which is used at home and also in schools. It is run manually but also can be converted to electric power machine.



Fig.3.1.1(a): Hand driven Domestic sewing machine



Fig.3.1.1(b): Peddle driven Domestic sewing machine



Fig.3.1.2: Single needle lock stitch machine

**Single needle lock stitch machine:** It is modern high quality the color LCD touch panel sewing machine which reduces the disposition of the thread ends.

**Embroidery Machine:** This is used in making diverse kinds of embroidery and fancy stitches on fabrics. This machine is popularly used in making pillow cases, linen, and other novelty.



Fig.3.1.3: Embroidery Machine



Fig.3.1.4: Button Holer Machine

**Button Holer Machine:** As the name of the machine suggests. This is used in making buttonholes on garments.

**Button Attachment Machine:** This machine is used in attaching buttons to the garments



Fig.3.1.5: Button Attachment Machine



Fig.3.1.6: Bartacking Machine

**Bartacking Machine:** This is used in reinforcing the opening and closing of pockets.

**Double needle lock stitch Machine:** It works similar to the single needle lock stitch machine, using double needles and bobbins thus resulting in two parallel rows of lockstitch. The distance between the two stitches lines depends upon the distance between the two needle bars which can be adjusted.



Fig.3.1.7: Double needle lock stitch Machine

### 3.1.2 Parts of a Basic Sewing Machine and Their Functions

It is important for the beginner to know and recognize the different parts of the sewing machine. The basic structure of a hand operated or electric sewing machine are the same.

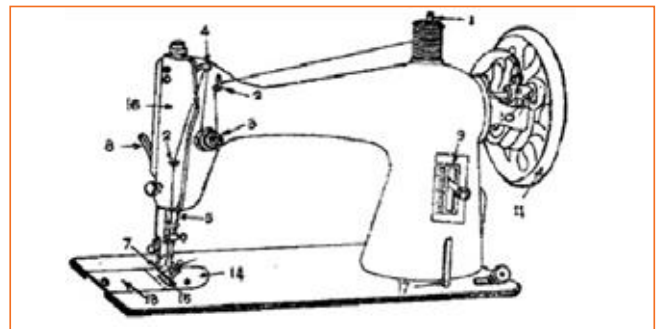

Fig.3.1.8: Parts of a Basic Sewing Machine

**Parts of Sewing Machine:**

1. **Spool pin:** While the thread feeds through the machine, the spool pin keeps the spool in place. Some machines have both horizontal and vertical spool pins.
2. **Thread guide:** It holds the thread in position from the spool to the needle.
3. **Tension disc:** The thread passes between the two concave discs put together with the convex sides facing each other. There is a spring and nut which increases or decreases pressure thus adjusting the tension of the thread
4. **Take up lever:** It is a lever fitted to the body of the arm. It's up and down motion feeds the thread to the needle and tightens the loop formed by the shuttle.
5. **Needle bar:** Its main function is to give motion to the needle. The steel rod holds the needle at one end.
6. **Bobbin case:** This moves into position to catch the top thread and form the stitch as the needle is lowered into the bobbin chamber.
7. **Presser foot:** It is fixed to the presser bar and holds the cloth firmly in position when lowered.
8. **Presser foot lifter:** It is a lever attached to the presser bar for raising and lowering the presser foot.
9. **Stitch regulator:** This controls the length of the stitch.
10. **Bobbin winder:** A simple mechanism used for winding thread on the bobbin.
11. **Fly Wheel:** When this is made to revolve, it works the mechanism of the motion
12. **Clutch or Thumb Screw:** This is in the centre of the fly wheel and it engages and disengages the stitching mechanism.
13. **Slide Plate:** A rectangular plate, which facilitates the removal of the bobbin case without lifting the machine.
14. **Needle Plate or Throat Plate:** A semi-circular disc with a hole to allow the needle to pass through it.
15. **Feed dog:** This consists of a set of teeth fitted below the needle plate. It helps to move the cloth forward while sewing.
16. **Face plate:** A cover which on removal gives access to the oiling points on the needle bar, presser bar and take-up lever.
17. **Spool pin for bobbin winding:** Spool of thread is placed on this at the time of bobbin winding.

**Few more parts of the sewing machine are as follows:**

1. **Arm:** The horizontal upper part of the head which has the mechanism for handling upper thread and driving the needle.
2. **Back Stitch Lever:** A lever located at the lower right hand side of the machine and its basic function is to form the stitches in reverse direction.
3. **Bed:** The lower portion of the machine i.e. stands under which the mechanism for handling lower thread including the shuttle and feed are mounted.
4. **Bobbin:** A small metal spool that holds the lower thread supply.
5. **Hand Wheel:** Handel is located on the right side of the machine. It is driven by hand or belt in the domestic machine and with the help of belt in the industrial machine. It controls the movement of the needle bar and drives the machine.
6. **Hand Lifter:** To lift the presser foot by hand.
7. **Head:** The upper part of the machine above the stand. It is a complete sewing machine without the bed.

8. **Pan:** It is the metal pan under the head that catches oil, lint, broken threads.
9. **Shuttle:** A device that carries the needle thread around the bobbin and forms the lock on the lock stitch.
10. **Tension Regulator:** It is a mechanism which controls the tension of upper thread and the quality of stitches. The tension of the thread is adjusted with the help of spring and nut which controls the pressure on the disc.
11. **Thread Stand or Spool Pin:** It is a metal rod fitted either on top or on side of the stand to hold the thread spool.
12. **Thread Take Up Lever:** A bar/lever which is located above the tension regulator. It moves up and down. It has a hole through which the thread passes. It feeds thread to the needle and it also tightens loop formed and locks it.

### 3.1.3 How to Thread a Sewing Machine

1. Put the presser foot in the ascendant position. Place a reel of thread on the spool holder. Roving from the spool holder, diagonally through the top of the machine, look for a smallest of one thread guide. Insert the thread in the thread guide.
2. Look for a tension apparatus. Bring the thread down to the tension mechanism, slip the thread amid the metal disks of the tension mechanism, and port back upwards with the thread.
3. Look for a take up mechanism. This is the area on the anterior of the machine which will go up and down, when you turn the hand wheel. Place the thread over the take up lever. Some machines are set up so the thread will slip into this; others require you to place the thread through a hole.
4. At this time the thread will go downward on the left side of the take up lever.
5. Locate and thread any thread guides, leading down to the sewing machine needle.
6. Thread the sewing machine needle. Grip the thread with your left hand and turn the hand wheel.
7. Watch for any thread to flap about. If this chances, you have probably missed a thread guide.



Fig.3.1.9: Threading a machine

### 3.1.4 Common Sewing Machine Problems

A Tailor should know how to tackle simple sewing machine problem. Below is the checklist for machine problems and the best ways to solve them.

Machine troubles	Causes	Remedies
Skipped stitches	<ul style="list-style-type: none"> <li>• Defective machine needle</li> <li>• Low pressure on the presser foot</li> </ul>	<ul style="list-style-type: none"> <li>• Replace the needle</li> <li>• Increase pressure on the presser foot.</li> </ul>
Knotting or breaking thread	<ul style="list-style-type: none"> <li>• Bad quality thread</li> <li>• Machine is threaded wrongly</li> <li>• Bobbin and Bobbin case is threaded incorrectly.</li> </ul>	<ul style="list-style-type: none"> <li>• Completely un-thread your sewing machine and re-thread it.</li> <li>• Thread it correctly.</li> </ul>

Machine runs noisily	<ul style="list-style-type: none"> <li>• Insufficient oil</li> <li>• Loose screw</li> </ul>	<ul style="list-style-type: none"> <li>• Oil the sewing machine</li> <li>• Tighten the screws</li> </ul>
Thread bunching or "Birds nesting "	<ul style="list-style-type: none"> <li>• Tension setting is too low</li> <li>• The thread is positioned wrongly</li> <li>• The bobbin case is positioned incorrectly</li> </ul>	<ul style="list-style-type: none"> <li>• Reset the tension</li> <li>• Re-thread the top thread ensuring the threading line indicator on the hand wheel is positioned to the top</li> <li>• Check the position of your bobbin case and reset as per instruction manual</li> </ul>
Fabric not feeding	<ul style="list-style-type: none"> <li>• Feed has not been accidentally lowered.</li> <li>• Stitch regulator not set on zero</li> <li>• Too tight pressure on presser foot</li> </ul>	<ul style="list-style-type: none"> <li>• Raise the feed to ensure the fabric will move forward.</li> <li>• Adjust stitch regulator to desired stitch length</li> <li>• Add pressure to presser foot by adjusting the pressure regulator screw</li> </ul>

Fig.3.1.10: Common Sewing Machine Problems and their Solutions

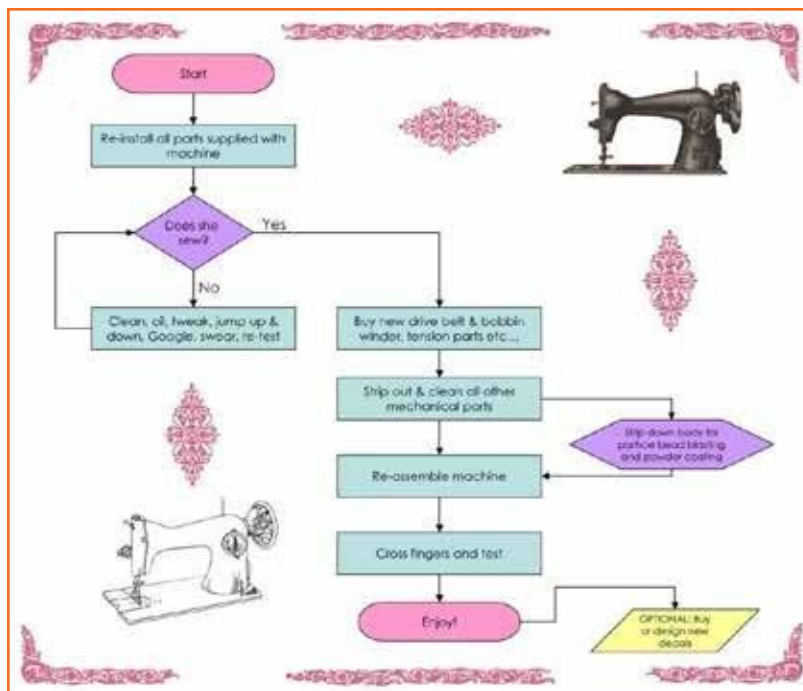

Fig.3.1.11: Solving common problem of a sewing machine

### 3.1.5 Different Hand Sewing Methods

Every tailor should know a few of the basic hand stitching methods. The popularly used hand stitching methods are listed below.



**Running Stitch:** Push point of needle in and out of fabric until you have several stitches on the needle. Hold fabric taut with left hand, pull the needle through. It's the basic stitch in hand-sewing and embroidery, on which all other forms of sewing are based.

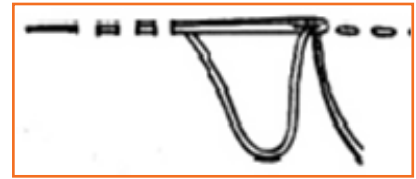

Fig.3.1.12: Running Stitch



Fig.3.1.13: Back Stitch

**Back Stitch:** It is used in strengthening a seam made by hand.

- Make a running stitch
- Take a back stitch to the beginning of the first stitch, overlapping each running stitch

**Basting:** This stitch holds the fabric temporarily in place, until permanently stitched. It is a longer version of a running stitch.

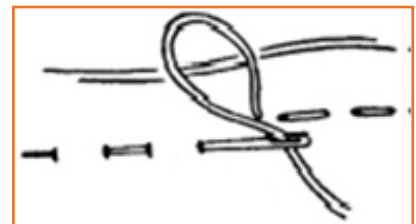

Fig.3.1.14: Basting

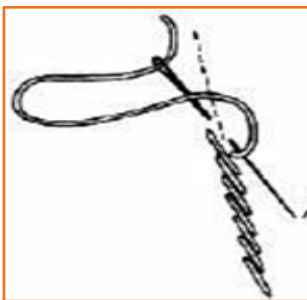

Fig.3.1.15: Outline Stitch

**Outline Stitch:** It is the slanted version of the back stitch. Start with a straight stitch in the fabric, and pull the thread through until you are left with a small loop. This stitch is used to mark outlines in an embroidery pattern.

**Blanket Stitch:** Put your needle in 1/4 inch from the edge of the fabric, put the thread under the point of the needle and pull through. It is used for edging material of table-covers, mantel valances, blankets etc.

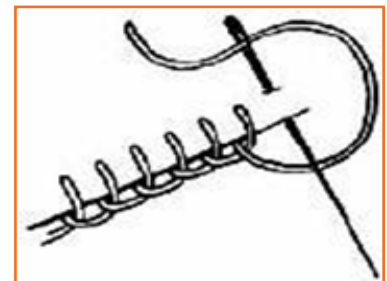

Fig.3.1.16: Blanket Stitch

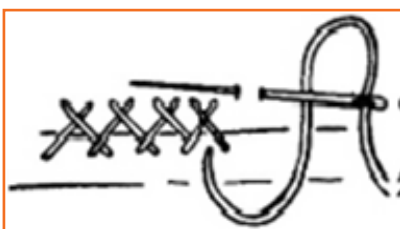

Fig.3.1.17: Catch Stitch

**Catch Stitch:** It is one of the hemming stitches. The catch stitch is an ideal stitch for when you need to hem knit garments. Working from left to right, Take a stitch in the hem, then a tiny stitch to the right just beyond edge of hem with the point of needle to the left. This makes diagonal lined that cross each other.

**Chain Stitch:** Chain stitch is a series of looped stitches forming a chainlike pattern. It is adapted to all different techniques, even lace making. Insert the needle in and out of the fabric (as in the running stitch). Bring the thread under the tip of the needle while still in the fabric, then pull the needle through.

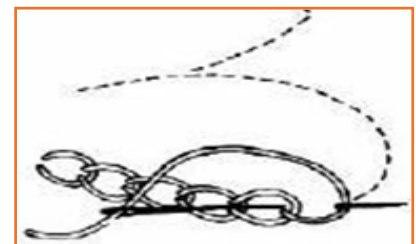

Fig.3.1.18: Chain Stitch

**Padding stitch:** Put at an angle this stitch resembles a temporary stitch. The first line is taken at a certain angle and in the next line the angle is in the opposite direction. Used to set layers of cloth. It is used mainly in coats.

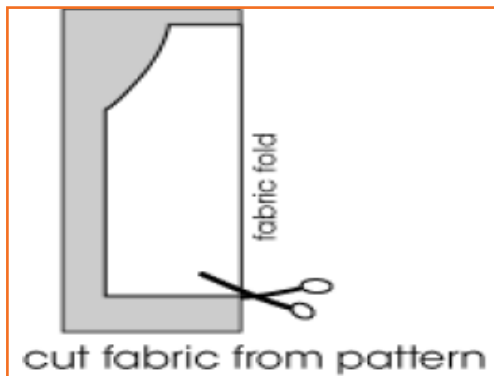

Fig. 3.1.19: Padding Stitch

### 3.1.6 Sequence of Sewing (A Basic Apron with Pocket)

Materials, Tools and Equipment Required:

- 1 yard of fabric
- Piece of coordinating fabric for the pocket
- 7/8" ribbon
- Apron Pattern



**STEP 1:** Place the apron pattern on the folded fabric and cut out.

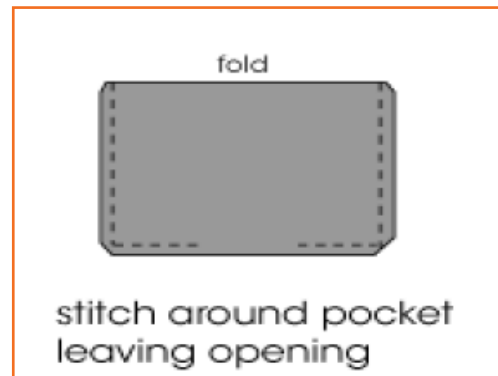

**STEP 2:** Fold the rectangle of coordinating fabric in half with right sides together. Stitch around three sides of the pocket using a 1/2" seam allowance, leaving a 3" opening at the bottom. Clip the corners.

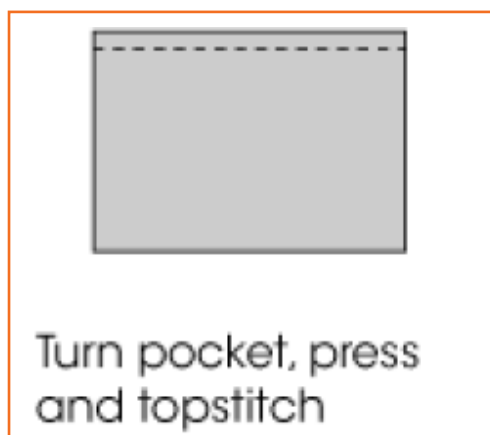

**STEP 3:** Turn the pocket right side out and push out the corners of the pocket with an item like a chopstick. (Don't use something too sharp or you will poke a hole through the fabric.) Press the pocket flat, folding in the raw edges of the opening. Top stitch along the fold, which will be the top of your pocket.



**STEP 4:** Place the pocket on the centre of the apron approximately 12" from the top. Stitch the sides and bottom of the pocket to the apron. (Placement of the pocket may vary).

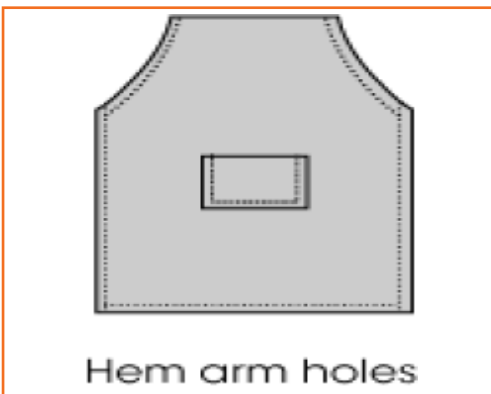
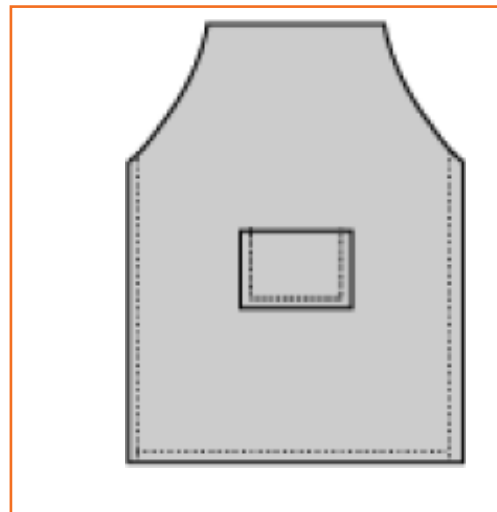

**STEP 6:** Using a double fold hem (folding fabric in 5/16", pressing, then folding 5/16" again and pressing for a 5/8" hem), pin and stitch the curved side of the apron.

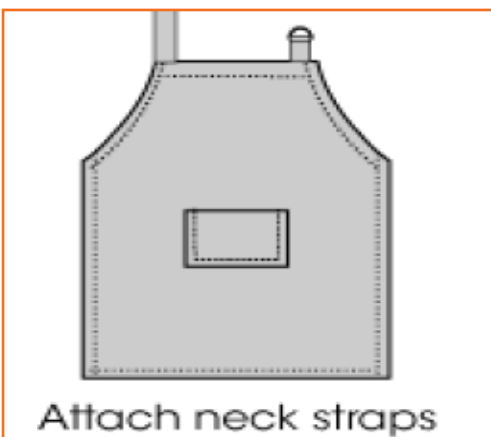
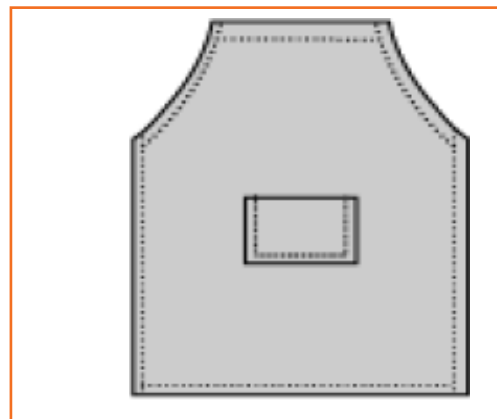

**STEP 8:** Using a double fold hem (folding fabric in 5/16", pressing, then folding 5/16" again and pressing for a 5/8" hem), pin and stitch the curved side of the apron.

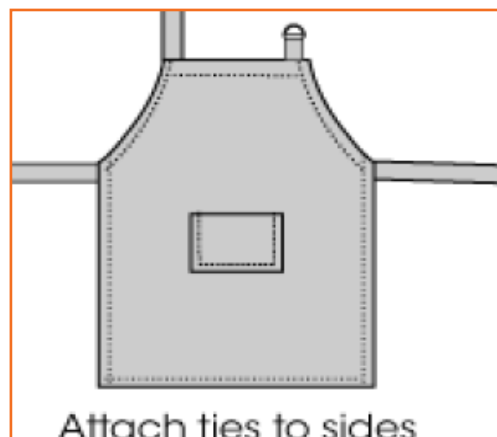

## Industry Visit

The purpose of visiting a tailor shop/boutique is to get hands on knowledge about various processes involved in the work of a tailor. During the visit you have to interact with Tailors and owner of the shop to understand how work is done in a tailor shop/boutique. Make sure that you keep a notebook handy and note down any important points that come up during your interaction at the tailor shop/boutique. When you go to an tailor shop/boutique, you should:

- Recognize the different types of sewing machine and understand the different parts of a sewing machine.
- Analyse how a tailor threads a sewing machine.
- Understand the different types of hand sewing methods.
- Recognize the different sewing machine problems.
- Understand the different sewing methods.
- Ask questions to Tailors/shop owners if you have any query.
- Observe the sequence of sewing of a basic apron.

## UNIT 3.2: Stitching

### Unit Objectives

At the end of this unit, participants will be able to:

1. Recognize the different parts of a trouser and a shirt.
2. Stitch trouser and shirt.

### 3.2.1 Trouser Stitching

Parts of a trouser

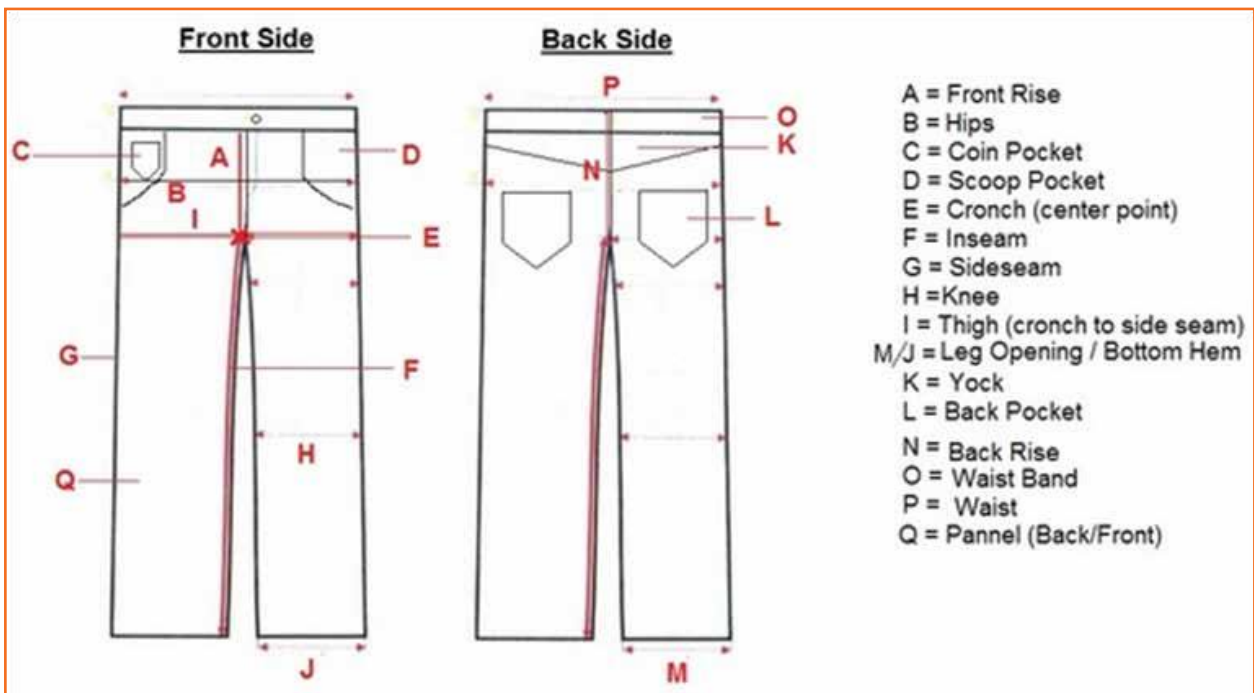
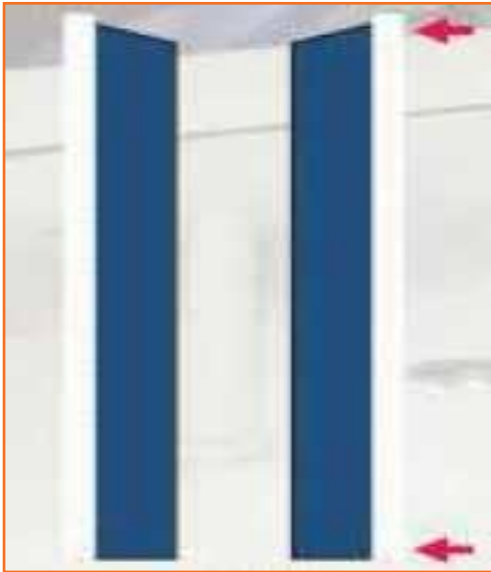
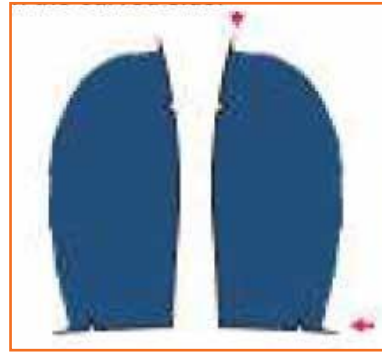

Fig 3.2.1: Parts of a trouser

### 3.2.1.1 Preparation of Pocket Bag (front)



**Step 1:** Take both the upper facing pieces and put over lock stitch on the longer straight sides. Make sure the face side of the pieces is on top.



**Step 2:** Take both the lower facing pieces and put over lock stitch on the curved sides. Again, make sure that the face side of the pieces are on the top.

- Note the notch marks on the lower facing pieces.
- Note that the overlock stitch is on the curved side.



**Step 3:** Take both of the pocket bag pieces and both upper facing pieces. Keep the upper facing piece over the pocket bag in such a way that the over lock part is facing inside and the stitch is facing upwards.

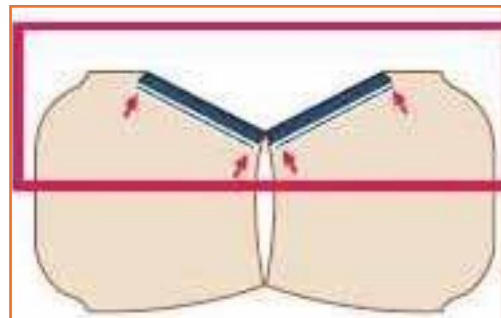

**Step 4:** Put lockstitch at the edge of the overlock stitch.



**Step 5:** Take both the lower facing pieces and keep them over the other side of the pocket bag.



**Step 6:** Put the lock stitch at the edge of the overlock curved stitch.



### 3.2.1.2 Pocket Attaching (front)



**Step 1:** Take the two front pieces and keep them on the sewing Fig with the face side up.

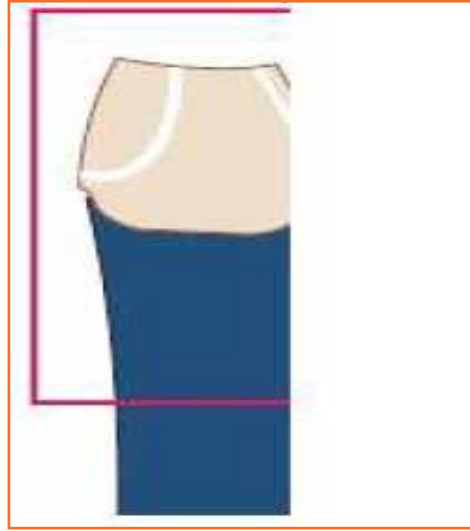

**Step 2:** Take the pocket bag and place it over the left front piece aligning with the mouth of the pocket.

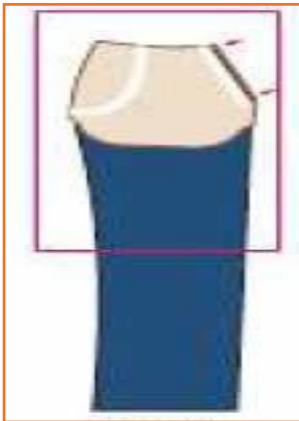

**Step 3:** Put 6 mm stitch taking  $\frac{1}{4}$  line on throat plate as guide, starting from the top to bottom.



**Step 4:** Turn the piece and put 4 mm stitch at the mouth of the pocket.



**Step 5:** Match the lower facing and upper facing at the notch marks.



**Step 6:** Put 2 mm stitch starting from the waistline to the outer side of the left front piece.



**Step 7:** Put 5 thread over lock stitches on the curved portion of the pocket bag.

**Step 8:** Take the other pocket bag and place it over the right front piece aligning with the pocket bag (face to face).

**Step 9:** Repeat steps 3-7 for the right hand side pocket.

### 3.2.1.3 Pocket Attaching (Back)

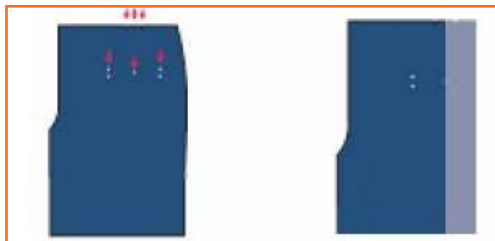

**Step 1:** Take a note of the notch marks and the pocket marking on the back piece.

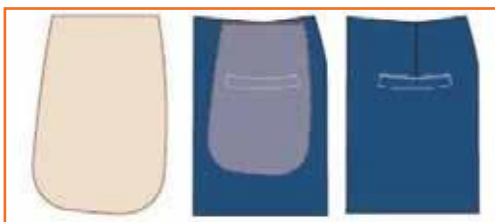

**Step 3:** Take one of the back pocket bags. Place it below the back piece in such a way that the top end of the back piece and the pocket bag are perfectly aligned. Make sure that pocket bag is aligned centrally to the dart.



**Step 2:** Fold the fabric at the center notch mark and make a dart by starting to stitch on the notch mark till the centre marking.

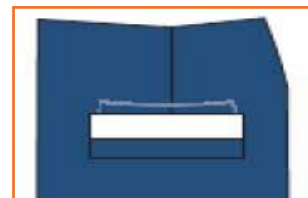

**Step 4:** Take one of the fused bone pieces and place it over the pocket markings in such a way that the top marks are visible and the bottom marks are covered by the bone pieces and are at equal distance from both sides.

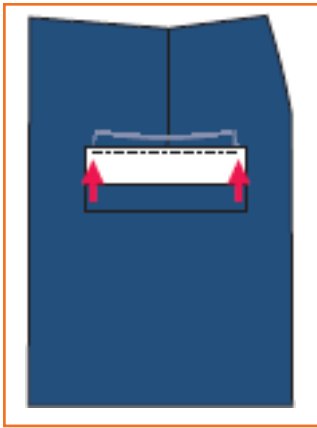

**Step 5:** Now put a 6 mm stitch starting from back rise side towards the side seam side. The first stitch should be at the notch mark side. Put back tack, both at the beginning and end of the stitch.

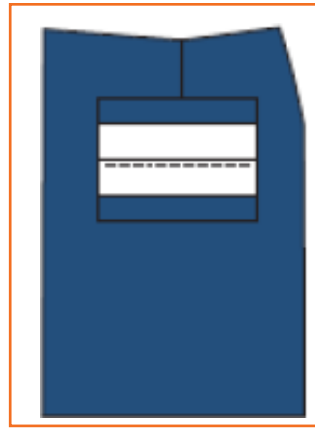

**Step 6:** Take the second fused bone piece and place it next to the stitched bone piece on the waist side.

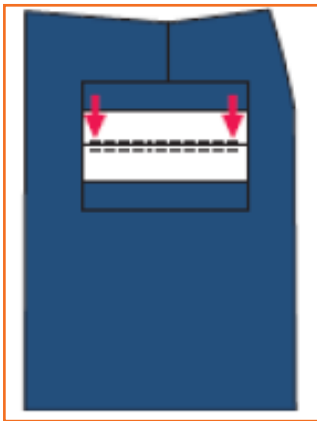

**Step 7:** Put 6 mm stitch starting from the side-seam side towards the back rise side.

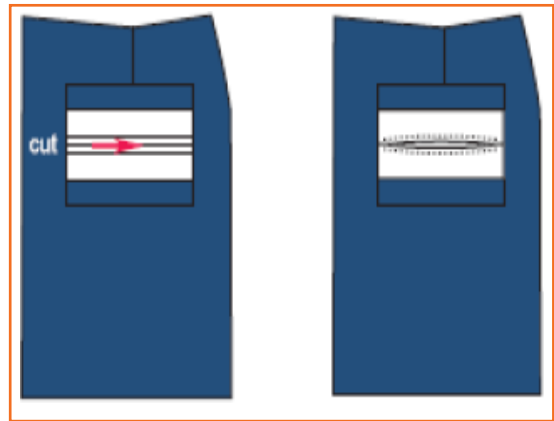

**Step 8:** Cut the fabric between the two bones leaving 10–12 mm on both sides.

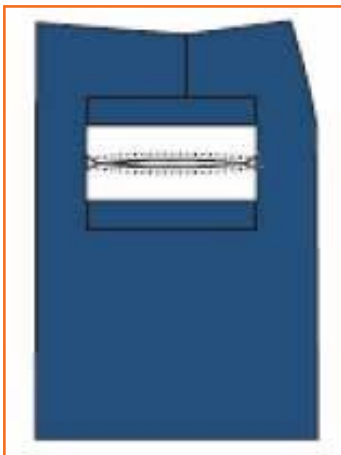

**Step 9:** Put 6 mm stitch starting from the side-seam side towards the back rise side.

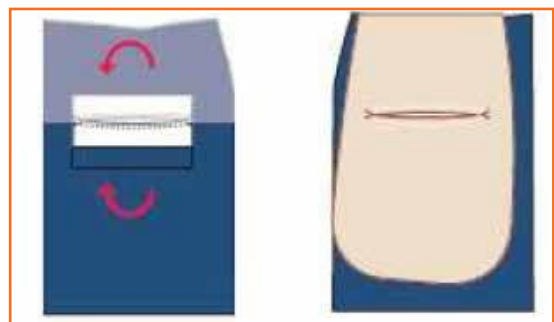

**Step 10:** Cut the fabric between the two bones leaving 10–12 mm on both sides.



**Step 11:** Put a stitch on the edge of the folded portion next to the stitched portion.

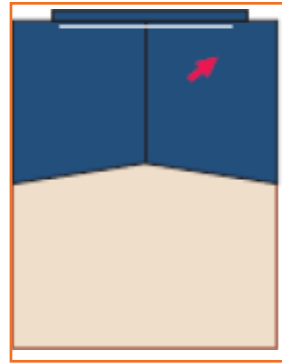

**Step 12:** Repeat steps 10 and 11 for the other bone.

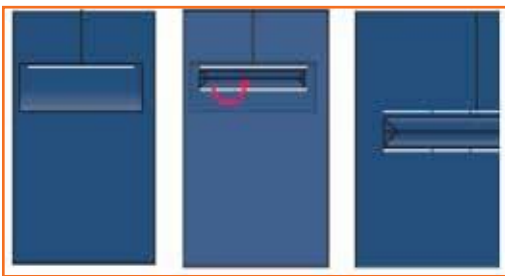

**Step 13:** Push the balance fabric inside.

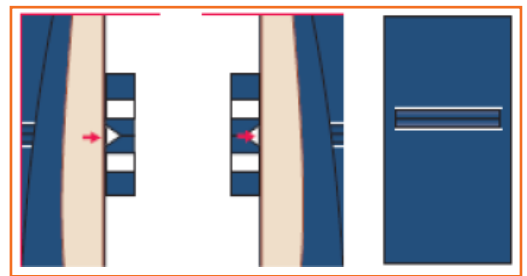

**Step 14:** Put a stitch at the end of the cut portion.

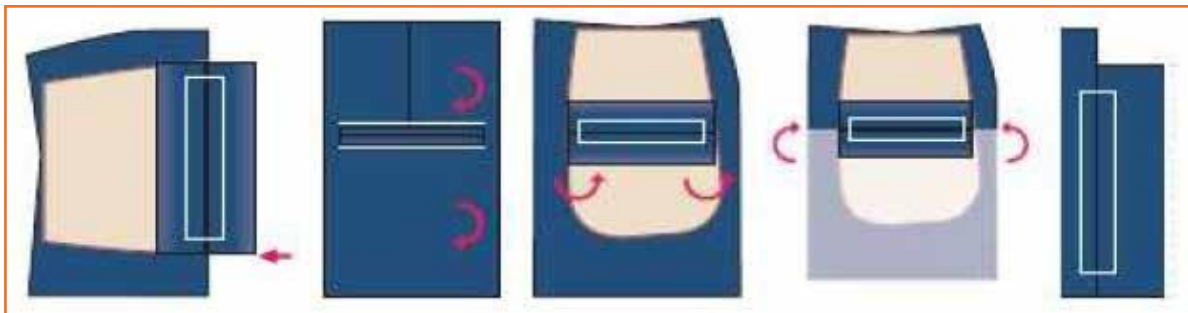

**Step 15:** Put overlock stitch at the loose end of the bottom bone piece.

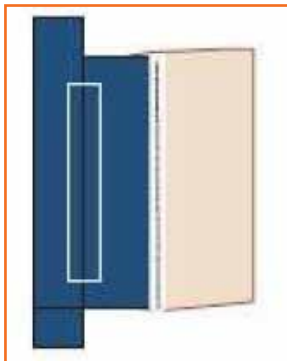

**Step 16:** Attach bone piece with the pocket bag using lockstitch.

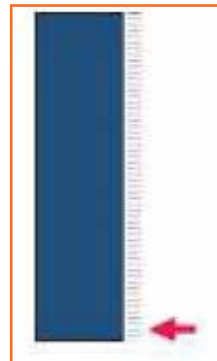

**Step 17:** Put over lock stitch on the back pocket facing.

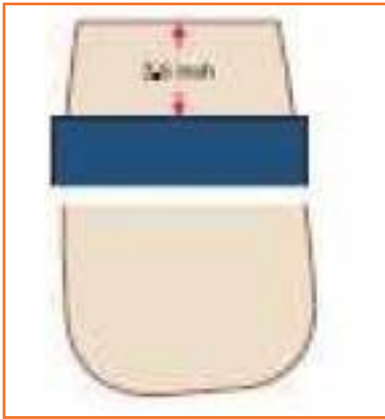

**Step 18:** Take the other piece of the pocket bag. Place the back pocket facing on top of the pocket bag at a distance of 2½ inches from top of the pocket bag.

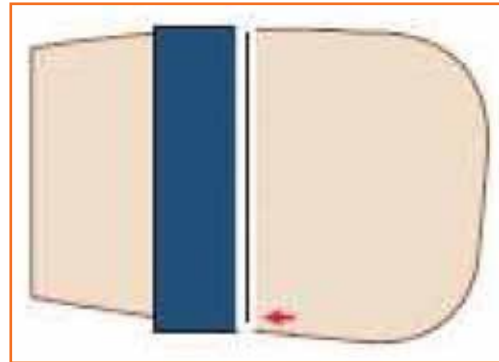

**Step 19:** Put a lock stitch over the over lock portion.

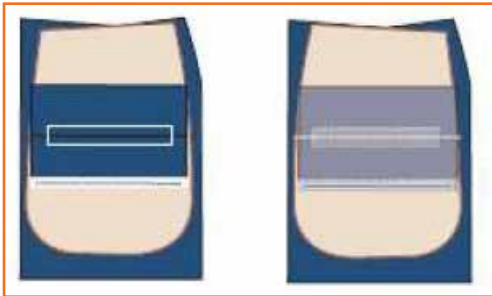

**Step 20:** Take the first pocket bag, which is already sewn to the back piece. Place the other pocket bag over it. Both the bags should match perfectly.

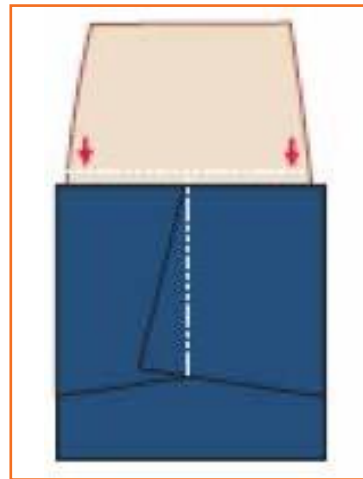

**Step 21:** Now put a stitch at the inner side to join the two pocket bags together.

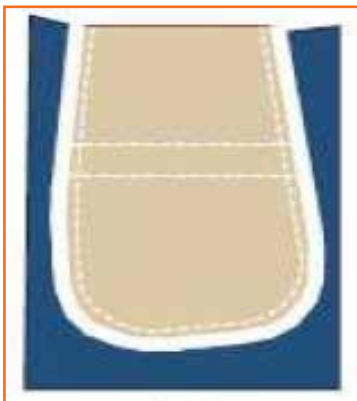

**Step 22:** Put 5-thread over lock stitches starting from right (back rise side) to the left side.

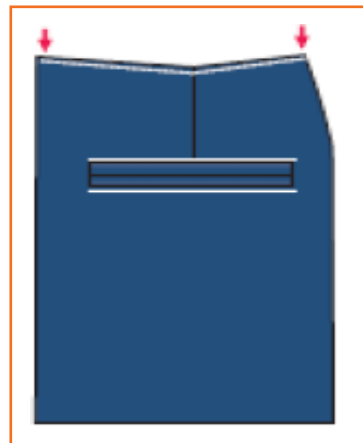

**Step 23:** Put 3 mm lock stitch at the waistline, starting from the left towards the right, to stitch the loose top end of the pocket bag with the fabric.

### 3.2.1.4 Fly Making and Attaching



**Step 1:** Take the fused J-fly piece and put over lock stitch on the face side of the fabric starting from bottom of the curved side till the top.

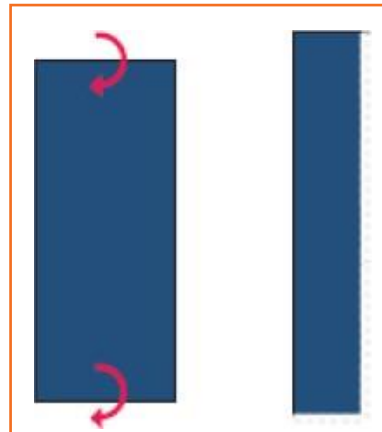

**Step 2:** Take the fly supportive part. Fold it into two equal parts and put over lock stitch on the long open side and one on the short open sides.

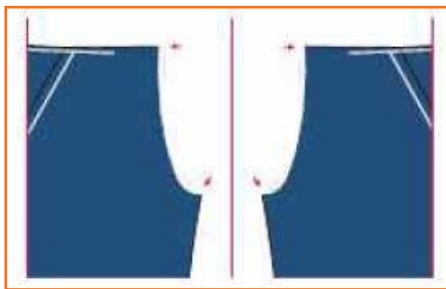

**Step 3:** Take the fused J-fly piece and put over lock stitch on the face side of the fabric starting from bottom of the curved side till the top.



**Step 4:** Take the left front piece and place the J-fl y piece over the left front piece. Align the straight end of the J-fl y with the front rise along with the backside of the J-fl y facing up.



**Step 5:** Put a 6 mm lock stitch starting from the bottom to the top (waist line).



**Step 6:** Turn the J-fl y piece and put an edge stitch on top of the fly from bottom to top. Make sure that the raw edges are facing towards the fly.



### 3.2.1.5 Zipper Attaching



**Step 1:** Take the zipper, open it and bring the slider down.



**Step 2:** Place the zipper with slider facing down over the fly piece at 8 mm from the straight edge at the top and 6 mm at the bottom. Align the bottom edge of the zipper with the curved portion of the fly piece.

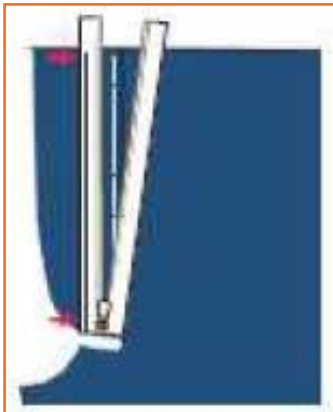

**Step 3:** Put an edge stitch on the left side of the zipper from top to bottom.

**Step 4:** Close the zipper and turn the piece 180o clockwise.



**Step 5:** Now put a 4 mm stitch starting from bottom to top.



**Step 6:** Take the fly supportive part. Place the zipper with slider facing up on the fly supportive part. Properly align the zipper end and the over lock side of the fly supportive part.

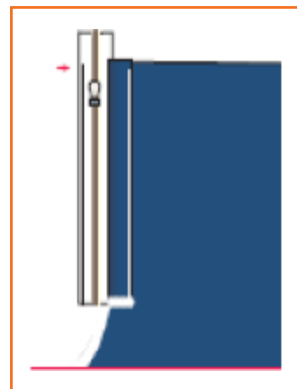

**Step 7:** Turn the fabric and put edge stitch on the zipper starting from bottom to top.

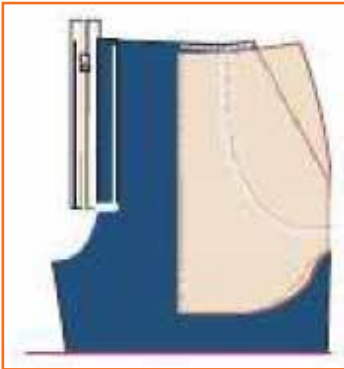

**Step 8:** Take the right front piece and place the front rise side over the zipper. Make sure that the waistlines of both the left and right front pieces match.



**Step 9:** Put 6 mm stitch starting from bottom to the top.



**Step 10:** Turn the stitched panels and bring the face side up.



**Step 11:** Leave a gap of 1 mm between the zipper teeth and the edge of the fabric and put top-stitch.



**Step 12:** Open the zipper.

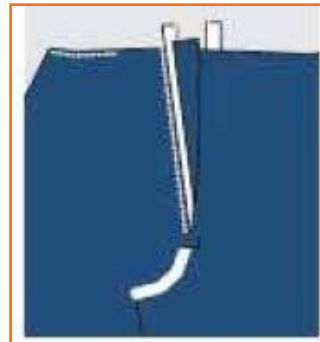

**Step 13:** Turn the left side front piece from the zipper side at the point of stitch.



**Step 14:** Place the ready pattern of J-fly over the left front piece on the front rise side.



**Step 15:** Put lock stitch along the ready pattern starting from top to the bottom.

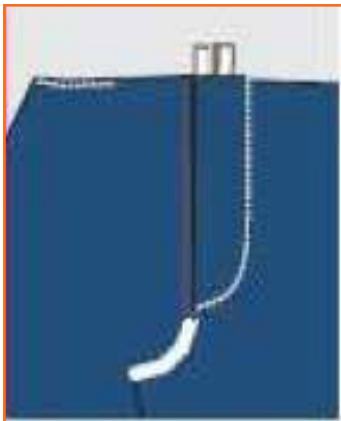

**Step 16:** Close the zipper and complete the J-stitch along the J-pattern.



**Step 17:** Put a top-stitch on the edge of the finished J-piece starting from bottom to top.

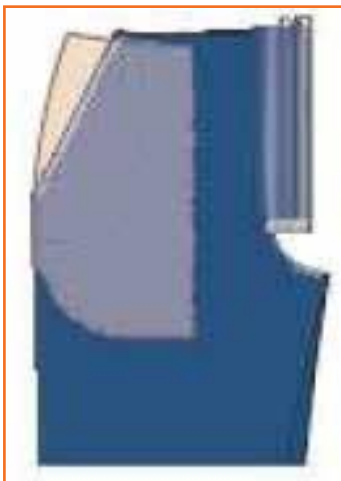

**Step 18:** Reverse the fabric and put 6 mm stitch on the curved portion of the front rise.



**Step 19:** Turn the piece so that the front side of the fabric is facing up. Put an edge stitch on front rise starting from bottom till the end of J-stitch.

### 3.2.1.6 Back Rise Attaching



**Step 1:** Take both the left and right back pieces. Match them face-to-face.



**Step 2:** Put 1 cm stitch at the back rise starting from top to bottom with back tack at both the top and bottom.



**Step 3:** Now put overlock stitches at the back rise starting from top to bottom.

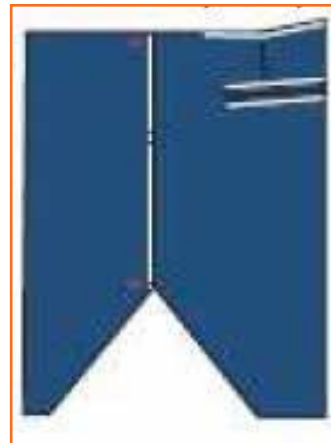

**Step 4:** Turn the raw edges towards the left side and put top-stitch at the edge of the back rise.

### 3.2.1.7 Front and Back Piece Attaching



**Step 1:** Place front and back pieces in such a way that the face sides of both pieces face each other.



**Step 2:** Put 1 cm stitch throughout the right side starting from top to bottom.



**Step 3:** Turn the raw edges towards the back. Put top stitches at the edge starting from top to bottom for the right side and bottom to top for the left side.



**Step 4:** Align the back and front rise seams and the open sides of the front and back.



**Step 5:** Put 5-thread over lock stitches starting from bottom to finish at other bottom side.

### 3.2.1.8 Belt Loop Making

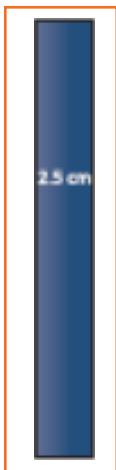

**Step 1:** Take a long strap, 2.5 mm wide, of the fabric used in body.



**Step 2:** Turn the raw edges towards the left side and put top-stitch at the edge of the back rise.

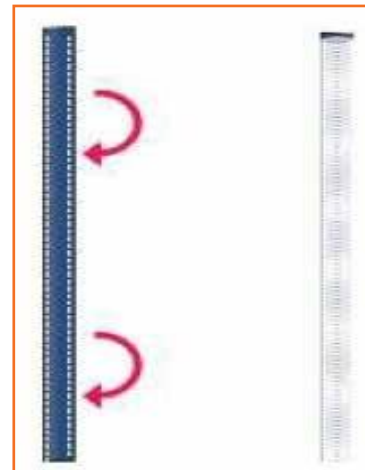

**Step 3:** Start sewing and feeding the fabric properly.

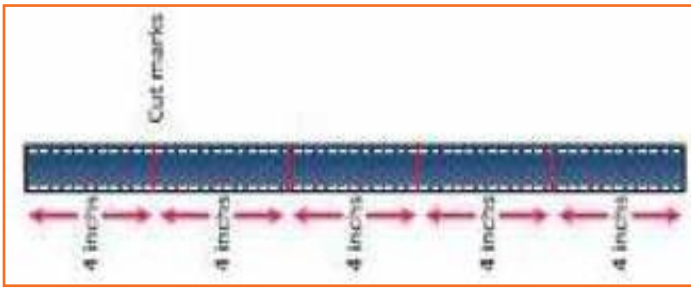

**Step 4:** Put the marking on the strap for the required length.



**Step 5:** Cut the strap of desired length.

### 3.2.1.9 Belt Loop Attaching

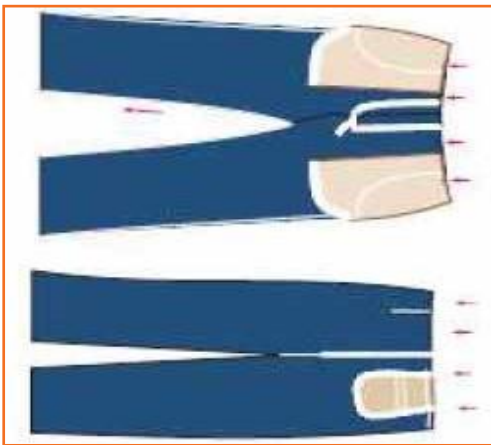

**Step 1:** Mark the positions on the waistline where the loops are to be attached.



**Step 2:** Place the belt piece, with the folded side up on the backside of the right front. Belt band should be extended by  $\frac{1}{2}$  inch.

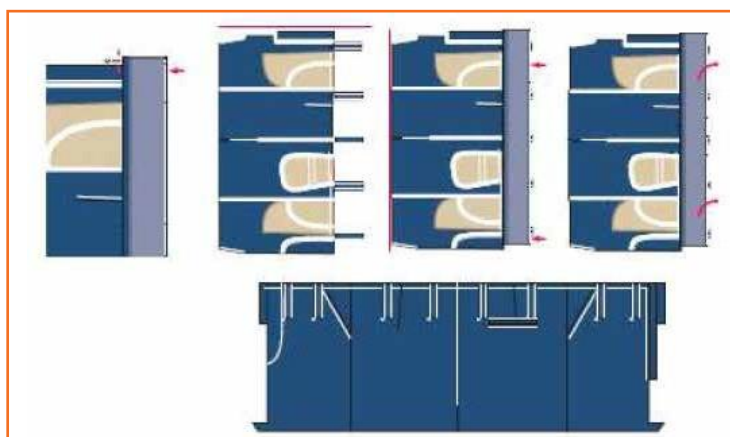

**Step 3:**

- Put a lock stitch adjacent to the folded part of the belt piece.
- Place the loop with the side facing the fabric and continue to stitch till the end by placing other loops at required positions.



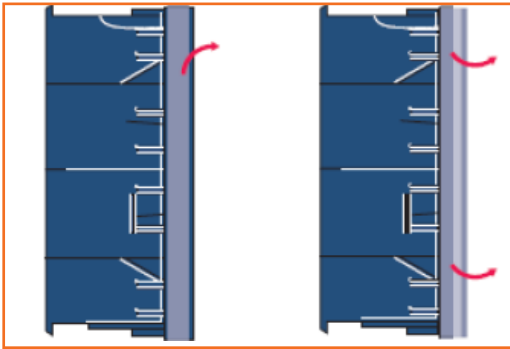

**Step 4:** Turn the belt piece in such a way that the fused side is up.

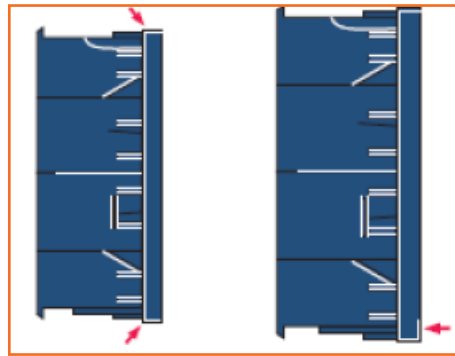

**Step 5:**

- Stitch the open vertical end on both sides starting with back tack.
- Now again turn the belt piece so that the face side is facing up.

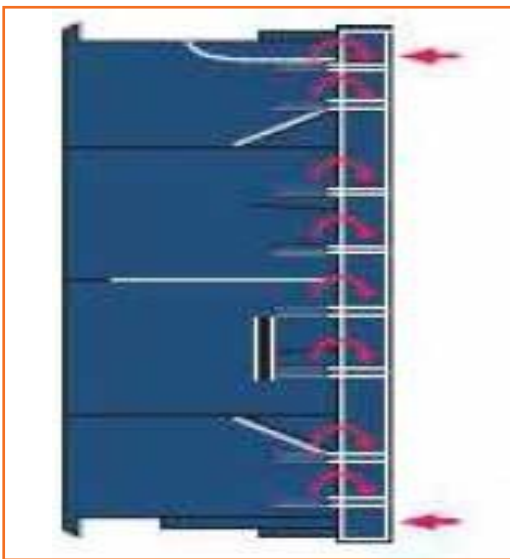

**Step 6:** Now put edge stitches throughout the length of the belt on the bottom side.

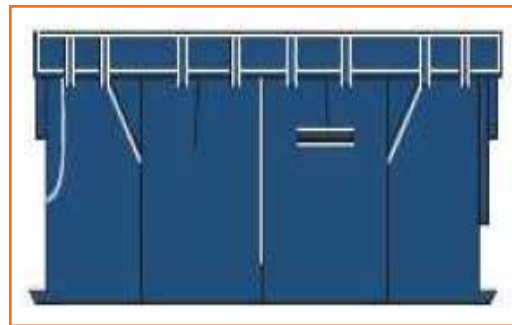

**Step 7:** Finally put edge stitches throughout the top side of the belt and stitch the loops at appropriate positions.

### 3.2.1.10 Bottom Hemming

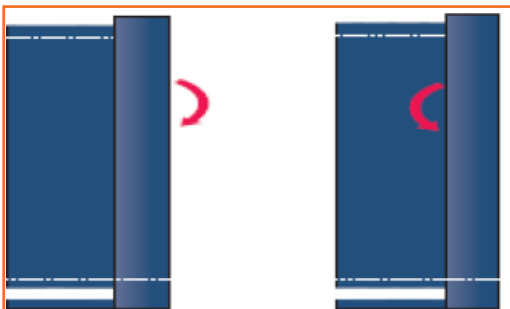

**Step 1:** Fold the fabric as per the design requirement.

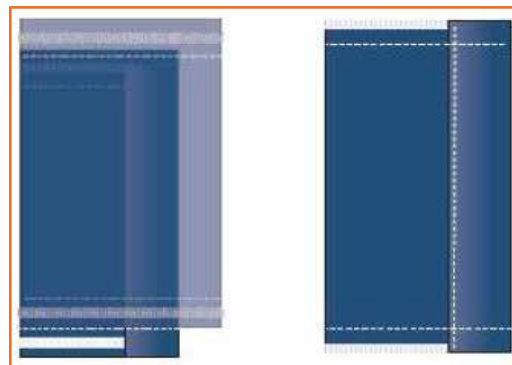

**Step 2:** Start putting the edge stitch from the inseam and finish at inseam. Repeat steps 1 and 2 for the other leg.

### 3.2.1.11 Bottom Hemming Using Folder



- Step 1:** Fold the bottom of right trouser leg 1 cm inside. Again fold the fabric to the required width and put 2 or 3 stitches.
- Step 2:** Place the attachment in such a way that the folded portion is fitted into the groove of the folder and then start stitching. Feed the fabric properly.
- Step 3:** Repeat steps 1 and 2 for the other leg.

### 3.2.1.12 Button Holing

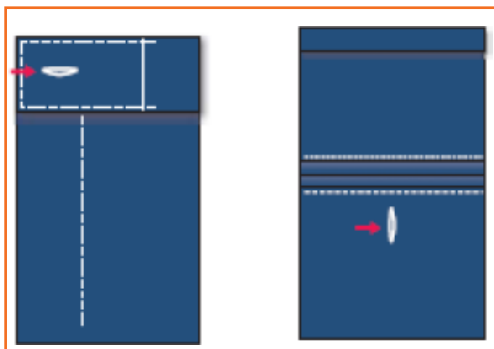

- Step 1:** Make the buttonhole on the left hand side belt as per design requirement. Make another buttonhole on the back pocket.

### 3.2.1.13 Button Attaching

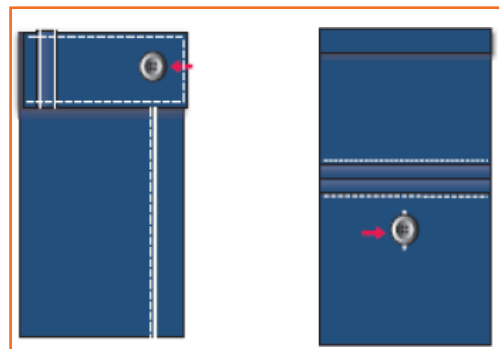

- Step 1:** Sew the button on the right hand side belt as per the design requirement and sew one button at the back pocket.

### 3.2.1.14 Bartacking

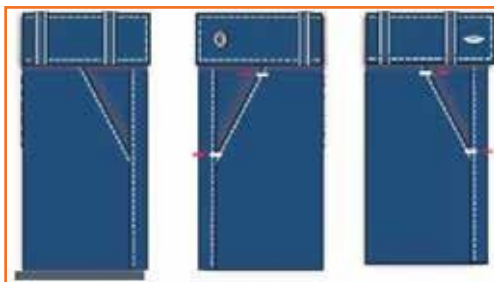

- Step 1:** Put bartack as per design requirement. Normally bartacks are put at both ends of left and right front pocket mouth and at the end of the front and back pocket joints.

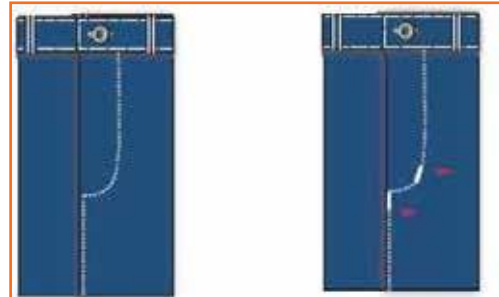

- Step 2:** Put the bartack at the end of the J-fly and at the curve of the J-fly.

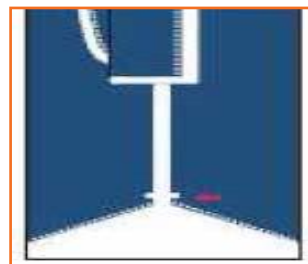

- Step 3:** Put the bartack at the joining of front and back rise.

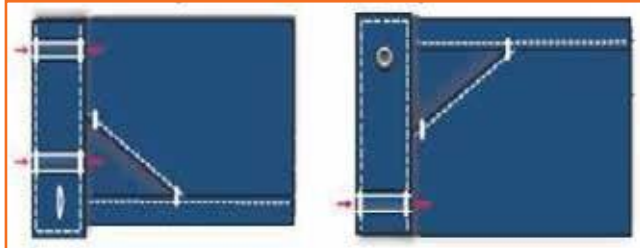

**Step 4:** Put the bartack at the top and bottom of each belt loop.

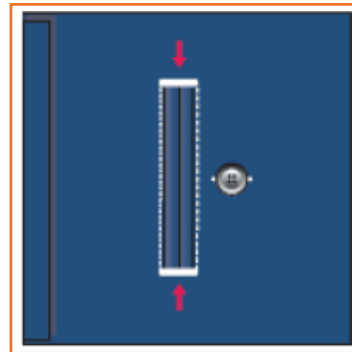

**Step 5:** Put the bartack at both ends of the back pocket.

### 3.2.2 A Traditional Shirt

#### Parts of a Shirt

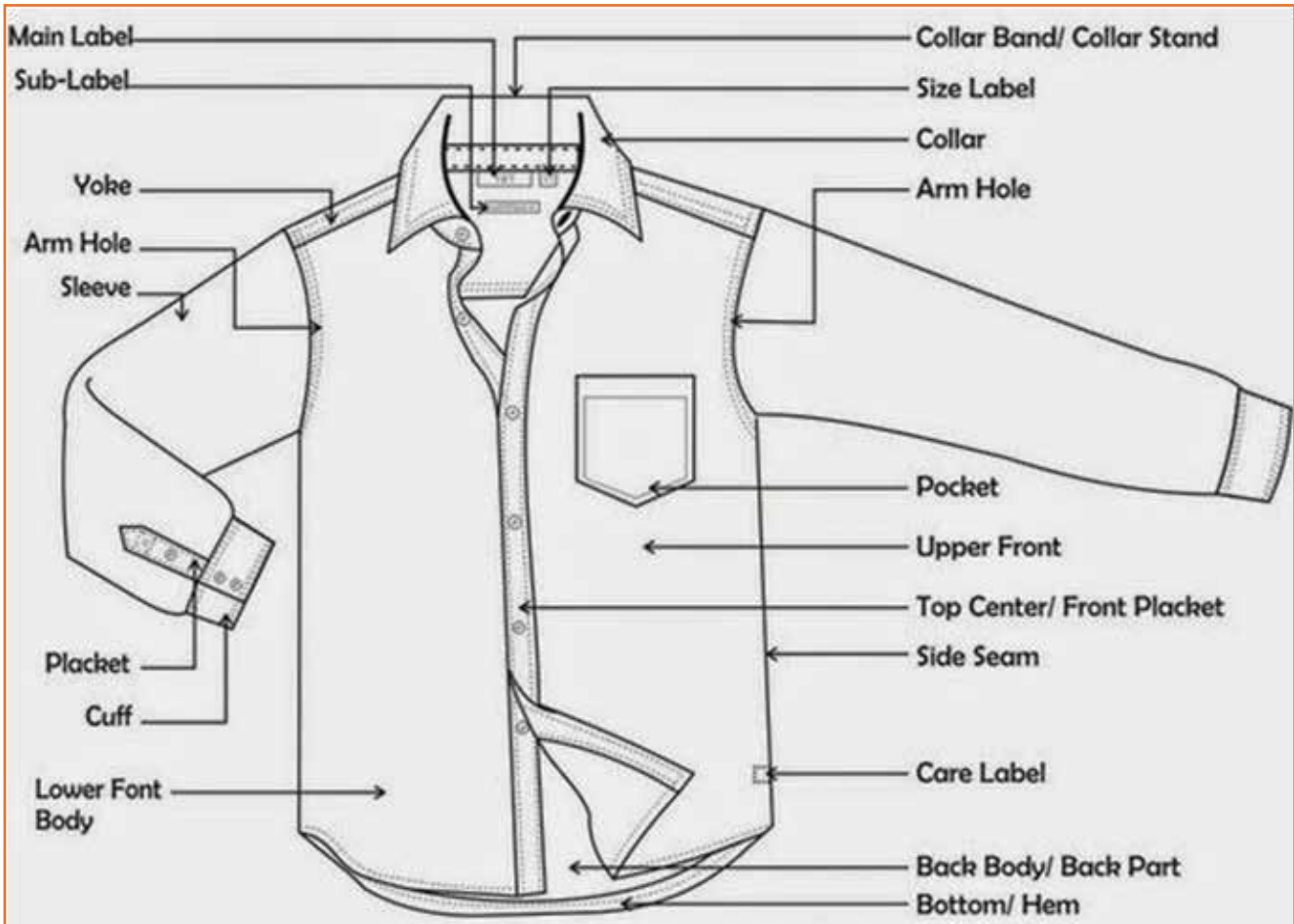
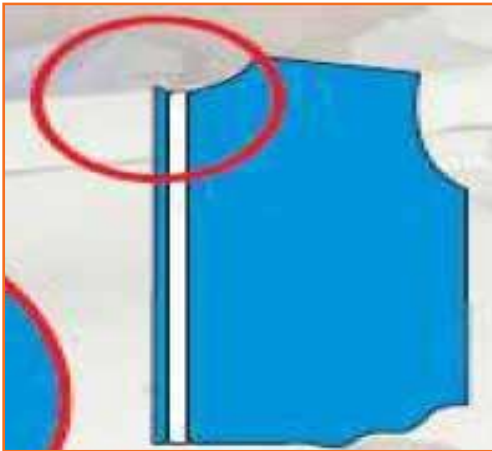
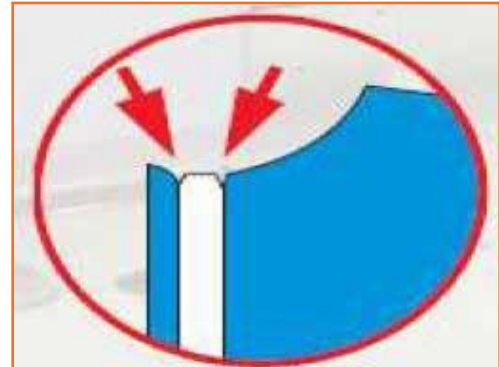

Fig 3.2.2: Parts of a Traditional Shirt

### 3.2.2.1 Left Hand Side Placket



**Step 1:** Take the fused left hand side placket.



**Step 2:** Locate the two notch marks. There is one at 2.3 cm and the other at 5.5 cm from the edge.

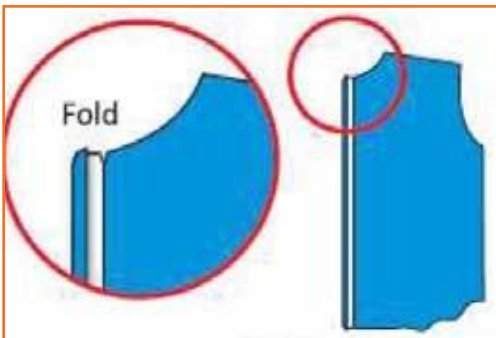

**Step 3:** Now, fold the fabric 2.3 cm till the first notch mark and press the folded part with an iron.

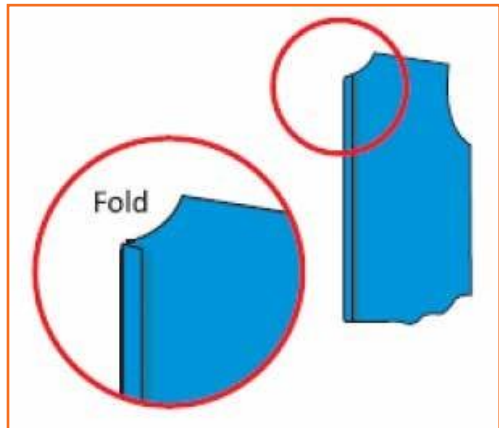

**Step 4:** Now, fold the fabric 4 cm to the second notch mark. The placket should be 4 cm wide.



**Step 5:** Now, crease the folded part again with an iron.

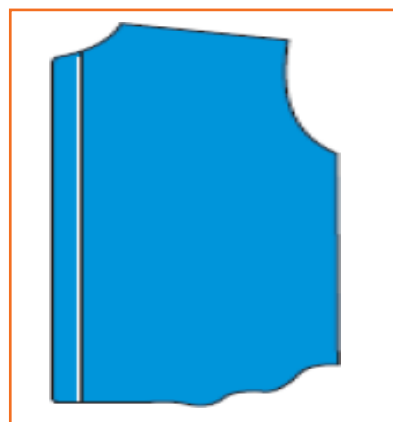

**Step 6:** Start from the bottom and stitch the inner side of the placket using edge stitch.



**Step 7:** Again from the bottom, stitch the outer side of the placket using edge stitch.

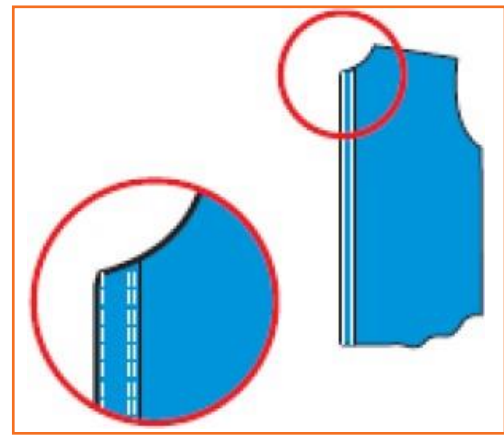

**Step 8:** Identify the reference mark on the throat plate and put a 4 mm stitch on the outer side of the placket from the bottom.

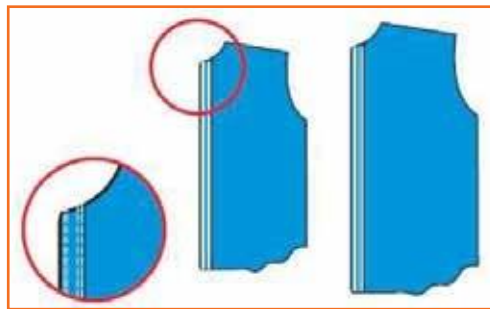

**Step 9:** Put a 4 mm stitch on the inner side of the placket from the top.

### 3.2.2.2 Right Hand Side Placket

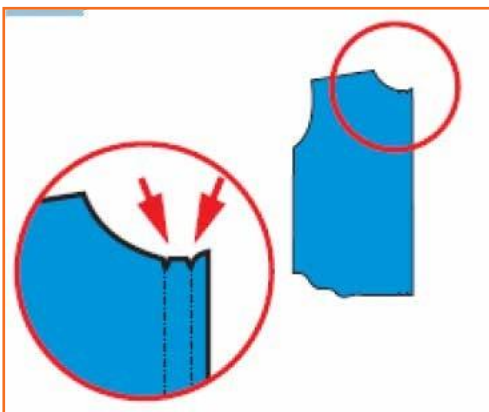

**Step 1:** Identify the notch marks on the back side of the fabric.

**Step 2:** Fold the fabric 1cm towards the notch mark or the neck, on the back of the fabric.

**Step 3:** Crease folded part.

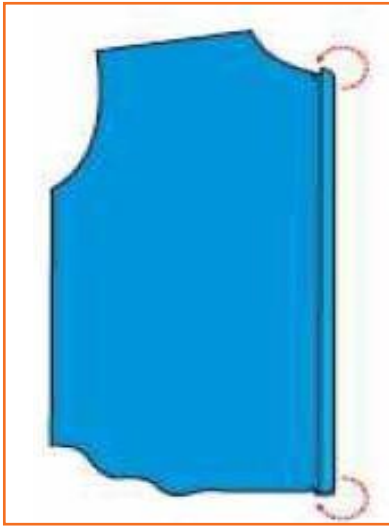

**Step 4:** Now, fold the fabric 2.5 cm till the second notch mark.

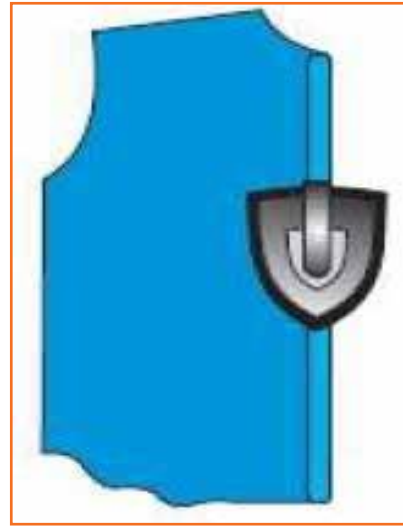

**Step 5:** Crease the fold with an iron again like in Step 3.

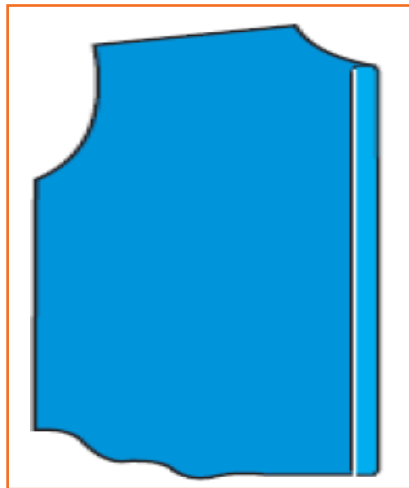

**Step 6:** Start from the top and stitch the inner side of the placket using an edge stitch.

### 3.2.2.3 Pocket Making and Stitching



**Step 1:** Take the fused pocket piece.

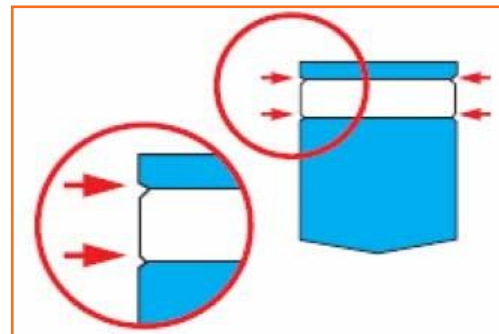

**Step 2:** Locate the notch marks.



**Step 3:** Now, fold the top part of the fabric 1cm till the first notch mark and press the folded part with an iron.

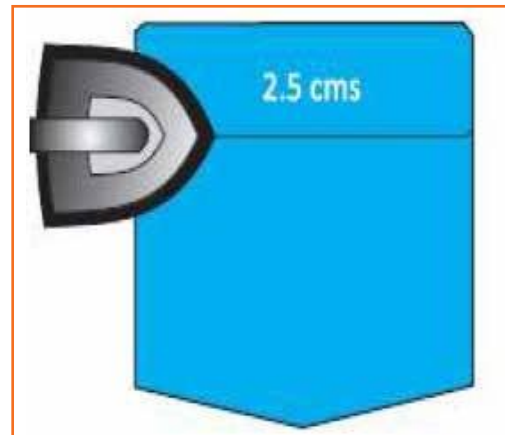

**Step 4:**

- Now, fold the fabric 2.5 cm to the second notch mark.
- Now, crease the folded part again with an iron.



**Step 5:** Stitch the inner side of the pocket mouth using edge stitch.

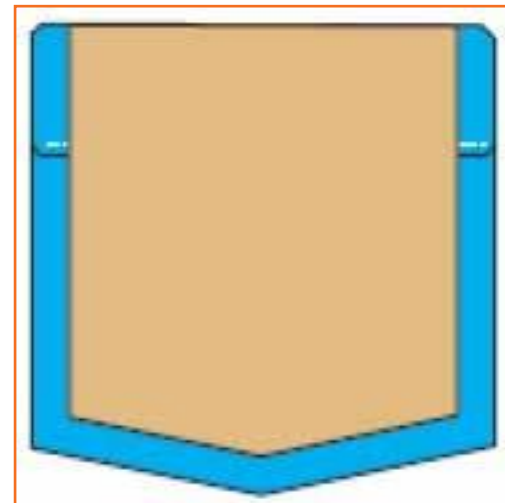

**Step 6:** Take the ready pattern given and place it over the pocket.



**Step 7:** Now, fold the three sides 1 cm each and crease them as you fold.



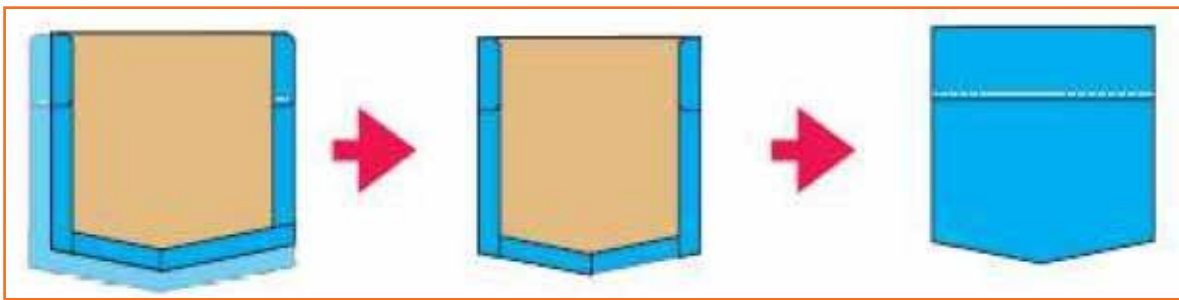

**Step 8:** The pocket is now ready to be attached.

### 3.2.2.4 Attaching the Pocket

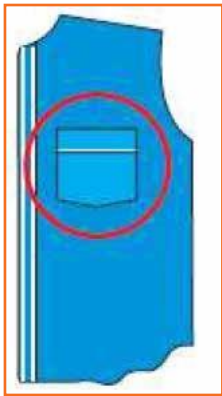

**Step 1:** Place the pocket piece on the left half of the shirt front.

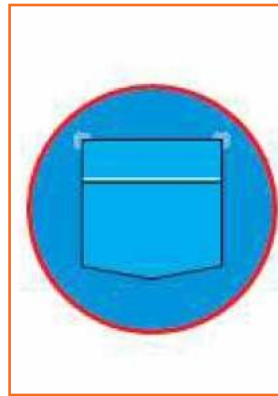

**Step 2:** Match the right side of the pocket with the markings on the front of the fabric.

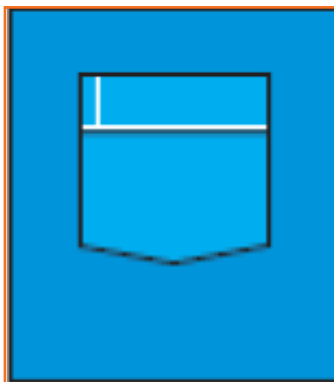

**Step 3:** Sew the pocket from the placket side. Put 4 stitches followed by a back tack.

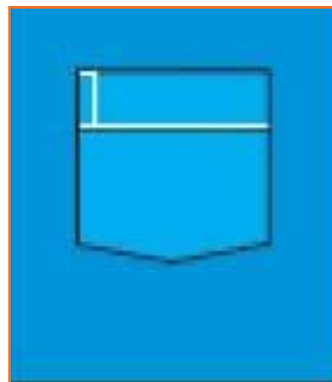

**Step 4:** Now, sew till the top using 4 mm stitch.

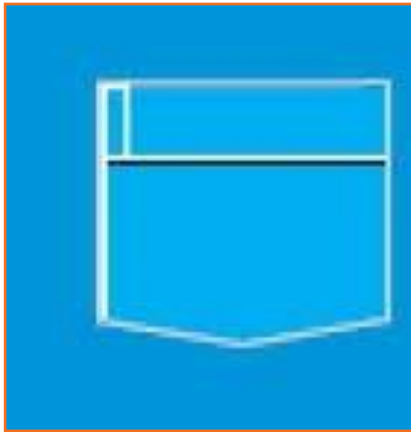

- Step 5:**
- Turn the fabric in a clockwise direction. Keep the needle in the fabric.
  - Stitch at the edge of the pocket till the end.

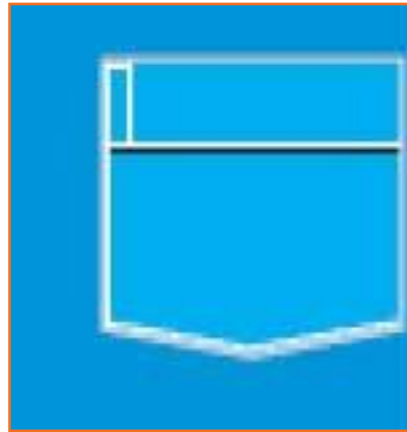

- Step 6:**
- Again, turn the fabric clockwise.
  - Put the stitch at the edge till the end.



- Step 7:**
- Again, turn the fabric clockwise. Stitch the edge of the bottom part of the pocket.
  - Step 10: Turn the fabric clockwise and stitch the edge of the other side of the pocket.

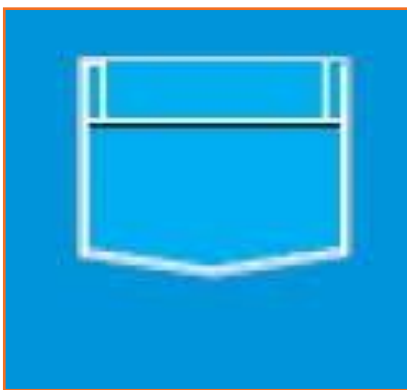

- Step 8:**
- Again, turn the fabric clockwise and stitch up to 4 mm.
  - Turn the fabric. Stitch up to the pocket mouth and put a back tack.

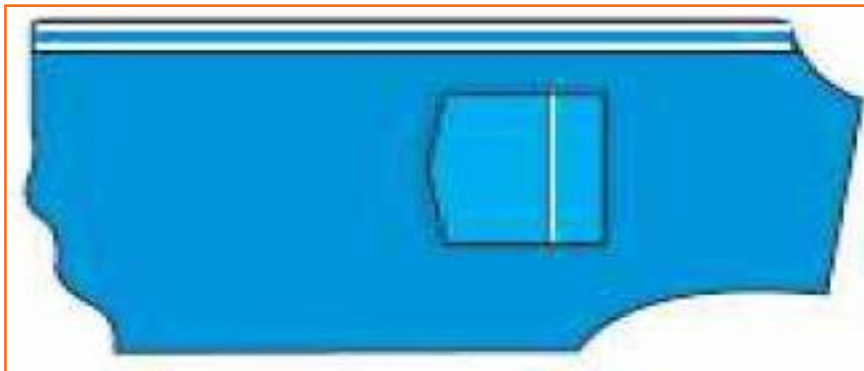

- Step 9:** Now, the pocket is fully attached.

### 3.2.2.5 Attaching Yoke

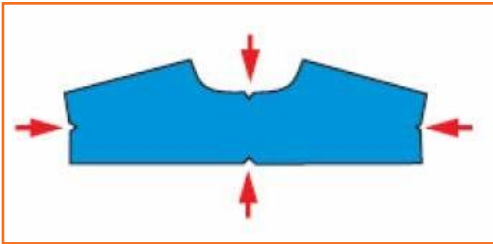

**Step 1:** First, check for the following notches:

- One notch at the center of the back piece of the shirt.
- 4 notches in the yoke piece:
  - » One at the center of the reverse side of the yoke piece.
  - » One at the center of the neckline.
  - » One at the center of the left armhole.
  - » One at the centre of the right armhole.

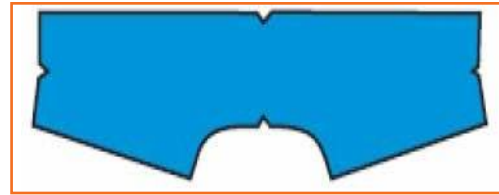

**Step 2:** Keep one piece of the yoke on the sewing Fig.



**Step 3:** Place the back piece of the shirt on top of the yoke in alignment with the two notches.

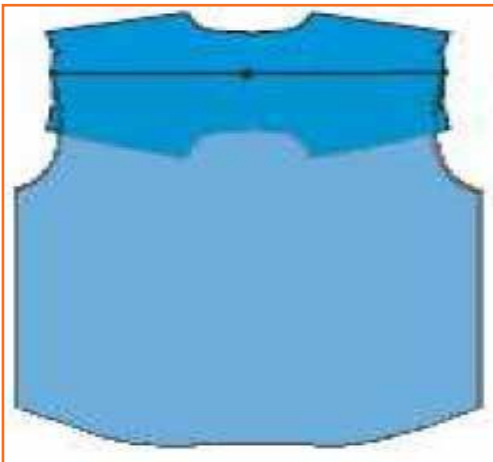

**Step 4:** The right side of the inner yoke piece should face the reverse side of the back piece of the shirt. Take the other yoke piece and place it on top of the back piece of the shirt and align with the notch.



**Step 5:** The alignment should be such that the right side of the outer yoke piece faces the right side of the back piece of the shirt.



**Step 6:** Put a stitch of 1cm on the edge of the 3 pieces—2 yoke pieces and the back piece of the shirt.



**Step 7:** Turn the yoke and crease it with your fingers.

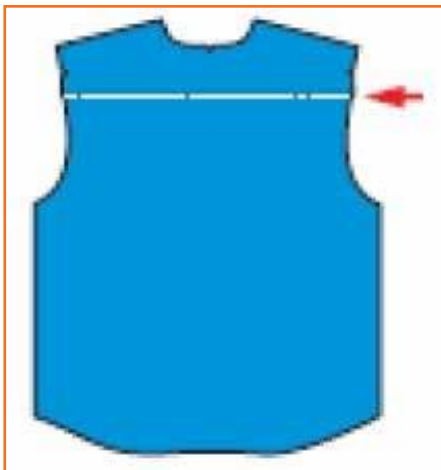

**Step 8:** Now, put a top-stitch at the edge first.

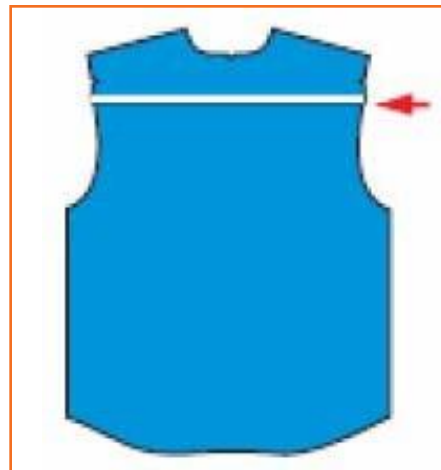

**Step 9:** Finally, put a 4 mm stitch from the edge.

### 3.2.2.6 Attaching Yoke to the Front



**Step 1:** Keep the front side of the back piece of the shirt on the top.

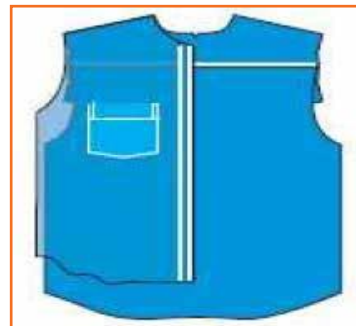

**Step 2:** The alignment should be such that the right side of the outer yoke piece faces the right side of the back piece of the shirt.



**Step 3:** The pieces are stitched at a distance of 1 cm from the edge leaving the bottom-most ply of the yoke.



**Step 4:**

- The right side of the front and the right side of the back piece of the shirt are placed together by matching the yoke. The placket should be towards the center.
- Repeat Step 3 for right side.

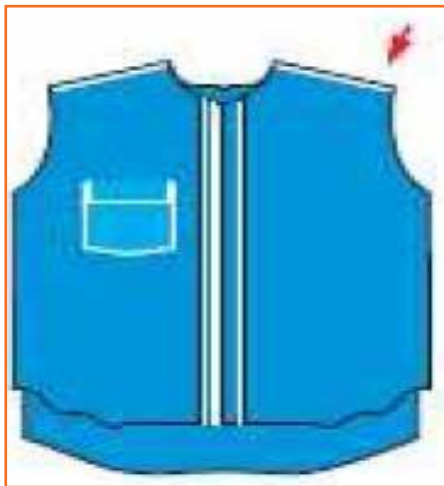

**Step 5:** Hold the edge of the yoke from the armhole side in one hand and the unstitched yoke piece in the other hand.



**Step 6:** Turn and match the un-stitched yoke piece to the stitched yoke piece.



**Step 7:** Roll the body fabrics and insert it between the two yoke pieces.



**Step 8:** Put a 1 cm stitch throughout.

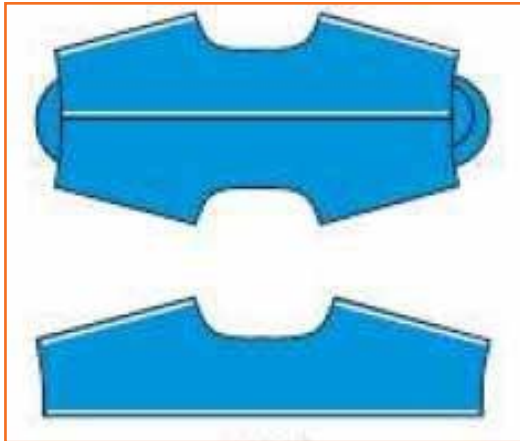

**Step 9:** Hold the front and the back pieces and stretch them.

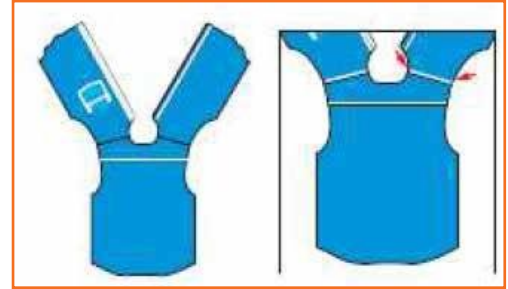

**Step 10:** Put a top-stitch at the edge on both sides.



**Step 11:** Finally, put a 4 mm stitch on both sides.

### 3.2.2.7 Upper Sleeve Placket Preparation

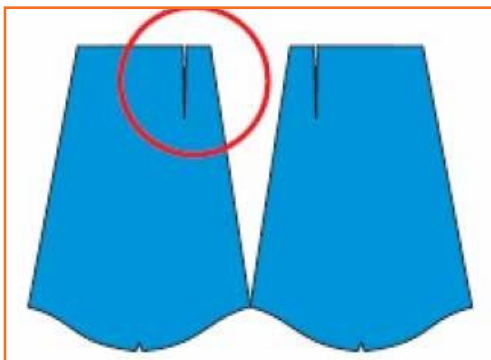

**Step 1:** Take the two sleeve pieces and identify the notch marks on the armhole side in each one of them.

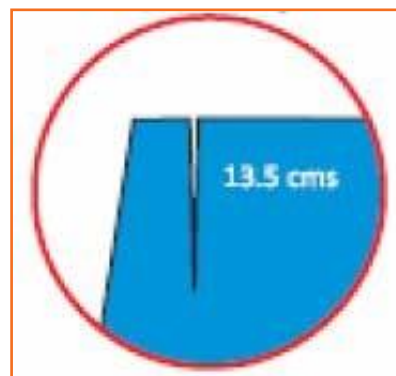

**Step 2:** Look at the reverse side of the sleeve and ensure that there is a cut of 13 cms or 5 inches at the bottom.



**Step 3:** Keep the two sleeve plackets with their straight sides facing each other.

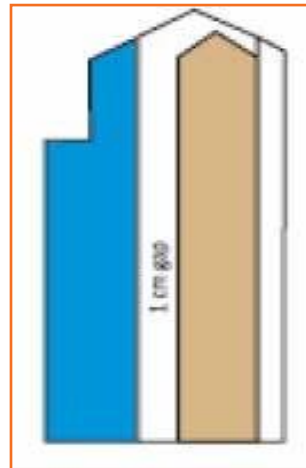

**Step 4:** Take the ready pattern. Leave a gap of 1 cm and place it over the longer side of the placket.

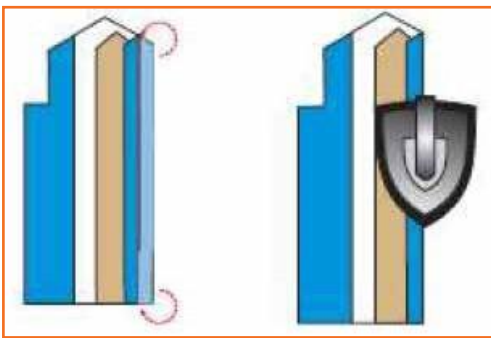

**Step 5:** Use the pattern and fold the longer side of the placket 1 cm and iron it.

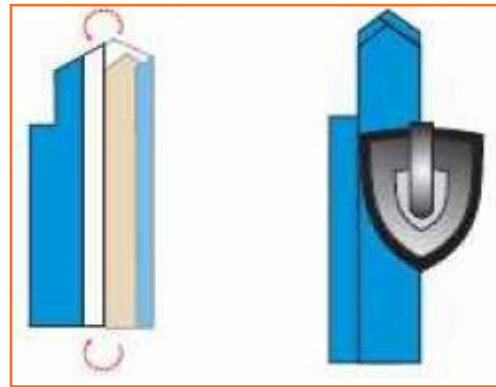

**Step 6:** Again, using the pattern, fold the longer side 3.5 cm and iron it.

**Step 7:** Use the pattern and fold the upper portion of the placket in a V-shape. Iron it well to form crease.

**Step 8:** Use the pattern and fold the upper portion of the placket in a V-shape. Iron it well to form crease.

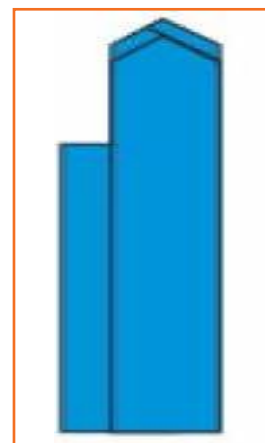



### 3.2.2.8 Lower Sleeve Placket Preparation

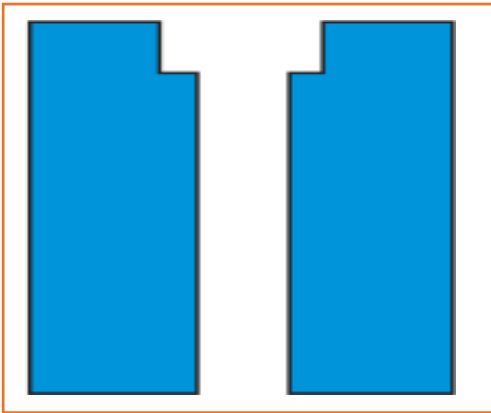

**Step 1:** Keep both the lower sleeve plackets on the Fig.

They are unfused and shorten in length than upper sleeve plackets.

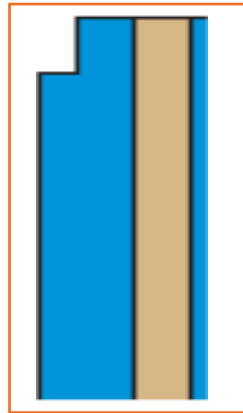

**Step 2:** Place the ready pattern on the placket.



**Step 3:** Use the pattern and fold 1 cm. Use the iron to crease it.

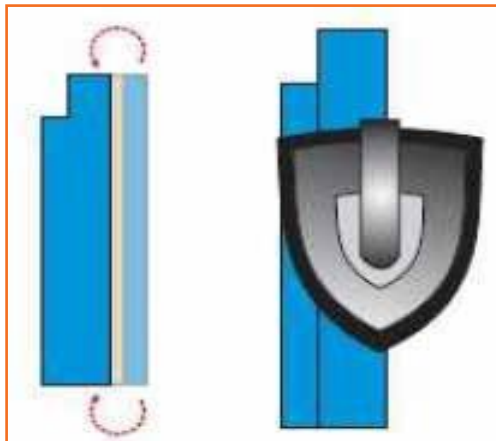

**Step 4:** Again, use the pattern and fold 2 cm. Use the iron to crease it.

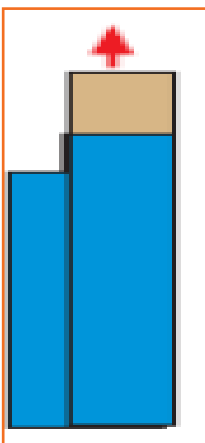

**Step 5:** Remove the ready pattern.

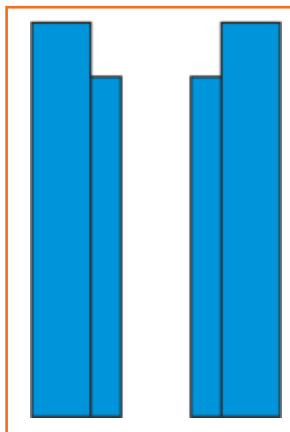

**Step 6:** Repeat Steps 2 to 5 for the other placket.

### 3.2.2.9 Attaching Plackets to the Sleeve

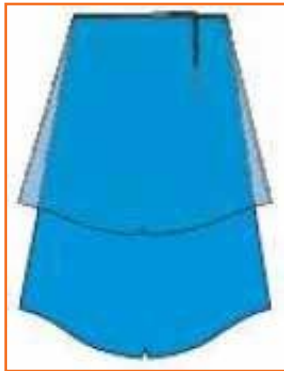

**Step 1:** Place the two sleeves on top of each other and align the cut sides.

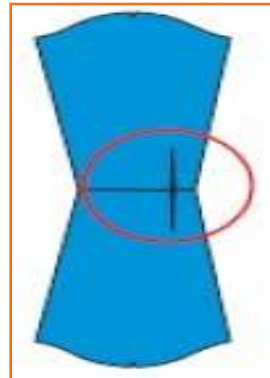

**Step 2:** Take the two upper sleeve plackets and place them on the longer cut side of the sleeves. Ensure that the folded side is on top.

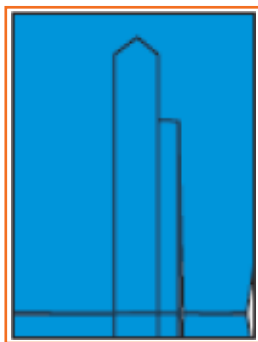

**Step 3:** Take a set of sleeve placket and sleeve. Align the edges of the sleeve placket with the longer cut part of the sleeve.

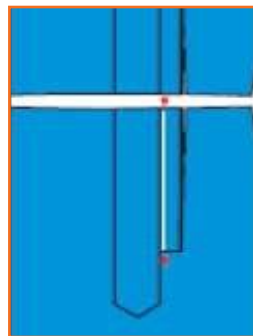

**Step 4:** Stitch the placket edge. Take the other set of sleeve and sleeve placket. Stitch the placket edge.

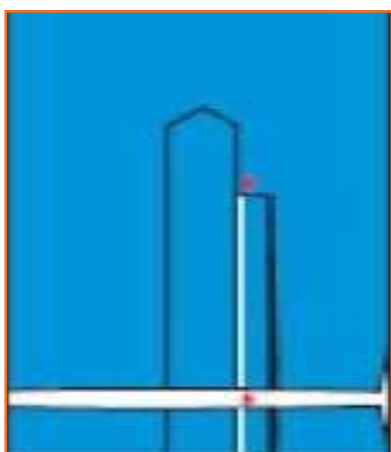

**Step 5:** Turn the fabric such that the cut part of it faces you.



**Step 6:** Now, place the lower placket on the shorter cut part of the fabric and stitch the edge along the length. Repeat Step 3 and Step 6 for the other set of sleeve plackets and sleeves.

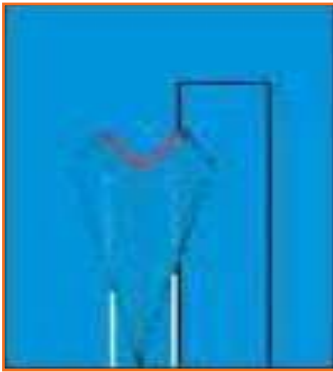

**Step 7:** Make two v-shape cuts on the top part of the placket-stitch.

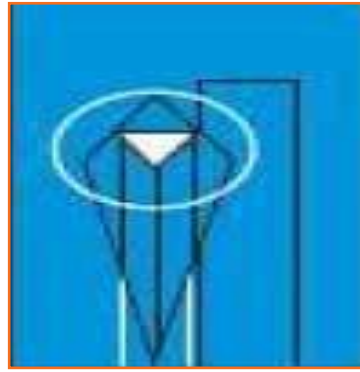

**Step 8:**

- Smoothen the lower placket and turn it to the reverse side.
- Stitch the edged side of the lower placket till the end.
- Turn the v-shaped cut to the upper side.

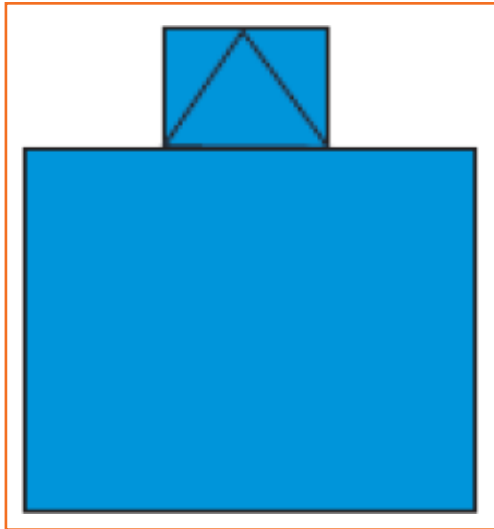

**Step 9:** Place the placket on top of the v-shaped cut.

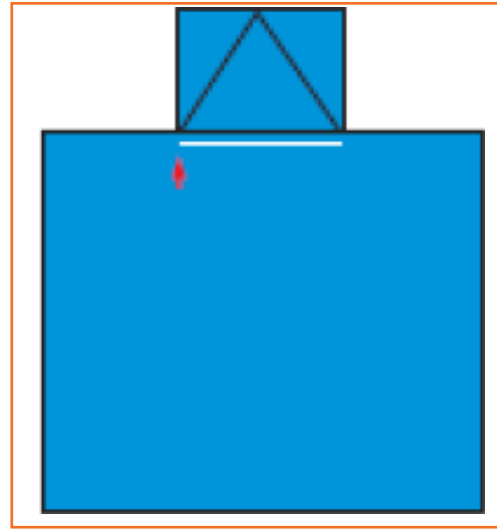

**Step 10:** Hold the placket and the cut, together and put a stitch at the bottom of the cut.

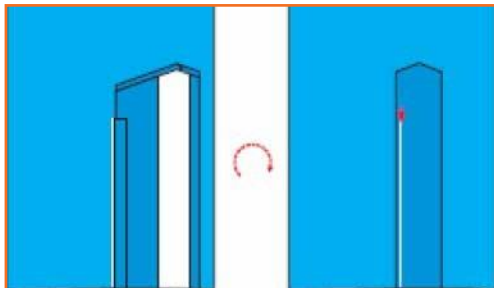

**Step 11:**

- Turn the upper placket over and put an edged stitch till the end.
- Turn the fabric clockwise. Align the upper and lower plackets.

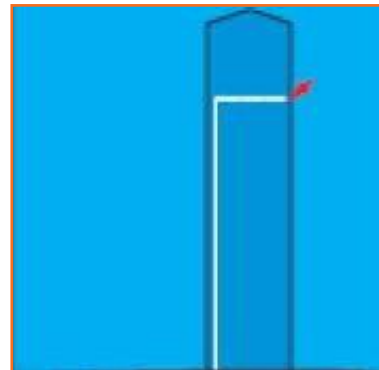

**Step 12:** Stitch till the end of the plackets.

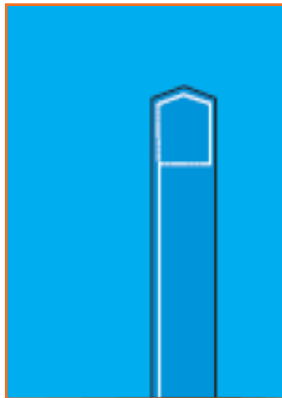

- Step 13:**
- Turn the fabric counter-clockwise. Put an edge stitch on all the edges of the box of the placket.
  - Repeat Step 9 to Steps 7-13 for the other sleeve plackets.

### 3.2.2.10 Attaching the Sleeve

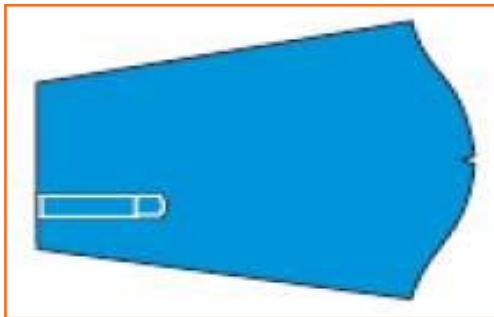

- Step 1:** Take the sleeve piece. Ensure the armhole faces you. Also, the longer cut edge should be on the right hand side. The sleeve should be attached to the left hand side armhole.

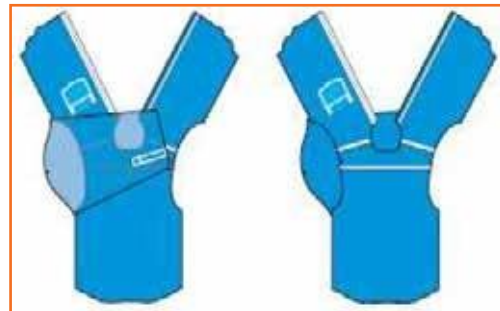

- Step 2:** Match the left front piece with the armhole. Place the shirt front above and the sleeve piece below.



- Step 3:** Attach the left front with the left sleeve with a 1 cm stitch.



- Step 4:** Take the right sleeve and place it on the machine. Ensure that the longer cut portion is to the left and facing away from you.



**Step 5:** Match the notch marks and attach the sleeve armhole with the body armhole by putting a 1 cm stitch.



**Step 6:** Put an over-lock stitch at both the armholes. If top-stitch is required on the armhole, the sleeve should be kept up and the body part of the shirt should be kept down while putting the over-lock stitch. In case top-stitch is not required, the body part of the shirt should be kept up and the sleeve down.



**Step 7:**

- While putting top-stitch, keep the margin towards the body. Put an edge stitch followed by a 4 mm top-stitch.
- Repeat the above steps for the other sleeve piece.

### 3.2.2.11 Side Seam

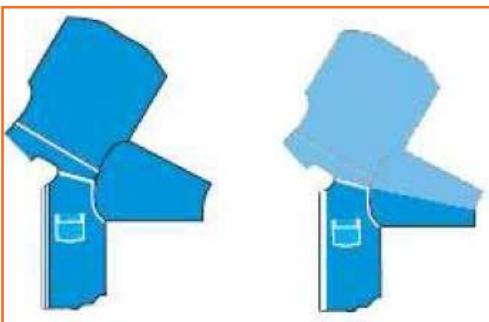

**Step 1:** Match the armhole and align the loose ends.

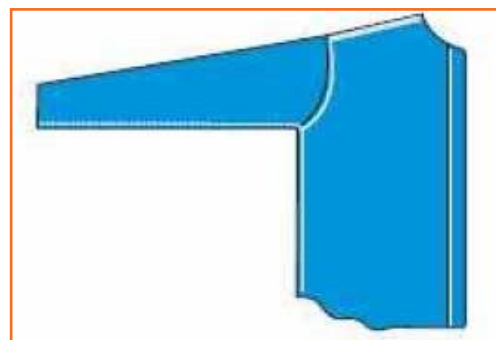

**Step 2:** Take the right hand sleeve. Stitch 1 cm from the sleeve bottom and continue till side bottom.

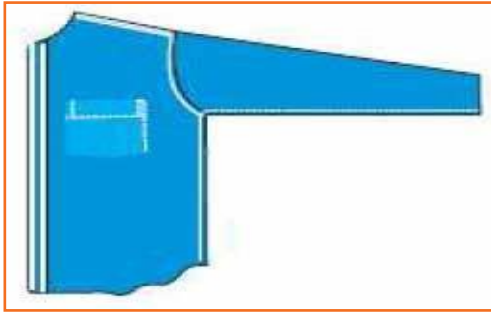

**Step 3:** Take the left hand sleeve. Stitch 1 cm from the side bottom up to the sleeve bottom.

- Turn the fabric margin towards back side and sew the top-stitch by first sewing edge stitch and then 4 mm stitches on both the sides.

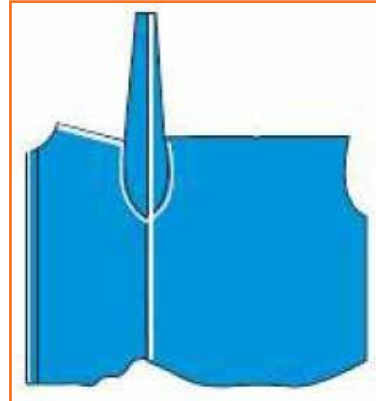

**Step 4:** • Put the over look stitch on both sides, keeping the front part on the top.

### 3.2.2.12 Collar and Neckband Preparation

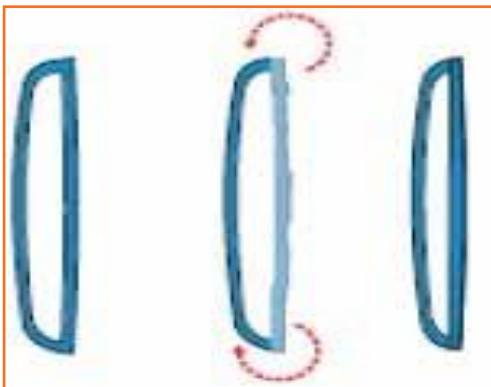

**Step 1:** Take the fused neckband piece. Turn the bottomed of the piece with your hand.

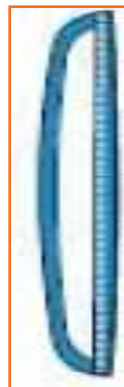

**Step 2:** Turn the fusing side down. Put a 4 mm stitch at the top.

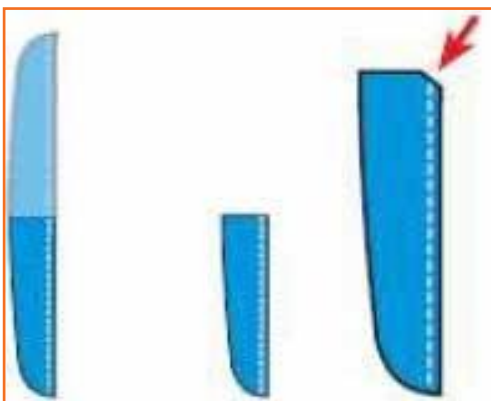

**Step 3:** Fold the neckband and cut a notch at the center of the upper side.



**Step 4:** Take the fused collar piece and place it on the collar piece that is not fused. The right side of the fused collar should face the right side of the unfused collar.

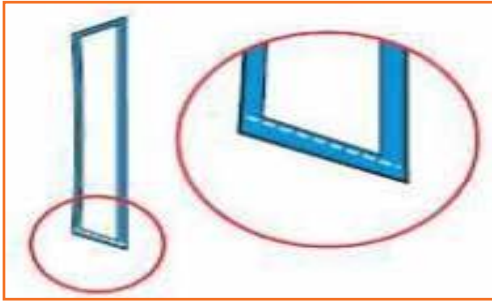

**Step 5:** Start stitching at a gap of 1 mm from the fusing material from the collar base side.

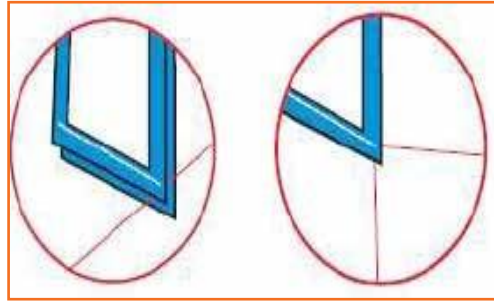

**Step 6:** Stop the sewing machine one stitch before the collar point with the needle down. Insert an extra thread between the two fabric layers touching the needle.



**Step 7:**

- Put one stitch and stop the sewing machine with the needle down. The thread will be at the back of the needle side.
- Hold both ends of the thread and bring it towards the other side of the collar.
- Put stitches at a distance of 1mm from the fused material on the remaining collar.
- Repeat steps 6, 7, 8, and 9.



**Step 8:** Now, put stitches at a distance of 1 mm from the fused material.

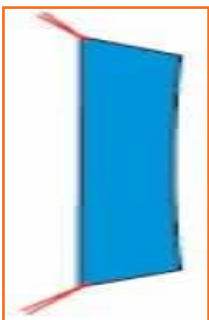

**Step 9:**

- Put back tack stitch at both the ends.
- Cut both the collar points and turn the collar.
- Stretch the threads to give proper shape to the collar.

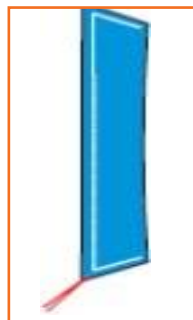

**Step 10:** Put a 4 mm stitch on all three sides of the collar. Keep the lower fabric stretched to avoid wrinkles.



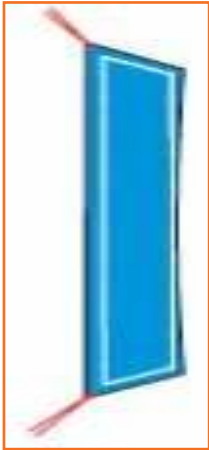

**Step 11:** Put a 2 mm stitch on the open side of the collar.



**Step 12:** Put edge stitch on the three sides of the collar.

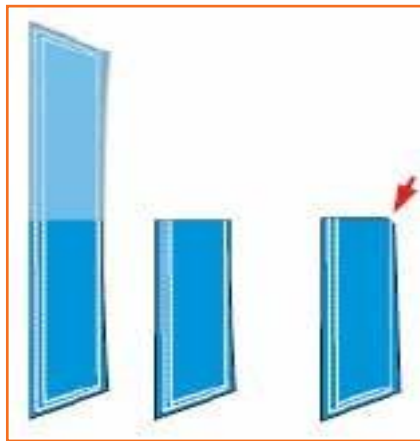

**Step 13:** Fold the collar and put a notch mark at the centre.

### 3.2.2.13 Collar and Neckband Attachment

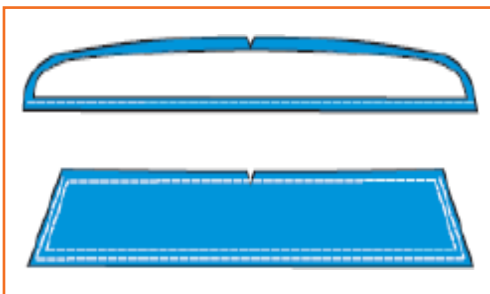

**Step 1:** Place the neckband and collar face to face.



**Step 2:** Align the notch and the band of the collar.

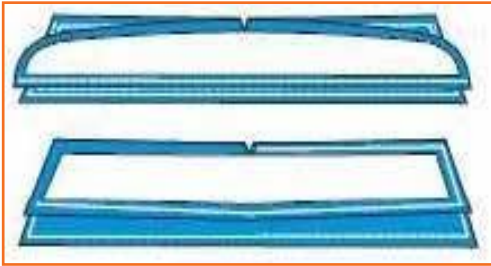

**Step 3:** Start stitching from the notch point leaving a gap of 1 mm. Repeat this stitch from the notch point to both ends.

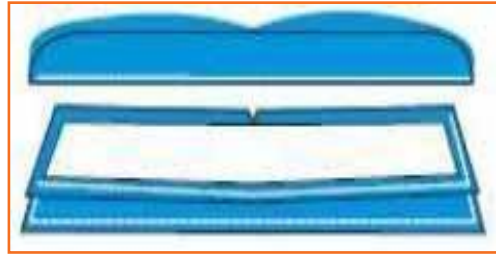

**Step 4:** Take the other neckband piece without fusing. Place it below the ready neckband collar piece.

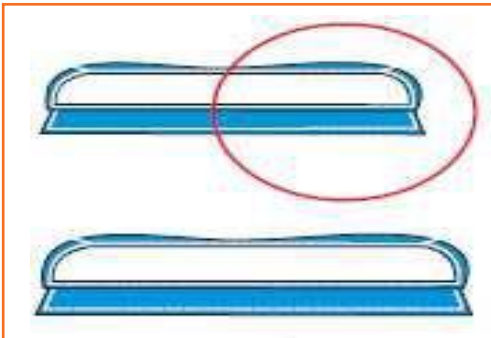

**Step 5:** Now, start stitching from the neckband bottom portion, till the other end.

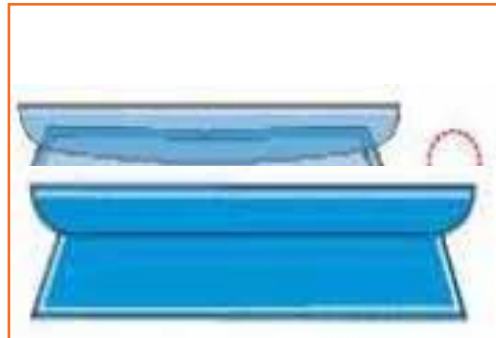

**Step 6:** Turn the neckband piece.

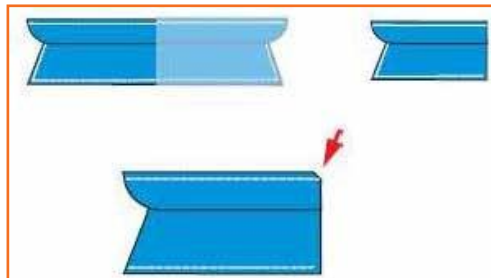

**Step 7:** Fold the piece and put a notch at the centre. The folded part is now refolded and another notch is put.

### 3.2.2.14 Collar Attachment to Body



**Step 1:** Match the three notches on the neckband with the two shoulder seams of the body and the centre notch.



**Step 2:** Keep the left hand side with face up on the Fig. Match the edge of the front placket with the edge of the collar band.

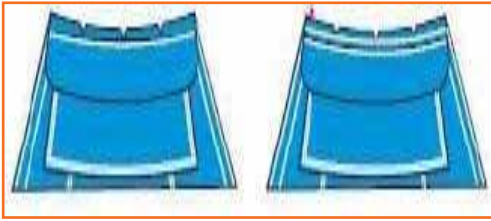

**Step 3:** Put the stitch just below the fused portion of the band till the end.



**Step 4:** Starting from the neckband's centre, put edge stitch towards the right side.



**Step 5:** Turn and continue to put edge stitch till the other end.

### 3.2.2.15 Cuff Preparation

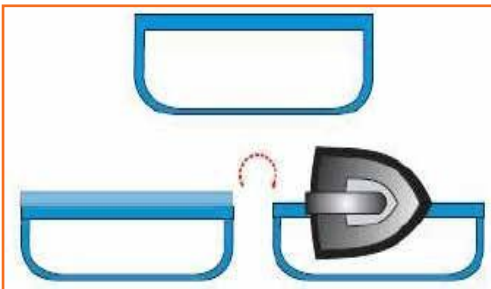

**Step 1:** Fold the fabric edges on the straight side of the cuff and iron it.

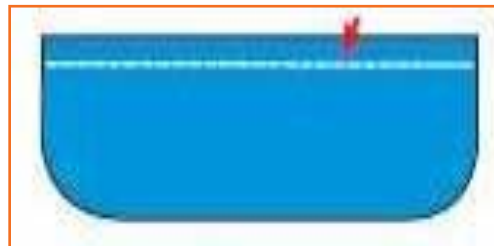

**Step 2:** Put a 4 mm top-stitch.



**Step 3:** Take the unfused piece of the cuff and place it below the fused cuff .



**Step 4:** Stitch the two curved and one straight side by leaving a 1 mm gap.



**Step 5:** Turn the cuff .



**Step 6:** The unfused cuff fabric should be 1 mm extra.

### 3.2.2.16 Cuff Attachment to Sleeve



**Step 1:** First, check that there are 4 notches for sleeve pleats and one notch at the centre of sleeve bottom.

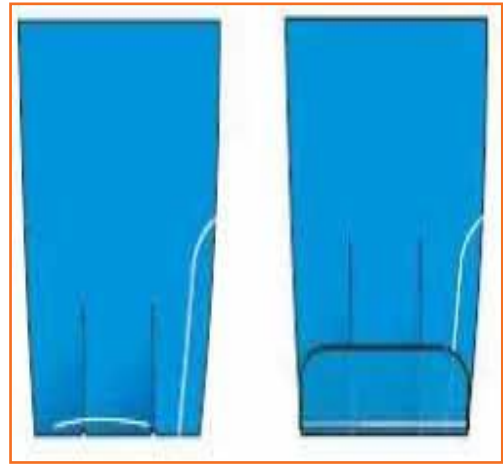

**Step 2:** Make sleeve pleats by overlapping the notches and stitching it in such a way that the pleats remain open from the edges.

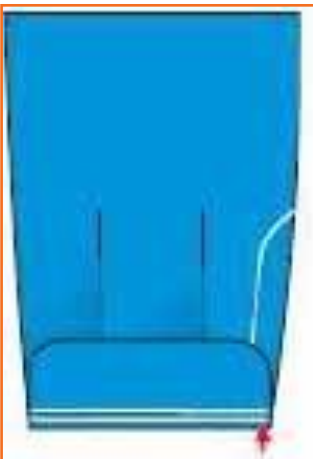

**Step 3:**

- Place the cuff with fused side up on the inner side of the sleeve.
- Stitch just below the edge of the cuff .



**Step 4:** Straighten the cuff . Put the excess fabric inside the cuff and put stitches at the edge.



**Step 5:** Now put the edge stitch throughout the cuff.



**Step 6:** Now put 4 mm stitch throughout the cuff. Repeat Steps 1 to 7 for the second cuff.

### 3.2.2.17 Bottom Hemming



**Step 1:** Match the collar band tip to bottom.



**Step 2:**

- Fold the bottom (as per requirement) and put edge stitch from the left front side to the right side.
- Close the two ends.

### 3.2.2.18 Button-holing

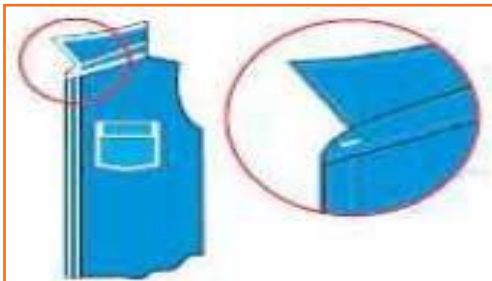

**Step 1:**

- Take the left hand side placket.
- Make one button hole on collar band parallel to the band at the center and about 1 cm from the edge.



**Step 2:**

- Along the centre of the placket width, mark the button holes at a distance of 9 cm from each other from the collar band button hole.
- In case of cuff , mark button hole at the centre of the cuff on upper placket side.
- Make button holes using buttonhole machine. Themarking should come in the middle of the buttonhole.

### 3.2.2.19 Button Attaching



**Step 1:** Keep the left hand and right hand plackets on top of each other. They should be properly aligned.

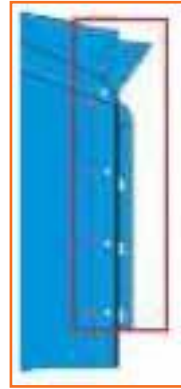

**Step 2:** Put a mark at the Centre of the button-hole using a chalk.



**Step 3:** Attach buttons at the marked positions using the button sew machine.



**Step 4:** Repeat the same procedure for the cuff.

### 3.2.3 Stitching a Saree Blouse

#### Measurements needed

- Chest
- Full length of the blouse
- Shoulder
- Sleeve length
- Sleeve round
- Front length-Measured from shoulder along the highest point of bust to where bra cup ends.

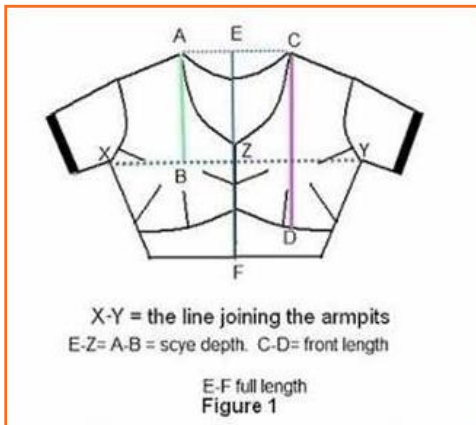

Fig 3.2.3(a): Drafting of a saree blouse

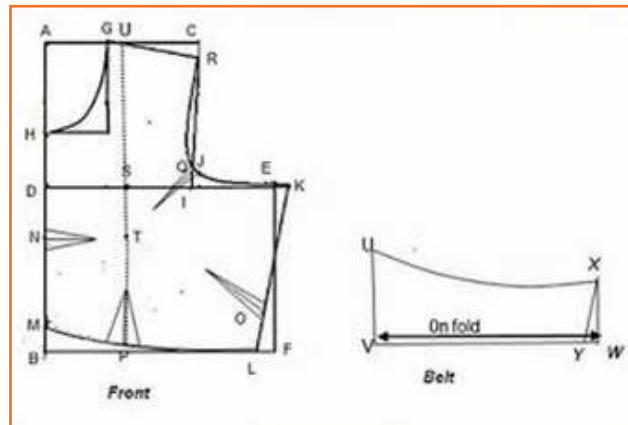

Fig 3.2.3(b): Drafting of a saree blouse

### Process

- Front A to B = front length +  $\frac{1}{2}$ "
- A to C =  $\frac{1}{2}$  shoulder +  $\frac{1}{4}$ "
- On the line A-B mark D such that A-D =  $\frac{1}{4}$  chest -  $\frac{1}{4}$ " or  $1\frac{1}{2}$ "

A-D is called scye depth. It varies with chest measurement. It can be calculated using the chest measurement. It can also be measured directly on the body. It is measured from the nape of the neck downwards to a line that joins armpits.

### Scye depth for various breast measurements:

- 28" to 30" =  $\frac{1}{4}$  chest -  $\frac{3}{4}$ " to 1"
- 31" to 33" =  $\frac{1}{4}$  chest - 1" to  $1\frac{1}{4}$ "
- 34" to 36" =  $\frac{1}{4}$  chest -  $1\frac{1}{2}$ " to 2"
- 37" to 39" =  $\frac{1}{4}$  chest -  $2\frac{1}{4}$ " to  $2\frac{3}{4}$ "
- 40 to 42 =  $\frac{1}{4}$  chest - 3" to  $3\frac{1}{2}$ "
- Draw perpendicular lines from the points D and B to the line A-B.
- On the line A-C mark G such that A-G = the neck width =  $\frac{1}{8}$ th chest or to taste.
- Mark H on A-B such that A-H = neck depth =  $\frac{1}{8}$ th chest or to taste.
- Shape front neck curve H-G.
- Mark D-E =  $\frac{1}{4}$  chest + 1 +  $\frac{1}{2}$ ".
- Mark F such that B-F = D-E.
- Produce D-E to K such that E-K =  $\frac{1}{2}$ ".
- Mark L on B-F such that L-F =  $\frac{1}{2}$ ". Join K-L.
- On the line D-E mark point I such that D-I =  $\frac{1}{2}$ " less than A-C. Join I-C.
- On the line I-C mark point R such that C-R =  $\frac{1}{2}$ " or  $\frac{3}{4}$ ".
- Join G-R. On the line I-C mark a point J such that I-J = 1".
- Shape the scye round R-J-E-K.



- On the line D-E mark a point S such that  $D-S = \frac{1}{12} \text{th chest} + \frac{3}{4}''$ .
- On the line A-B mark point M such that  $B-M = 1''$ .
- Join M-L by a curved line as shown in the figure.
- Drop a perpendicular from the point S.
- This line meets the curved line M-L at P. On this line Mark point T which is the bust point It can be marked in two ways:
  1. Mark T such that distance  $S-T = \frac{1}{8} \text{th chest} - 1\frac{1}{2}''$ .
  2. Actual bust length is measured from the shoulder line to the highest point of the bust. Mark T along the line U-T passing through S such that U-T is equal to is the bust length.

**Darts:**

- All the darts should point towards the bust point T and end  $\frac{1}{2}''$  away from T.
- Mark N on the line A-B such that  $D-N = S-T$ . Take  $\frac{1}{2}''$  or  $\frac{3}{4}''$  dart
- At point P a dart of  $1\frac{1}{4}''$  to  $2''$  dart of required length is taken
- On the line K-L mark a point O such that  $O-L = 1''$  take a dart of  $\frac{3}{4}''$  wide and of required length.
- At the point J take a dart of  $\frac{1}{2}''$  wide of required length.

**Belt:**

- $U-V = \text{Full length of the blouse} - \text{Front length} + \frac{1}{2}''$ .
- $V-W = B \text{ to } F - 1\frac{1}{2}''$  (size of the dart taken).
- $W-X = U-V - 1''$ .
- Shape the curve U-X identical to the curve M-L.
- $Y-W = \frac{1}{2}''$ .
- Join X-Y.

**Back:**

- $A-B = \text{Full length of the blouse} + 1''$
- A-D is scye depth = same as scye depth of front the blouse.

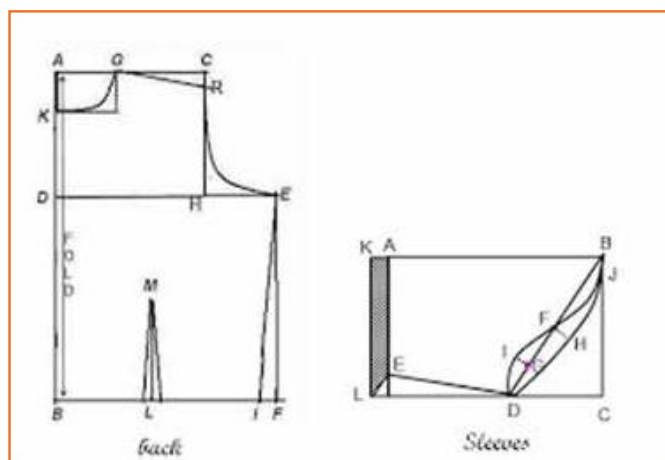

Fig 3.2.4: Back and sleeve of a saree blouse

- Draw perpendiculars from A,D and B.
- $A-C = \frac{1}{2}$  shoulder +  $\frac{1}{4}$ ". Mark  $D-E = \frac{1}{4}$  chest +  $1\frac{1}{2}$ ".
- Mark F such that  $B-F = D-E$ .
- $I-F = \frac{1}{2}$ ". Join E-I.
- On the line A-C mark G such that  $A-G =$ the neck width =  $\frac{1}{8}$ th chest or to taste.
- Mark K on A-B such that  $A-K =$  Back neck depth =  $\frac{1}{12}$ th chest or to taste.
- Shape back neck curve K-G.
- On the line D-E mark H such that  $D-H = A-C$ .
- Join H-C. On the line H-C mark a point R such that  $C-R = 1$ ".
- Shape the Back scye round R-E.  $B-L = \frac{1}{12}$ th chest +  $\frac{1}{2}$ ".

A dart L-M of  $\frac{1}{2}$ " width and of required length is taken here.

- Sleeves  $A-B =$  sleeve length +  $\frac{1}{2}$ ".
- $K-A = 1$ " for folding.
- From the points B , A and K draw perpendiculars.
- $B-C$  is as  $A-D =$  scye depth of the body taken while drawing body draft +  $\frac{1}{2}$ " to  $1\frac{1}{2}$  ".
- For smaller sizes  $B-C$  is equal to the scye depth .
- $B-C = K-L$ .
- Join C-L.
- Mark D on the line C-L such that  $D-C = \frac{1}{8}$ th chest -  $\frac{1}{2}$ ". It should be between 3 to  $3\frac{1}{2}$ "  $B-J = 1$ ".
- Join D-B .F is the middle point of  $D=B$  .  $F-H = \frac{3}{4}$ " G is the middle point of  $D-F$ .  $I-G = \frac{1}{2}$ "
- Shape the front scye curve of the sleeves  $D-I-F- J-B$  and Back scye curve of the sleeves  $D-H-J-B$ .  $A-E = \frac{1}{2}$  sleeve round + 1" for seams.
- Join L-E.

#### Parts of a blouse:

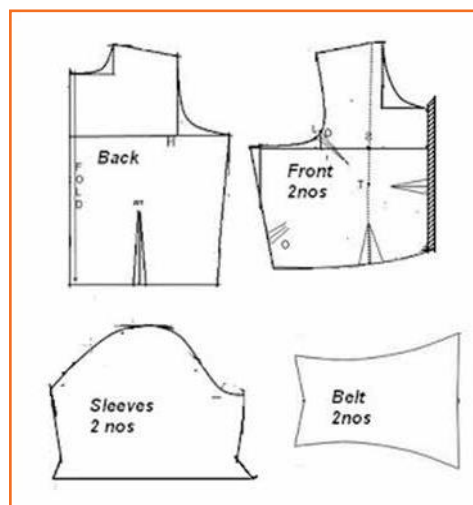

Fig 3.2.5: Parts of a saree blouse

- Prepare the draft and separate each part.
- Label all pattern pieces.
- Mark "place on fold" on the center-line of the back.
- Add 1/2" extension along the line of opening of the front to attach button-stands.(shown by shaded area)
- Mark the center of sleeve top.
- Place the parts of the draft on the fabric and cut the parts

**Stitching:**

- **Step 1** Stay stitch neck, arm scyes and sleeve top.
- **Step 2** Stitch darts.
- **Step 3** Attach the belt to the body.
- **Step 4** Stitch button stands. Right side should overlap the left side. Extension is stitched to the left side and right side is finished with a facing.
- **Step 5** Join shoulders.
- **Step 6** Finish neck line with Piping or flat facing.
- **Step 7** Hem the lower edge of the sleeves and back.
- **Step 8** Attach sleeves to the body, matching center line of the sleeves to the shoulder line and easing wherever necessary.
- **Step 9** Stitch sides of the sleeves and body.
- **Step 10** Sew hook on the underside of right button stand and work eyes on the right side of left front facing.

### 3.2.4 Stitching a Kurta/Kameez

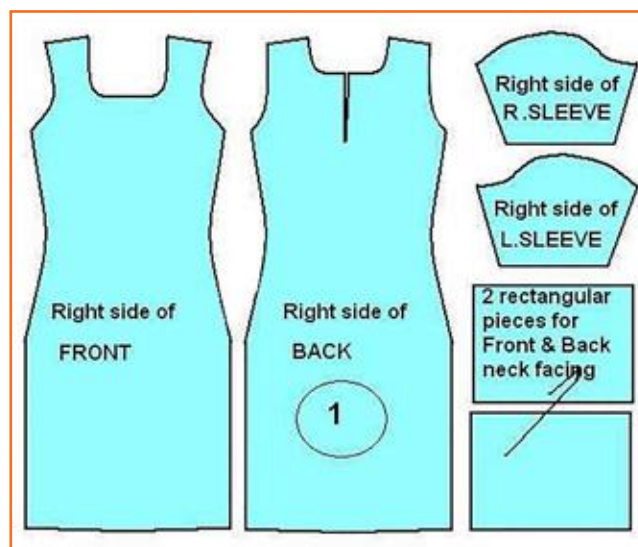

**STEP 1:** Take 2 Pieces of Kameez (Front and Back) 2 Pieces of Sleeve (Right and Left) and 2 rectangular pieces for Neck facing.

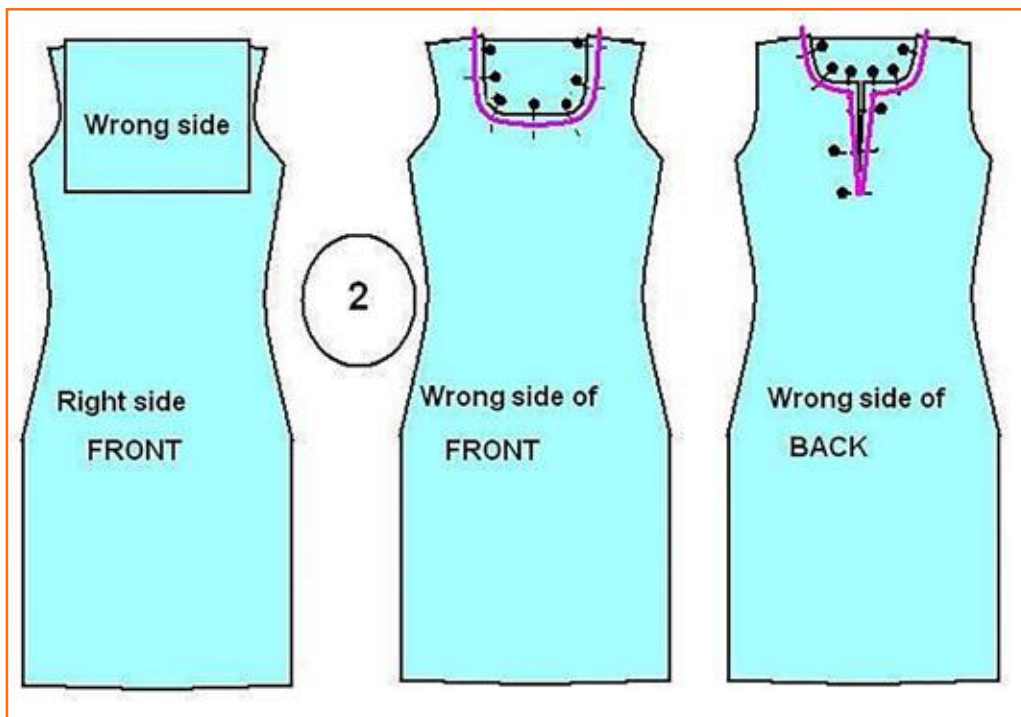

**STEP 2:** Place the neck facing rectangular pieces for the front and back Kameez pieces respectively. Make sure that the right sides are together. Pin and sew along the neck line with  $\frac{1}{4}$ " seam allowance. Cut the excess of facing pieces and make notches on seam. Then turn right sides out and press. Give topstitch at neckline.

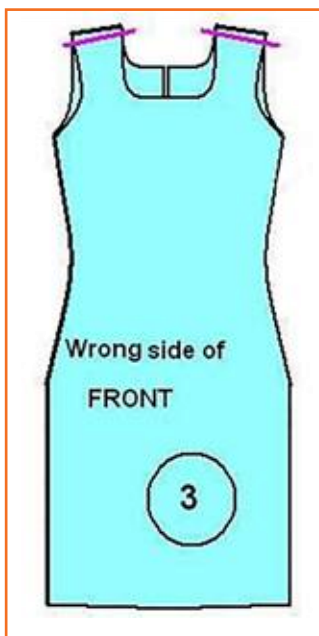

**STEP 3:** Place Kameez front and back pieces by facing right sides together and sew along the shoulder line to joint the two Kameez pieces together.

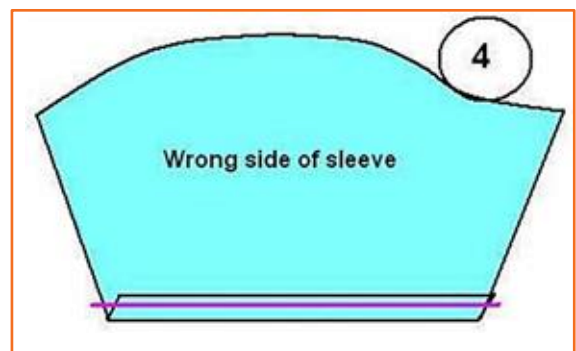

**STEP 4:** Fold the hemline of sleeve by  $\frac{1}{4}$ " inside and fold again  $\frac{3}{4}$ " inside and sew along the hemline at the edge of first folding.

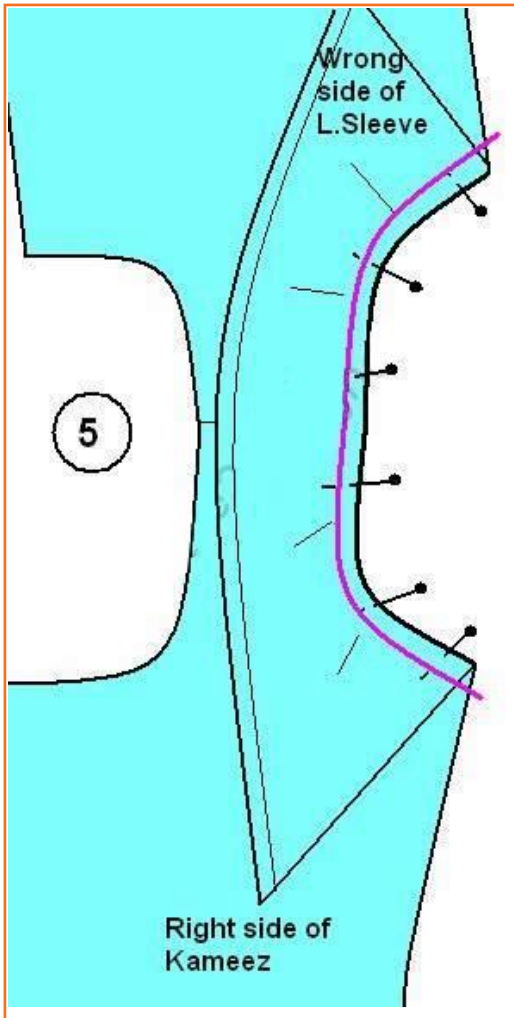

**STEP 5:** Place the Sleeves right side on the top of Kameez armhole area respectively. Pin it and sew along with  $\frac{1}{4}$ " armhole seam allowance.

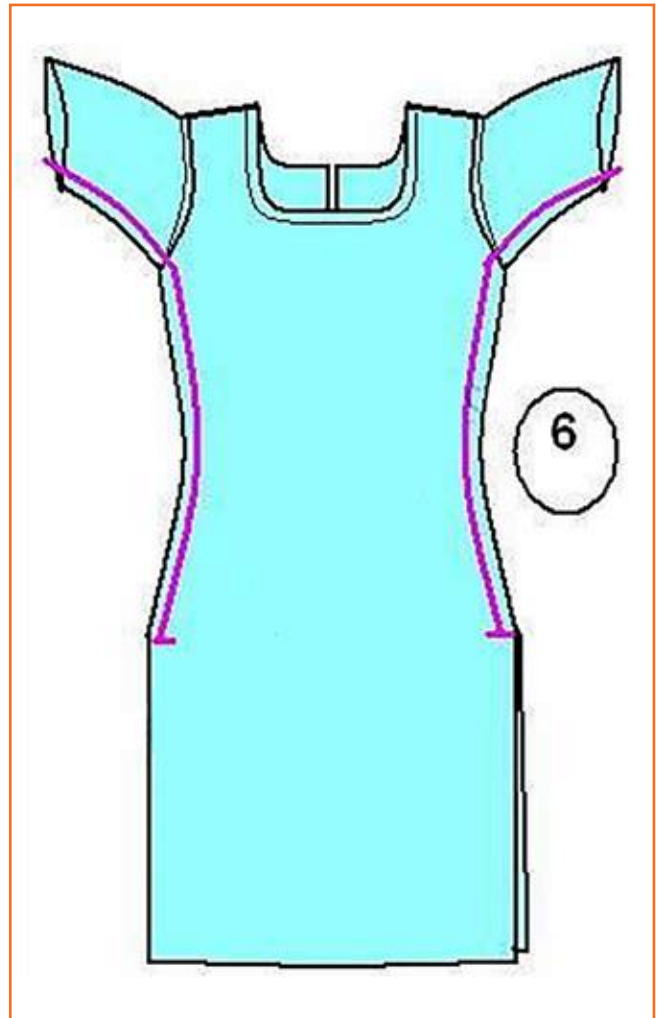

**STEP 6:** Turn Kameez wrong side out and sew along with 1" side seam allowance as right sides together (Start from Sleeve's hemline and stop at the Hip line of Kameez).

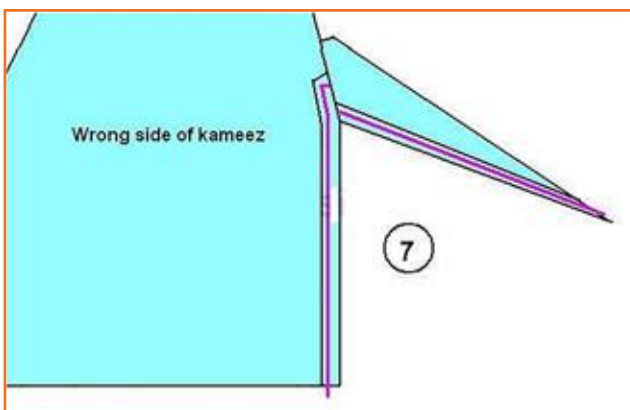

**STEP 7:** Fold at the slit opening  $\frac{1}{4}$ " inside and fold  $\frac{1}{4}$ " again. Then sew along the slit opening of both sides. Press with iron.

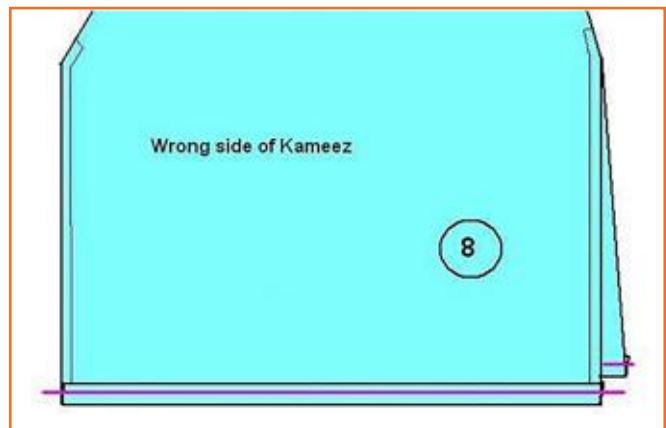

**STEP 8:** Fold the hemline  $\frac{1}{2}$ " inside and fold 1" again. Then sew along the edge of first fold on hemline.

### 3.2.5 Stitching Button and Button Holes

**Buttons:** The various types of buttons available in the market differ in that they have different number of holes – 2 or 4. The method for fixing them remains the same. The spot where the button needs to be fixed is determined and then the needle is taken out first from one and then the other to properly fix the button. There should be a little looseness in the stitch so that the button can be easily passed through the button hole.



Fig 3.2.6: Button attaching

#### Button hole

Of utmost importance in the tailoring trade, as it is used on almost all types of garments – ladies, men's and children. There is a need to keep an opening somewhere on the garment for ease of wearing and taking off. Most of such openings are closed with the help of buttonhole stitches. The button hole is always made on the top portion. The buttonhole stitch is used to finish the button hole. It is made on two or more layers of cloth. The button hole has a slight curve on one side known as the fan and an edge on the other known as the bar.



Fig 3.2.7: Button hole making by machine



Fig 3.2.8: Button hole making by hand

**Method:** First choose the distance between each button hole. Then keeping the diameter of the button in mind, use the tip of a scissor to cut holes in the cloth. To ensure that no, loose strands come out finish the edge with a temporary stitch. Always cut the button hole in the direction of the grain line. Then using a single thread finish the edge with a buttonhole stitch keeping a little extra tension on the 'fan' side to make a kind of chain stitch is then pressed down once the buttonhole is finished.

#### Hook and eye

An opening can be closed with other methods apart from a button and buttonhole. One of these is the hook and eye. There are hooks of different sizes available to suit different purposes and garments like trousers or blouses. The hook is usually fixed half a point behind the edge of the belt. This is fixed using the buttonhole stitch. It is fixed from two edges below and one point above like a bow. The simple hooks are best used with an eye made from thread by hand, using a button hole stitch. The big hooks used for trousers usually come with a ready made eye of metal which is also affixed using a buttonhole stitch.



Fig 3.2.9: Attaching hook and eye



**Press buttons:** These are metal buttons with one part having a hole and the other a nail to fit into the hole. The nail part is always put on the top and the one with the depression on the bottom. This is also affixed using the button hole stitch.



Fig 3.2.10: Press button

## Industry Visit

The purpose of visiting a tailor shop/boutique is to get hands on knowledge about various processes involved in the work of a tailor. During the visit you have to interact with Tailors and owner of the shop to understand how work is done in a tailor shop/boutique. Make sure that you keep a notebook handy and note down any important points that come up during your interaction at the tailor shop/boutique. When you go to an tailor shop/boutique, you should:

- Recognize the different parts of a trouser.
- Analyze how an Tailor makes and attaches the pocket bag, fly, zip, back rise and front and back pieces to trouser.
- Also observe how he makes and attaches the belt loop, bottom hemming and button and button holes to a trouser.
- Recognize the different parts of a shirt.
- Analyze how an Tailor makes and attaches the left and right hand side placket, pocket, yoke, placket to sleeve, sleeve, side seam, collar and neckband, cuff and bottom hemming etc.
- Also observe how he makes button holes and attaches the buttons to shirt.
- Similarly observe other stitching operations like button hole making and attaching in different garment such as saree blouse, kurta etc.
- Ask questions to Tailors/shop owners if you have any query.



## UNIT 3.3: Knowledge of Basic Embroidery Stitches

### Unit Objectives

At the end of this unit, participants will be able to:

1. Practice flat stitches, loop stitches and knotted stitches.
2. Carry out flat stitches, loop stitches and knotted stitches.

### 3.3.1 Flat Stitches

Flat stitches are simple embroidery stitches in which individual stitches are made without crossing or looping the thread. These stitches are used to form broken or unbroken lines or starbursts, fill shapes and create geometric designs.

Commonly used types of Flat Stitches and their techniques are given below:

- Running Stitch
- Back Stitch
- Stem Stitch
- Satin Stitch
- Kashmiri Stitch
- Couching Stitch
- Cross Stitch
- Herringbone Stitch

### 3.3.2 Steps of Carrying out Running Stitch

This stitch can be worked in straight or curved lines, or for assembly when finishing an embroidery project. The stitch is worked by passing the needle in and out of the fabric. Running stitches may be of varying length, but typically more thread is visible on the top of the sewing than on the underside.

- **Step 1:** Work from right to left of the fabric and insert your needle through the back side of the fabric at your starting point
- **Step 2:** Bring thread up at 1 then down at 2, up at 3 and down at 4 and continue
- **Step 3:** The spaces between the stitches can be the same length as the stitches or shorter for a different look.



### 3.3.3 Steps of Carrying out Back Stitch



The back stitch is a basic embroidery and sewing stitch used to produce a thin line of stitching, to outline shapes that will be filled with satin stitch, or to stitch fabric pieces together.

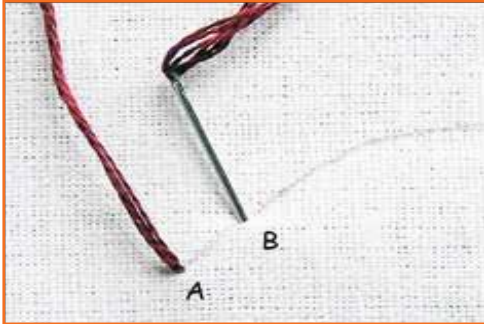

**Step 1:** Bring the thread through A and take it in through B. This creates one stitch

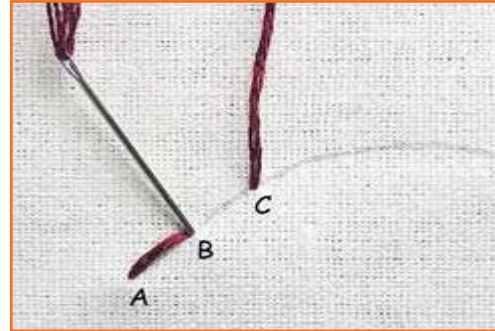

**Step 2:** Bring the thread through C and take it in through B. This way, we are creating a stitch by taking the thread backward

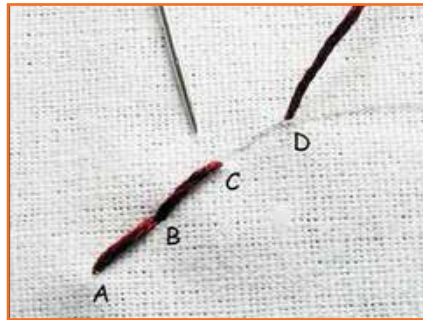

**Step 3:** Bring the thread through D and take it in through C. Continue this pattern to finish the design

### 3.3.4 Steps of Carrying out Stem Stitch



Stem stitch, and its variations, are worked as a thin line and can be used to outline embroidered shapes, stitch lines and curves, embroider letters. This stitch creates a rope like appearance

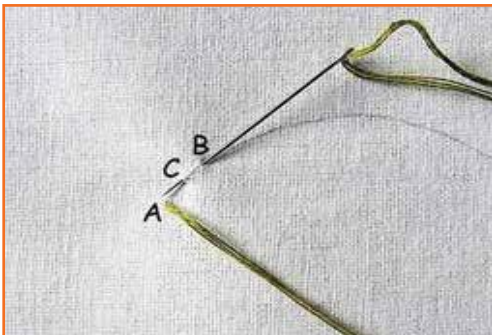

**Step 1:** Bring out the thread through A and take it in through B. Take the needle backwards and bring the thread out through C. Make sure the point C lies over the stitch A-B

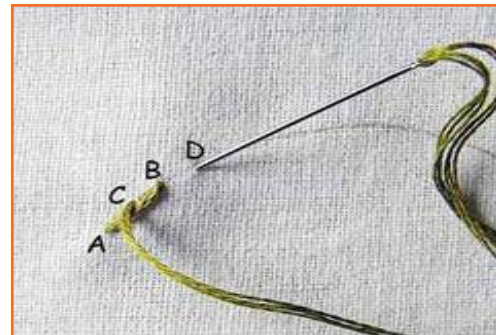

**Step 2:** Note that the point C lies about half way through A and B. Also note that C lies on top of the stitch A-B. So, all the subsequent stitch points will lie on top their previous stitch.

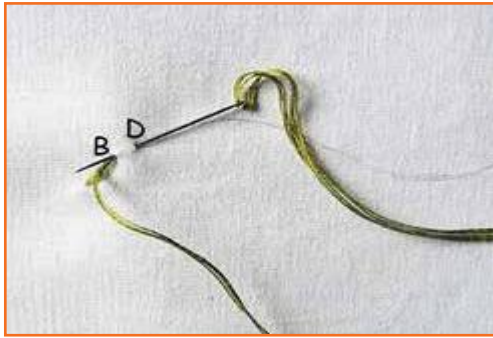

**Step 3:** Take the needle in through D. Try to mark D in such a way that the point B will lie half way through C-D. Bring the needle out through B



**Step 4:** The pattern of two stitches of the stem stitch will be as shown in figure



**Step 5:** Continue this pattern of stitching with the needle coming out through the top of the previous stitch always

### 3.3.5 Steps of Carrying out Satin Stitch

This stitch is primarily used for Solid filling for shapes and monogram. Often, a satin stitch is outlined using one of the straight stitches like, the split stitch, the outline stitch, back stitch, chain stitch, or any other similar stitches. This helps in containing the satin stitch within the parameters of the pattern/design easily.

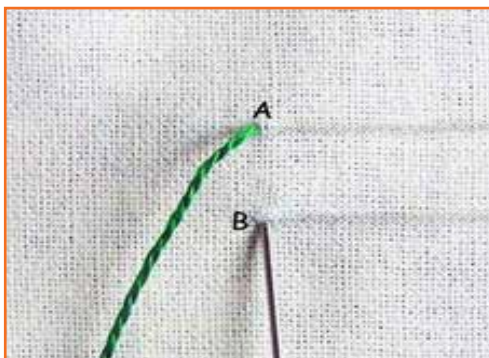

**Step 1:** Bring the needle out through A and put it in through B. So, that makes a stitch which covers a small area between the stitch lines

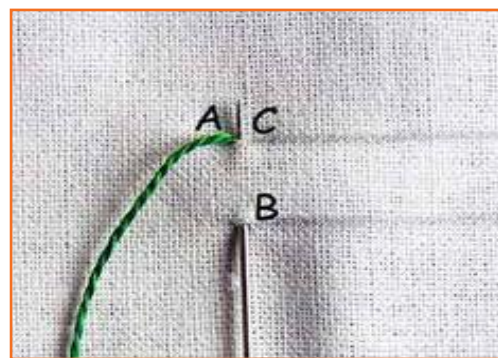

**Step 2:** Bring the needle back through C, a point very close to A. Continue this action over the two stitch lines





**Step 3:** Once finished, the area is filled as in figure. Almost same amount of thread will be spent on the reverse side as on the actual side of the fabric

### 3.3.6 Steps of Carrying out Couching Stitch

This stitch is usually used to make outlines, or layers of this stitch can be made to fill in patterns. This stitch involves two threads: a thicker foundation thread, (also called the laid thread) and a thinner thread (called the couching thread).



**Step 1:** Start by bringing out a thread (brown in the figure) for laying from one end of the stitch line. Keep it open. Now, bring another thread (red in the figure) out, a little outside the stitch line, and away from the other thread.



**Step 2:** Keep the laid thread over the stitch line. Use the other thread to fasten the laid thread down using a small stitch.



**Step 3:** After fastening, the stitch will look like as in the figure.



**Step 4:** Bring the fastening thread out as a short distance from the earlier stitch. Lay the open thread over the stitch line, and again fasten it down with a small stitch.



**Step 5:** Continue with this method for the entire stitch line. To finish up, pass the laid thread through the fabric and knot it. Make sure the fastening thread is brought out at regular intervals to make it look elegant.



**Step 6:** A finished couched line will look like this.

### 3.3.7 Steps of Carrying out Cross Stitch



This stitch is used for borders and filling if worked in adjacent rows.

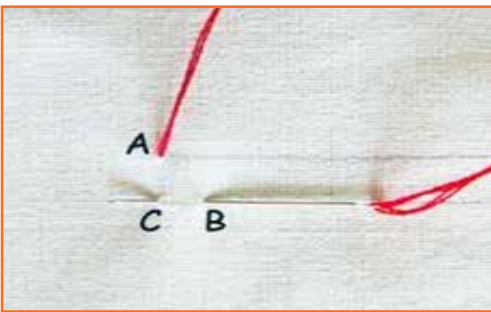

**Step 1:** Bring the needle out through A and take it diagonally across to B. Bring it back again through C, which lies vertically below A

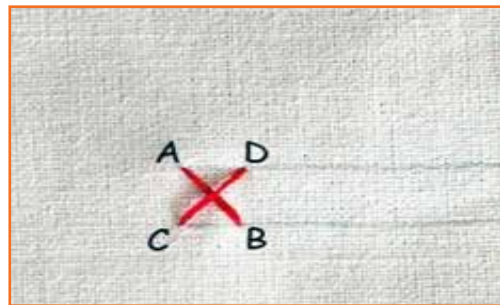

**Step 2:** Now put the needle in through D, which lies vertically above B. You have made a single cross

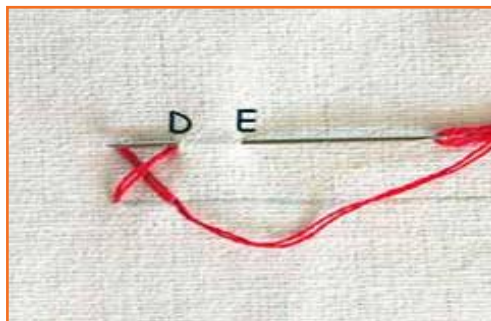

**Step 3:** Continue by putting the needle in through E and bring it out through the previous point D

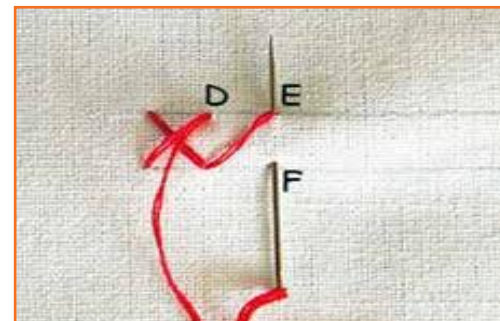

**Step 4:** Put the needle in through F to complete the second cross. Now, bring the needle out through the previous point E to begin for the third cross. Continue this process

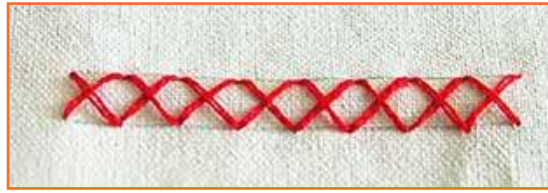

**Step 5:** A row of cross stitch would appear like this.  
The same technique is followed for a vertical row

### 3.3.8 Steps of Carrying out Herringbone Stitch

This type of stitch is used to create border, edging, can be stitched over a ribbon or braid to hold it down. It is ked along parallel lines on an evenweave fabric

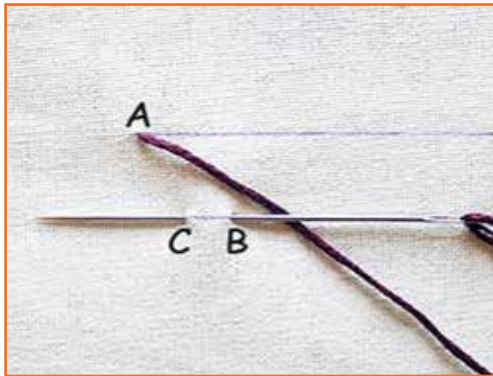

**Step 1:** Bring the needle out through the first stitch line at A. Now, take the needle in through B, which lies diagonally across A on the second stitch line. Then, take the needle backwards out through C, which lies near B.

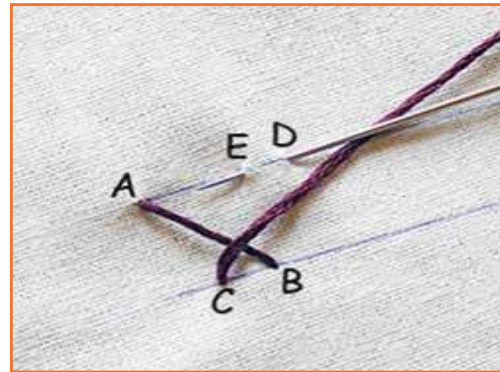

**Step 2:** Now, the same procedure will be worked on first stitch line. Take the needle diagonally across to D and bring the needle backwards out through E

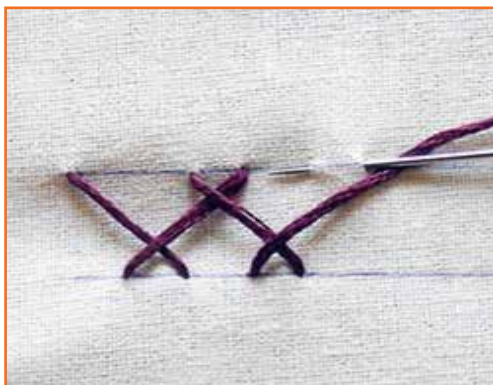

**Step 3:** Continue to make such crosses on both stitch lines alternately. Make sure the diagonal stitches are parallel to each other to bring out the best look



**Step 4:** A finished sequence of herringbone stitch would look like this



### 3.3.9 Loop Stitches

Loop stitch gets its name from the long loops it leaves behind

Commonly used types of Loop Stitches and their techniques are given below:

- Chain stitch
- Button-hole stitch
- Blanket Stitch
- Fish bone stitch
- Feather stitch
- Fly Stitch

### 3.3.10 Steps of Carrying out Chain Stitch

The chain stitch is a looped stitch that can be worked along a curved or straight line. Variations of this stitch including the single or detached chain, lazy daisy, feathered chain, square chain, cable chain, heavy chain, zig-zag chain and many more. This stitch is commonly used for outlining, straight and curved lines, filling if rows are stitched closely together

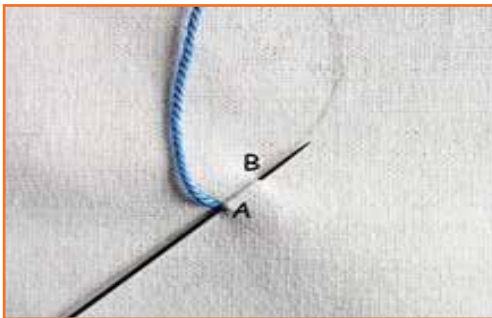

**Step 1:** Bring the thread out through A. Put the needle back in A and bring it out through the point B, but don't pull the needle out completely.

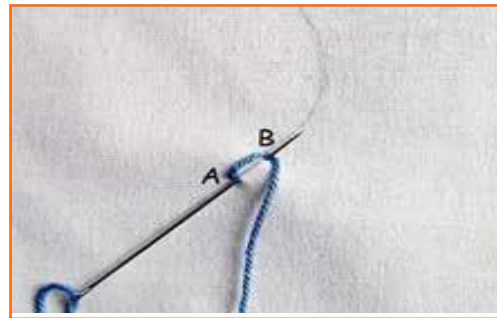

**Step 2:** Take the thread around the needle from left to right to form a loop

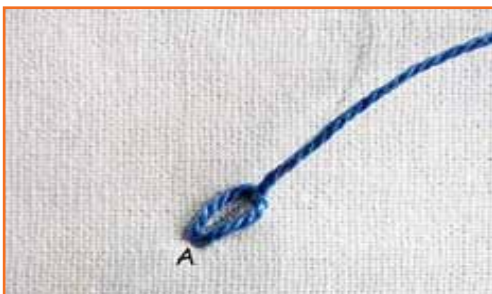

**Step 3:** Pull out the needle now to tighten the loop and you will get the first part of the chain.

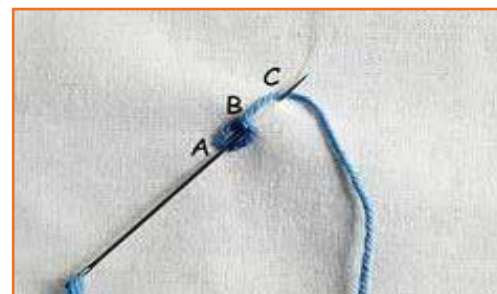

**Step 4:** Put the needle in through B (now inside the loop) and bring it out on C (outside of the loop).





**Step 5:** Continue the action by taking the thread around the back of the needle from left to right to form a loop and pull out the needle to get the next loop of the chain. Keep on with this procedure to finish the design.

### 3.3.11 Steps of Carrying out Button Hole Stitch

This stitch is used to secure the edges of buttonholes as it gives a much sturdier stitch due to the knots it makes.

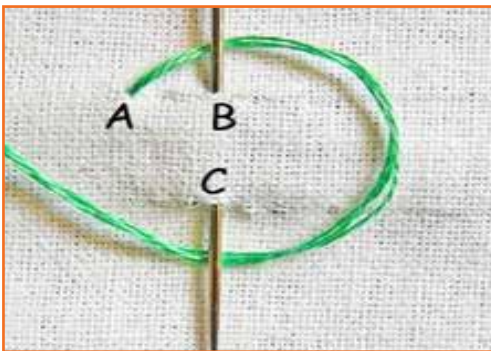

**Step 1:** Bring the needle out through A. Now, loop the thread around from left to right. Take the needle in through B and bring it out from C. Keep the thread below the needle always

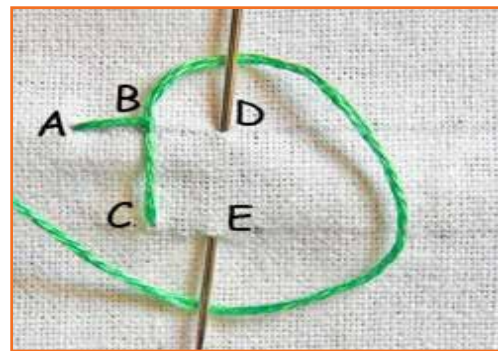

**Step 2:** Pull out the needle towards the top. This creates a small knot near the point B. Do not pull the needle downwards as it will not give the desired results



**Step 3:** A finished portion of the buttonhole stitch would look like as in figure

### 3.3.12 Steps of Carrying out Blanket Hole Stitch

This stitch is called blanket stitch as traditionally it is used to stitch the edges of blankets. It is used to create straight and gently curved lines, borders and finishing edges

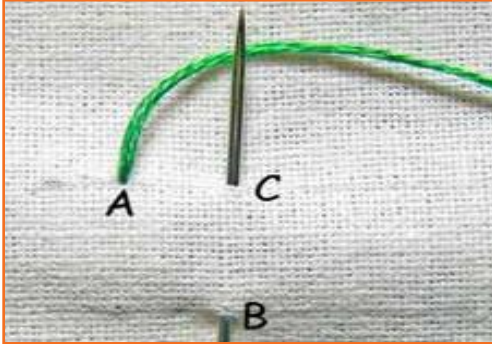

**Step 1:** Bring the needle out through A. Take the needle in through B. Take it out through C, a point in the same stitch line as A. Loop the thread under the needle

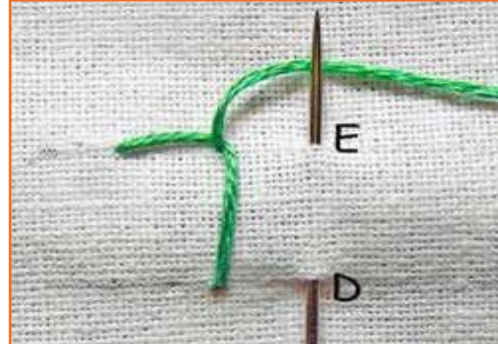

**Step 2:** Pull out the needle. Continue with this process till the end of the line



**Step 3:** A portion of the finished blanket stitch would look like as in the figure

### 3.3.13 Steps of Carrying out Fishbone Stitch

This stitch is a type of filling stitch and is used for making leaves and feathers



**Step 1:** To begin with, bring the needle out through point A, which is the top tip of line Y. Put it in through B, to make a single straight stitch.



**Step 2:** Now, bring the needle out from a point very close to A on the line X. Put it in through a point very close to B on line Y. Again pull out the needle through a point very close to A on line Z.



**Step 3:** This procedure of putting in the needle through X and Z alternatively will follow. Each time you will be connecting X-Y and Y-Z.



**Step 4:** Make sure all the stitch points lie close to each other to avoid any visible spaces.



**Step 5:** Half way through, the leaf design would look like as in the image.

### 3.3.14 Steps of Carrying out Feather Stitch

Feather stitch is a decorative stitch, usually, used to accompany it with embellishments or other forms of stitches like the French knot. It can be used to make borders, horizontal or vertical fillings, or designs with curves. It looks like a series of interconnected 'V's.



**Step 1:** Bring the needle from B. Now, put the needle in through D and bring it out from C. Note that the points on Band D falls on a straight line, and C lies diagonally to both Band D. Pull the needle out with the thread under it, as shown. We would form our first 'V'

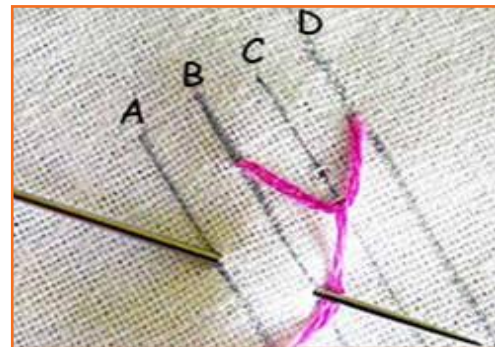

**Step 2:** Continue to put the needle in through A and bring it out through B. Pull the needle out with the thread under it as shown, to make the next 'V'





**Step 3:** Continue the procedure by putting the needle in through the outer stitch line and bringing it out from the inner stitch line. Keep alternating between left and right side to make the 'V's' - putting in the needle through A and bringing it out from B; putting the needle in through D and bringing it out from C.



**Step 4:** Once a small portion of feather stitch is done, the stitch will look like as in the figure

### 3.3.15 Steps of Carrying out Fly Stitch

This stitch is done in rows for edging or singly for accents, plants and foliage, decorative lines, interesting filling

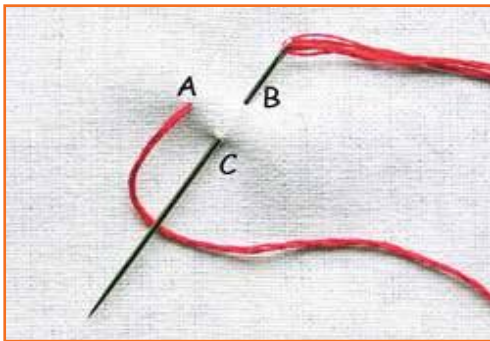

**Step 1:** Bring the needle out from A and put it in through B. Then, bring it out through C, which lies between and below A and B. Pull the needle out from over the working thread, as shown in the picture. this creates a 'V' shape.



**Step 2:** To create the 'Y' shape, we need to make a tail. Put in the needle a little space right below C.



**Step 3:** The stand alone fly stitch would look like as in the image

### 3.3.16 Knotted Stitches

A knotted stitch is any embroidery technique in which the yarn or thread is knotted around itself.

Knotted edgings are used as a decorative trims, and can also be used to fill open spaces in cut work and in needle-lace

Commonly used types of Loop Stitches and their techniques are given below:

- French Knot
- Double Knot
- Bullion Knot

### 3.3.17 Steps of Carrying out French Knot

This is one of the most commonly used knotted stitches. French knot is used to make decorative dots, filling flower centres, leaves, plants etc.

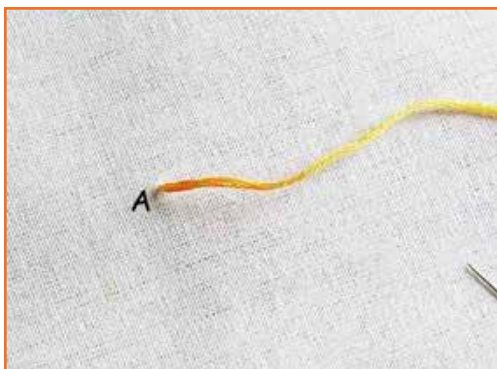

**Step 1:** Bring the needle out through A.



**Step 2:** Place the needle close to the fabric. Wrap the thread around it twice.



**Step 3:** Keep the longer end of the thread pulled with your fingers while putting the needle back in a point just close to A or even through A.



**Step 4:** Pull down the needle through the fabric. You will see your first French knot formed.

### 3.3.18 Steps of Carrying out Double Knot

It is also known as Palestrina knot stitch. This stitch is usually used for outlining or bordering purposes.

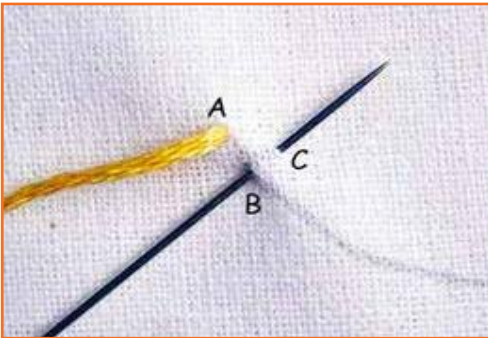

**Step 1:** Bring the needle out through the point A, which lies on the stitch line. Then, take the needle in through B, which lies on the stitch line too. Bring out the needle through C, a point straight above and not too far from B.

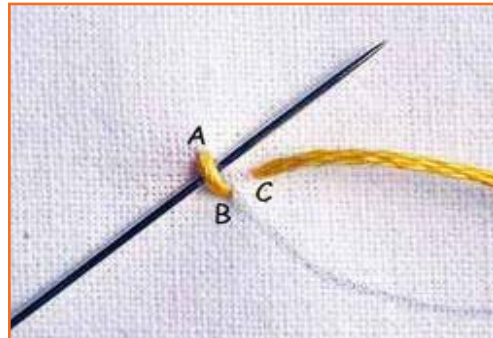

**Step 2:** Take the needle below the stitch A-B, without plucking the fabric underneath. The needle will be angled above or towards the left of the point C.

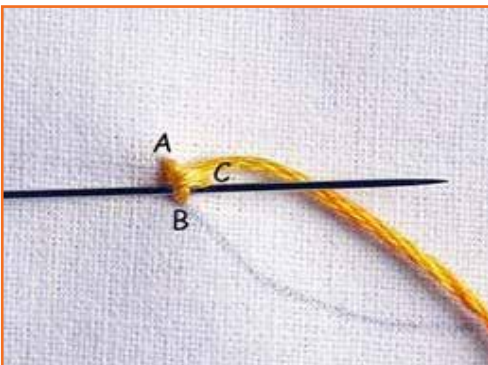

**Step 3:** Take the needle under the stitch A-B. Only, this time, the needle is angled below or towards the right side of the point C. Then, loop the thread around the needle

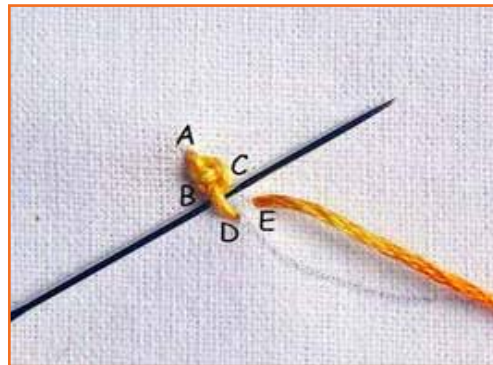

**Step 4:** When we pull out the needle, the first double knot is formed. For the next knot by putting in the needle through D on the stitch line and bringing it out from E, just above the point D. Continue with the procedure as we did for the first knot.



**Step 5:** The finished portion of double knot would look like as in figure.



### 3.3.19 Steps of Carrying out Bullion Knot

This knot is very similar to the French Knot, but here the loop is threaded around the needle more times, producing a worm of a knot that is inserted a slight distance from the needle's original entry point. Bullion knot is used to create decorative dots, leaves, plants etc.

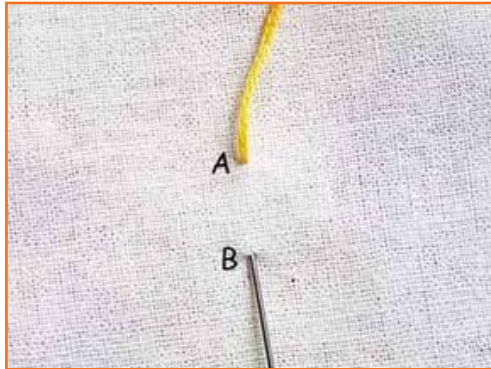

**Step 1:** Bring the needle out through A and put the needle through B at a desired length.

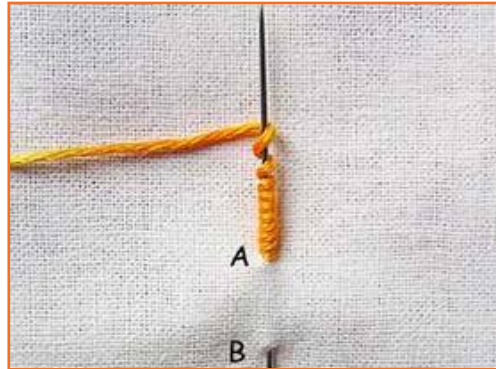

**Step 2:** Bring the needle out through A again. Then, wind the thread around the needle as shown. The distance of wound thread should measure the same as the distance between A and B. Too many or too less wraps will spoil the stitch.

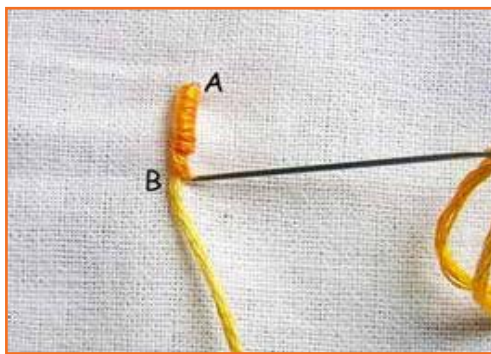

**Step 3:** Hold the wrapped thread with your fingers and pull the needle out with the other finger. Keep pulling the needle completely in an upward direction till the wraps lay on the fabric. Adjust and straighten the wraps if required and put in the needle back through B.



**Step 4:** The finished bullion stitch would look like as in the figure

### Industry Visit

The purpose of visiting a tailor shop/boutique is to get hands on knowledge about various processes involved in the work of a tailor. During the visit you have to interact with Tailors and owner of the shop to understand how work is done in a tailor shop/boutique. Make sure that you keep a notebook handy and note down any important points that come up during your interaction at the tailor shop/boutique. When you go to an tailor shop/boutique, you should:







- Understand different types of stitches such as; flat stitches, loop stitches and knotted stitches.
- Observe how a tailor carries out flat stitches, loop stitches and knotted stitches
- Ask questions to Tailors/shop owners if you have any query.



## Resources



Scan the QR codes or click on the link to watch the related videos.

Descriptions	QR Codes
Types of sewing machines	 <a href="https://youtu.be/_2ZLtGfBJrY">https://youtu.be/_2ZLtGfBJrY</a>
Parts of a sewing machine	 <a href="https://youtu.be/al_hc7DoKXk">https://youtu.be/al_hc7DoKXk</a>
Types of stitching	 <a href="https://youtu.be/NtmiZU1dkZM">https://youtu.be/NtmiZU1dkZM</a>
Sewing a pant	 <a href="https://youtu.be/Q3Y5Q_iW1Ao">https://youtu.be/Q3Y5Q_iW1Ao</a>
Attaching belt in a pant	 <a href="https://youtu.be/7Biev39gR2k">https://youtu.be/7Biev39gR2k</a>
Sewing a shirt	 <a href="https://youtu.be/g7AA-gfAKes">https://youtu.be/g7AA-gfAKes</a>

## Exercise

1. Lockstitch sewing machine also called the domestic sewing machine.
  - a) True
  - b) False
2. machine is used in reinforcing the opening and closing of pockets.
  - a) Button attachment
  - b) Bartracking
  - c) Embroidery
  - d) Button Holer
3. Thimble is a parts of a basic sewing machine?
  - a) True
  - b) False
4. Fold the bottom of right trouser leg 1 cm inside. Again fold the fabric to the required width and put 2 or 3 stitches, this is the last step of Bottom Hemming using Folder.
  - a) True
  - b) False
5. machine is used for stitching of Side seam of trousers?
  - a) Button attachment
  - b) Bartracking
  - c) Feed off the arm
  - d) Flat Lock Machine
6. Which of the followings are the steps of Pocket Making and Stitching:
  - a) Locate the notch mark
  - b) Stitch the inner side of the pocket mouth using edge stitch
  - c) Take the ready pattern given and place it over the pocket
  - d) All the above
7. Shirt pocket is commonly:
  - a) Side Pocket
  - b) Co-in Pocket
  - c) Patch Pocket
  - d) All the above
8. Which of the followings are the commonly used types of flat stitching:
  - a) Satin
  - b) Cross

- c) Stem
  - d) All the above
9. Stem stitch, and its variations, are worked as a thin line and can be used to outline embroidered shapes, stitch lines and curves, embroider letters.
- a) True
  - b) False
10. Stitch is used to secure the edges of buttonholes as it gives a much sturdier stitch due to the knots it makes.
- a) Chain
  - b) Button Hole
  - c) Fish bone
  - d) Feather
11. stitch is a type of filling stitch and is used for making leaves and feathers.
- a) Feather
  - b) Fish bone
  - c) Chain
  - d) Button Hole
12. Which of the followings are the types of loop stitch:
- a) Double Knot
  - b) Bullion Knot
  - c) French Knot
  - d) All the above
13. is also known as Palestrina knot stitch.
- a) Bullion Knot
  - b) Double Knot
  - c) French Knot
  - d) None of the above





## 4. Inspections and Alterations for Fittings

Unit 4.1 - Inspections and Alterations for Fittings



AMH/N1949

## Key Learning Outcomes

**At the end of this module, participants will be able to:**

1. Explain the importance of basic elements of garment fitting.
2. Carry out fitting inspection.
3. Recognise the common fitting errors and their solutions.



## UNIT 4.1: Inspections and Alterations for Fittings

### Unit Objectives

At the end of this unit, participants will be able to:

1. Explain the importance of basic elements of garment fitting.
2. Carry out fitting inspection.
3. Recognise the common fitting errors and their solutions.

#### 4.1.1 Basic Elements of Garment Fitting

A well-fitted garment is very important to reach the satisfaction level of a client who wears tailored attire. Every detail has to be attended to, when a tailor does fittings. If the fittings are improper the look and design of the garment completely destroyed.

A good fit is based on 5 classic elements

1. **Grain:** For a good fit the garment should be cut on the right grain. If the costume is off-grain, the seam lines may twist or hang crooked. Imprecise cutting or stitching may result in deviation in the grain line.
2. **Set:** Is when the garment fits perfectly without any undesirable wrinkles. Wrinkles usually occur because the garment is too large or too small for the customer.
3. **Line:** Refers how the lines of the garment are in alignment with the natural lines of the body. Poor design or construction can result in an out of line garment
4. **Balance:** occurs when the garment is in equilibrium. The garment should appear symmetrical, when viewed from any angle.
5. **Ease:** Is how fitted or airy the fittings of the garment is. A good fitted garment will give some room to breathe and won't be too fitted or tight.

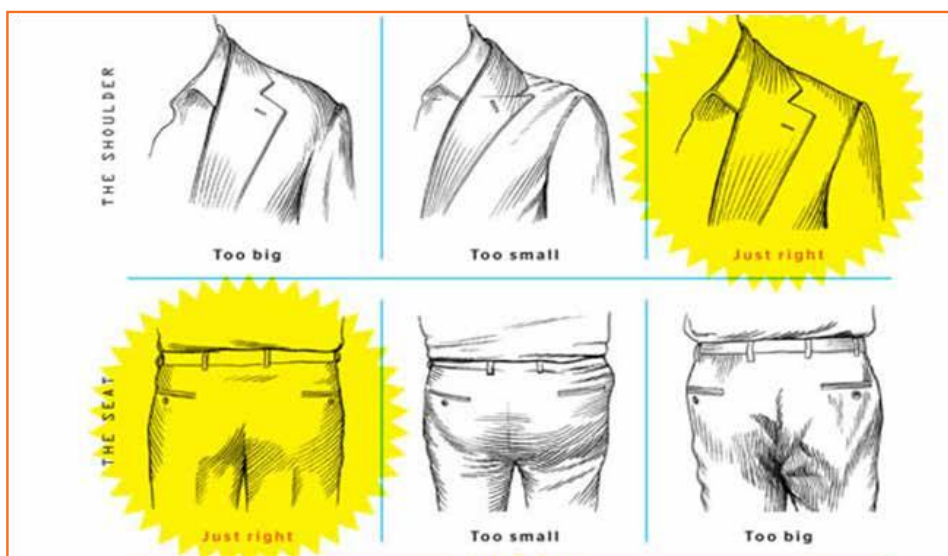

Fig.4.1.1(a): Garment Fittings

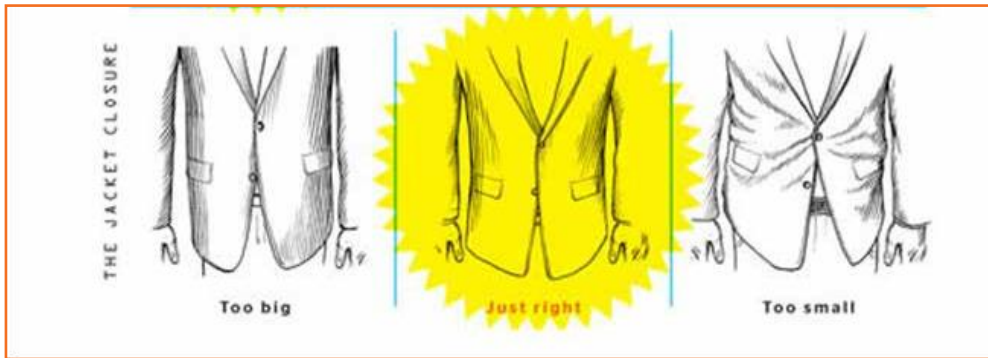

Fig.4.1.1(b): Garment Fittings

### 4.1.1.1 Carrying Out Fittings Inspection

A tailor must check the following details when he checks the fittings of a garment

#### Shoulders

- Seam should lie on the edge of the shoulder.
- The shoulders should be wide enough to ensure that the sleeves hang comfortably into position.
- The shoulder slope of the garment should go in sync with the shoulder slope of the wearer.

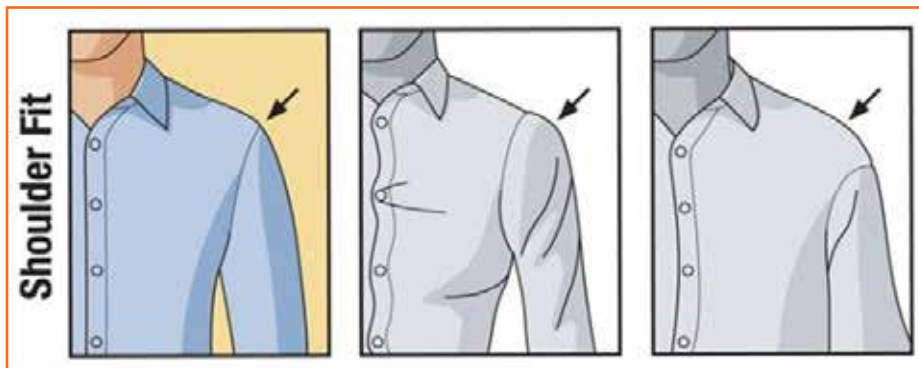

Fig.4.1.2: Shoulder Fitting

#### Chest/Bust

- The tip of the dart should end about an inch before the fullest part of the curve of the bust.
- Incorrect positioning of the dart will make the garment too fitted around the bust area.



Fig.4.1.3: Chest/bust Fitting

### Neckline

- The front of the normal neck line should be always larger than the neckline at the back
- Neckline should not be too large or too small.

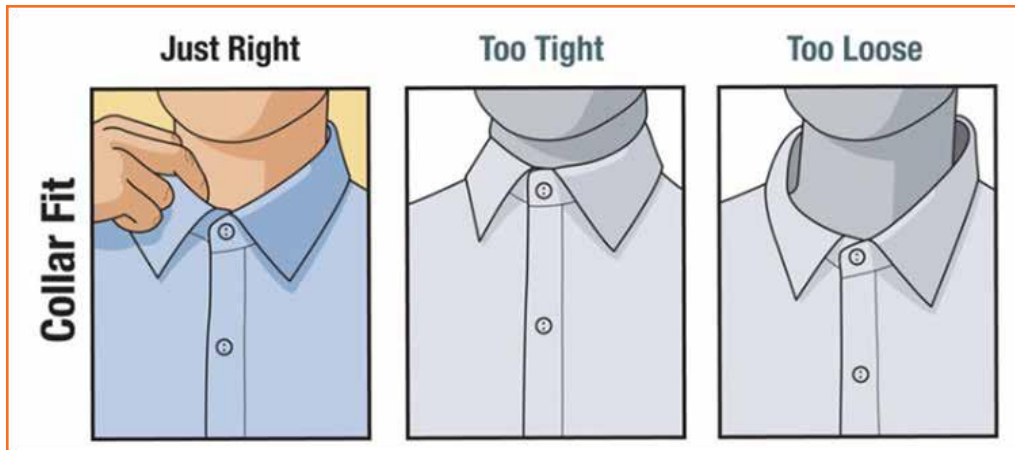

Fig.4.1.4: Neckline Fitting

### Collar

- The circumference of the collar should be at least 1/4th of an inch bigger than that of the neckline.
- You should be able to slip a finger in between your neck and the shirt at any point without struggling or forcing.
- The collar should neither be too tight nor too loose.



Fig.4.1.5: Collar Fitting

### Sleeves

- The crosswise grain at the bicep should lie parallel to the floor.
- The sleeve should not be too fitted and should hang comfortably.
- The sleeve should begin from the edge of the shoulder seam. If it is too high the sleeve would pull.

### Waistline

- The waistline should not be too fitted or too loose as both can cause discomfort.
- The narrowest part of the garment should fall at the wearer's waist.

### Hips

- Garments should have enough room around the hip area.
- Garment should not have excess ease in hip or thigh area as it will result in vertical folds.

### Crotch/seat

In order to incorporate comfort and durability, trousers and other bifurcated garments require a well-fitted crotch for. A properly tailored crotch doesn't cut or bind the wearer amid the legs and adapts to the shape of the buttocks. There should be slight ease in the crotch area. Crotch length has one inch of ease in the crotch area. The back of the crotch seam should be lengthier and more deeply curled than the anterior as the behind of the buttocks are more curved than the front. Bigger sizes require longer and deeper curved crotch lengths at the back. Oblique wrinkles radiating from the crotch area is because crotch curve isn't left long enough to allow the size of the buttocks. Diagonal wrinkles in the front may also be due to the wearer's big abdomen. Wrinkles coming upward from the crotch area indicate a too tight and high crotch, causing to chafing and discomfort. Wrinkles coming downwards from the crotch area shows a low and loose crotch; it stacks and drops, restricts walking and has increased probability of ripping from strain of movement. If the rise may be elongated or reduced, the waistband should also be raised or lowered. Rise should not be lengthened or shortened in the crotch length as the same may lead to problems where none existed.

## 4.1.2 Why and How to Fit?

To have a good fit of a garment, accurate calculations and design corrections is not enough. They can only provide an approximation of one's figure needs. The other points to be considered to have a good fit are:

1. The stylishness of the attire whether it suits oneself or not.
2. The sufficient ease in the garment.
3. The posture and the individual figure of the wearer.

Only on a fabric test fit, these can be evaluated. Since only minor changes can be made once the garment has been cut on the fabric. Hence a test fit can save lot of waste. There are times when test fit is not necessary, those are when one is sure of the style, know from experience how to adjust the pattern, have sufficient material to recut if necessary and have adequate seam allowances to borrow in crises. But if one has any doubts whatsoever, then test fitting is a must.

Usually used test material is muslin, bleached or unbleached. It should be used in a similar weight to that of the final fabric. Any other solid coloured plain weave fabric like poplin in a similar weight to final fabric would do. A plain surface is recommended as this clearly shows all seams, darts and other style details. Layout the pattern cut and mark your test fit fabric with equal amount of care as you would your final garment fabric. The fastest way to get the outcome of the finished garment without actual stitching is to overlay and pin all the seams lines. Pinning gives the same result and information, that one wants without going to the machine. It is so faster to unpin and then re-pin. After that to rip stitching and re-stitching.

Pins must be placed at the right angle to the seam line, as in, this method there is least amount of straining or pull on the seam, and it does not gape. When test-fitting trousers remember to baste stitch the crotch seam. Check the test fit muslin and make alteration till fully satisfied. Mark all the rectifications and the same should be relocated on the pattern for it is the paper pattern that one should use to cut the final fabric and not the test fit muslin. Mark new notches as the old ones may not hold good after the alterations. Check the lengths of two corresponding seams to ensure that the alterations have not created more problems, e.g. if you have corrected the dart intake of side seam dart in the front, check to ensure that both the side seams are still equal or not and if vital make the necessary changes.

### Methods of fit

There are two kinds of fitting:

4. The first test fit is done on muslin at the time when the design is made. A basic test fit is done to cross check, the pattern fitting; the pattern is cut with relevant seam allowances and pinned in place for test fitting. Make sure that seams and darts are in place. This fitting is done from the right side of the garment. These corrections become the new seam lines for the garment. Check the garment for ease and fullness. It is important to mark buttons and buttonholes at right places in this fit.
5. The second is after the garment has been stitched before final finishing. Stitch the garment with relevant interfacing/ or underlining in place press it well and test fit to check the position of darts, seams, puckers if any and find the position of outer seams. This sort of fitting improves the fit of the attire. Other times when refitting happens, if the garment has been purchased readymade from the market some alterations may be required for it to be fitted to an individual's size and also if there are changes in the body size. The methods by which each pattern seam or area is to be corrected or reformed depends on the type of problems and nature of the fitting defect. The major problem areas have been previously recognized and thoroughly explained. There are areas that require minor modifications those have been explained and those that require some pattern manipulation have been shown with figures and explained briefly.

Given below are some of the fitting problems that would necessitate pattern alterations.

### Waist alterations

- **Thick waists** reduce the size of the darts and or add at the side seam.
- **Slim waists** upsurge the size of the darts and take some at the side seam. If alteration is a small amount then the changes may be made in either in the darts or on the side seam. But in case the amount is adequately large than half of it should be altered in the dart and half in the side seam.

### Shoulder alterations

Since the clothes hang from the shoulder their correct fit begins the lines and shaping of the rest of the garment.

- **Narrow shoulders:** On front and back pattern; draw L-shaped slash lines from mid shoulder to notches on the armhole. Slash and overlap the pattern at shoulder to the needed amount. Redraw the shoulder line.
- **Square armholes:** On front and back pattern, draw slash lines from neck to armhole edges. Slash and spread the pattern at armhole edges to the needed amount. Raise the armhole curve by the correction amount. Redraw the pattern on a new sheet or add paper to fill the gap
- **Broad shoulders:** On front and back pattern draw L-shaped slash lines from mid shoulder to notches on the armhole. Slash and spread the pattern at shoulder to the needed amount. Redraw the pattern or insert paper in the gap. Correct the shoulder lines.
- **Sloping shoulders:** On front and back pattern draw slash lines from neck to armhole edges. Slash and overlap the pattern at armhole edges to the needed amount. Pin the pattern piece or scotch- tape it to the required position. Redraw the armhole curves, lowering them at underarm by the same amount that you have taken in for corrections.
- **Round armholes:** On front and back pattern, draw slash lines from neck to armhole edges. Slash and overlap the pattern at armhole edges to the needed amount. Redraw the armhole curves, lowering them at underarm by the same amount that you have taken in for corrections.

### Sleeve alterations

The sleeve hangs from the shoulder and setting of the sleeve starts at the shoulder. Check that the armhole is neither too tight nor too loose otherwise a sleeve will not set in properly.

- **Wrinkling, pulling, straining, binding:** This may be due to insufficient width across the sleeve cap, across the chest or back. Unpin the sleeve. Use some of the sleeve seam allowances at the armhole and sleeve cap for more width.
- **Tight armhole:** Drop the armhole by requisite amount. Add width at both the armhole and sleeve edge. Use some of the under arm seam allowances at sleeve and side seam.
- **Short sleeve stands out at the hem:** This is due to insufficient length of the sleeve cap. Draw a slash line across the cap. Slash and spread to the needed amount. Correct the armhole curve.
- **Sleeve cap wrinkles across the top of the sleeve:** This indicates too much length at sleeve cap. Draw a slash line across the cap. Slash and overlap to the needed amount. Correct the armhole curve.
- **Heavy arm:** Draw an upturned slash line on each side of the sleeve opening at under arm to the lower edge of the sleeve. Slash and spread the pattern to half the needed amount to each side at the underarm and tapered to nothing at the lower edge. Make identical changes in the armhole seam of the front and back bodice. Draw a slash line from the underarm to waistlines in front and back bodice. Slash and spread the pattern to the same amount as that added on each side of the sleeve, starting at the underarm and tapering to nothing at the lower edge.
- **Tight upper arm:** Slash the sleeve at the centre from shoulder point to the lower edge. Spread at the cap the essential amount tapering at the lower edge.

### Bust alterations

Since the bust area is the most difficult to fit being the rounded part of the body. Check the garment; it should be neither too tight nor too loose. Big alterations are not very effective in this area especially for closer fitting garments.

- **Bust with a large cup:** As you know, women with the same bust size have different cup sizes. These causes the garment to be tight over the bust area. Draw a upright slash line from the shoulder passing through the bust point to the other edge of the pattern, passing through the waistline dart. Draw a vertical line to this line at the bust point from centre front to the side seam. Slash on all lines and spread the pattern adding at the bust area without increasing at the shoulder. The added width at the side seam and waistline should be taken in a dart. If the dart intake is very big it is advisable to convert it into two darts.
- **Bust with a small cup:** Draw a vertical slash line from the shoulder passing through the bust point to the other edge of the pattern, passing through the waistline dart. Draw a perpendicular to this line at the bust point from centre front to the side seam. Slash on all lines and overlap the pattern without reducing on the shoulder.

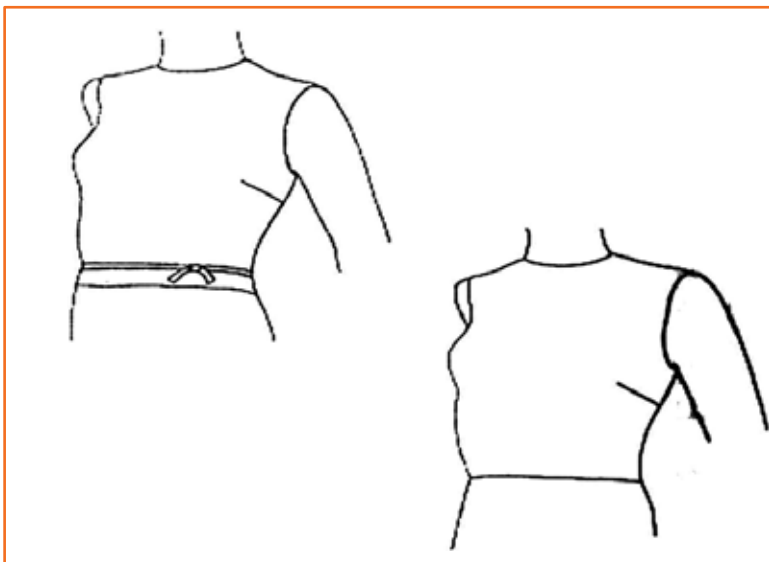

Fig.4.1.6: Bust with a large cup

### Hip pattern alterations

Fitting problems in this are manifest themselves in wrinkling, pulling, sagging and uneven hemlines.



- **Small hips:** Draw a vertical slash line from the waist to the hem of the skirt pattern. Draw a horizontal line from centre back to the side seam passing through the fullest part of the hip. Slash the pattern on both the lines and overlap width wise to remove excess without loosing at the waist, unless the dart intake can be taken out for ease. Overlap length wise to remove excess without loosing at the side seam. True the seam lines.
- **Large hips:** Draw a vertical slash line from the waist to the hem of the skirt pattern. Draw a horizontal line from centre back to the side seam passing through the fullest part of the hip. Slash the pattern on both the lines and spread width wise to fullness; the added ease may be taken in the dart intake. Spread length wise to add fullness without adding at the side seam. True the seam lines.

Given below are some of the common fitting problems that would necessitate pattern alterations with illustrated solutions by draping method.

### 1. Problem- Folds below the bust dart.

Solution- Undo the dart and part of the side seam. Lift shoulder a little, re-pin a bigger dart and pin the side seam to take out the excess fabric.

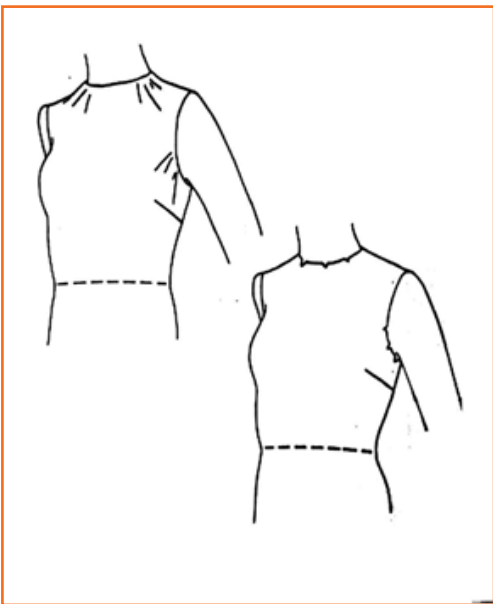

Fig.4.1.8: Low waist

### 3. Problem- Baggy below the hip.

Solution- Raise the skirt at back only and re-pin

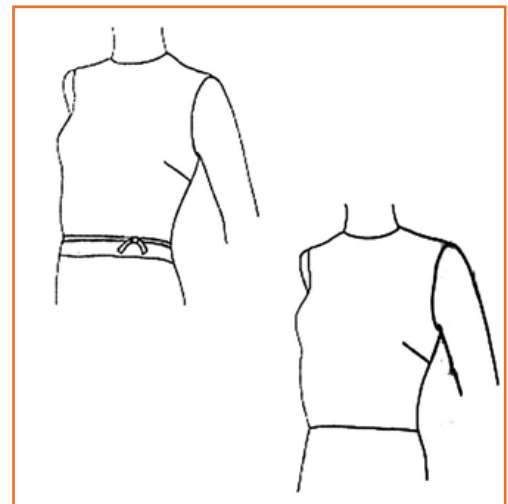

Fig.4.1.7: Folds below the bust dart

### 2. Problem- Low waist.

Solution- Tie a band around the waist and remark the waistline. Remove and re-pin the skirt to new waistline.



Fig.4.1.9: Baggy below the hip

#### 4. Problem- Gaping armhole

Solution- undo dart and pin a bigger dart. Making sure that it points towards the bust point. One may need to lift shoulder seam at the armhole.

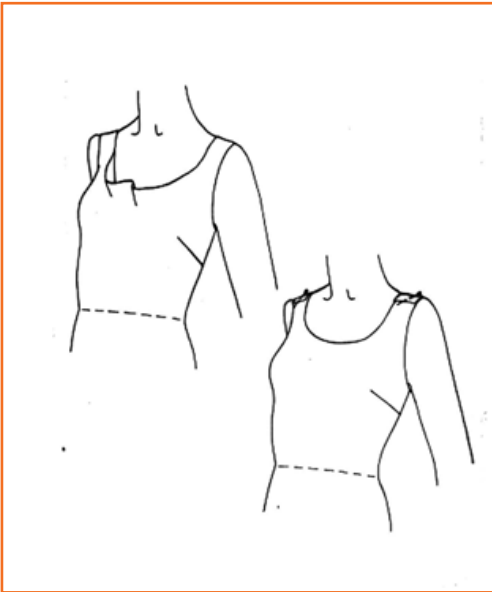

Fig.4.1.11: Low neckline gapes

#### 6. Problem- Folds in the dress below the waist.

Solution- Undo the side seam from below the armhole and ease out until the garment hangs smoothly.

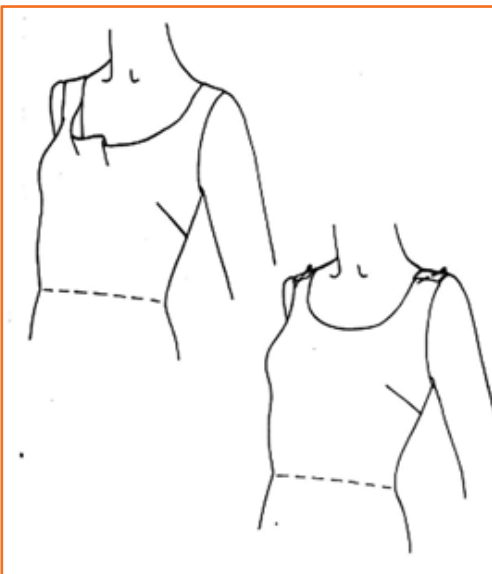

Fig.4.1.13: Tight neck or armhole

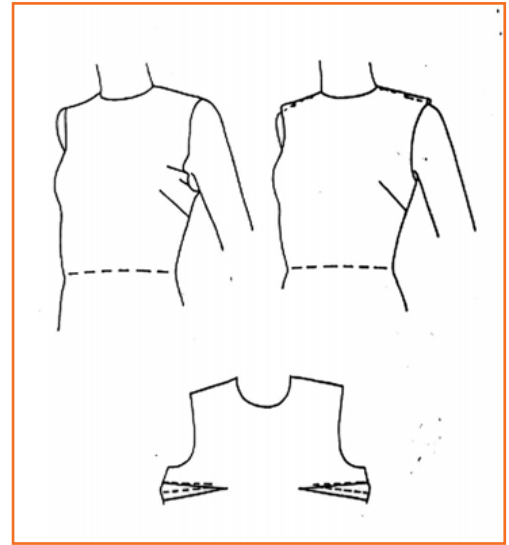

Fig.4.1.10: Gaping armhole

#### 5. Problem- Low neckline gapes.

Solution- Lift at the front shoulder seam. Lower the dart point if necessary

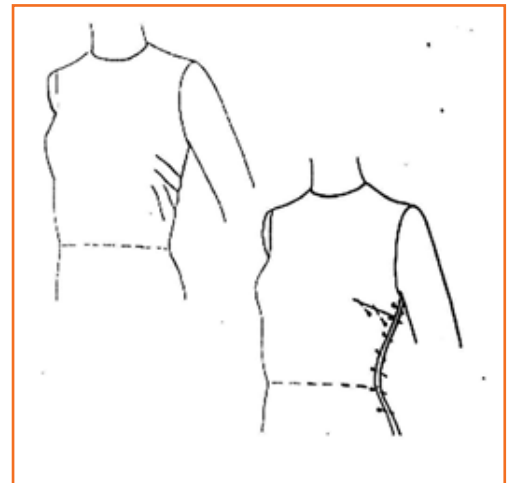

Fig.4.1.12: Folds in the dress below the waist

#### 7. Problem- Tight neck or armhole.

Solution- slash and snip seam allowance to release tension. If it is not enough, mark a new seam line that is lower than before.

**8. Problem- Neckline stands away and folds below.**

Solution- release shoulder seam and let it out at the armhole edge.

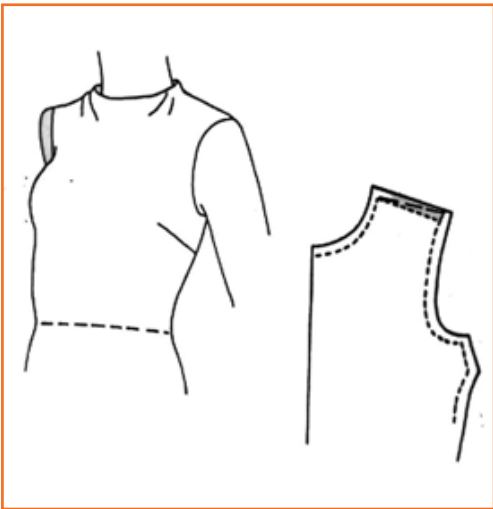

Fig.4.1.15: Shoulder seam lies towards the front of the shoulder

**10. Problem- Folds across sleeve at the top.**

Solution- Mark a new fitting line below the existing one to reduce cap height.

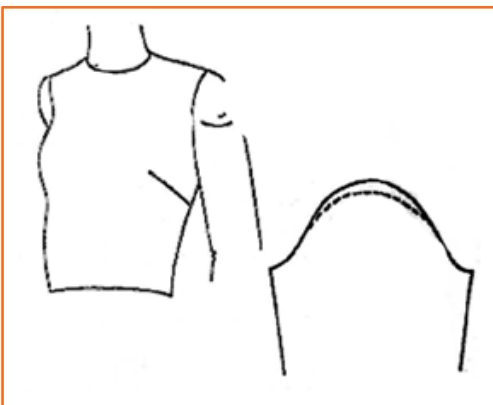

Fig.4.1.17: Sleeve hangs towards the back

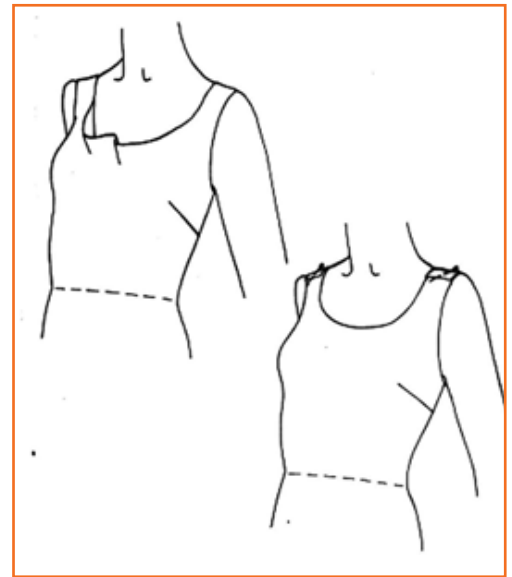

Fig.4.1.14: Neckline stands away and folds below

**9. Problem- Shoulder seam lies towards the front of the shoulder.**

Solution- Undo shoulder seam and release front seam allowances only.

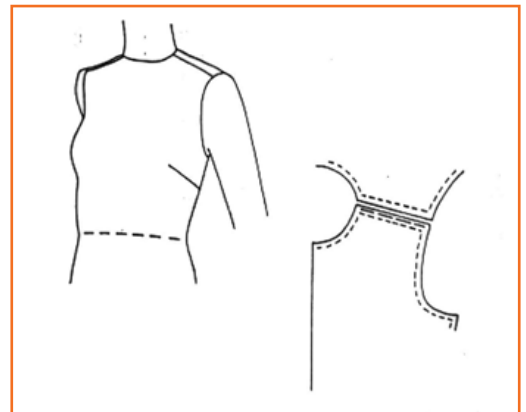

Fig.4.1.16: Folds across sleeve at the top

**11. Problem-Sleeve hangs towards the back.**

Solution- Remove the sleeve and re-pin by moving the notch at the centre of the sleeve toward the back so that the sleeve may hang towards the front

**12. Problem- Wrinkles and creases around the upper arm.**

Solution- Release the underarm seam allowance and add the ease.

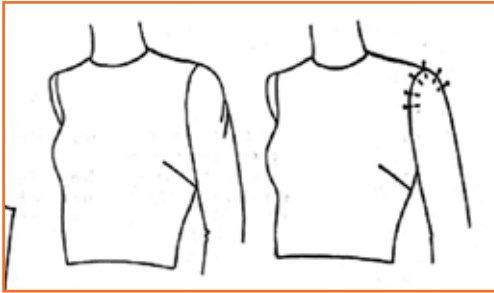

Fig.4.1.19: Sleeve pulls at the back armhole

**14. Problem- Trousers are loose at waist, hip or leg. Creases on leg and trousers stands away at waist.**

Solution- Take excess fabric at side and pin at original seam lower down. For larger hip increase the dart intake. Pin the excess towards the outer seam.



Fig.4.1.21: Trousers tight below the waist

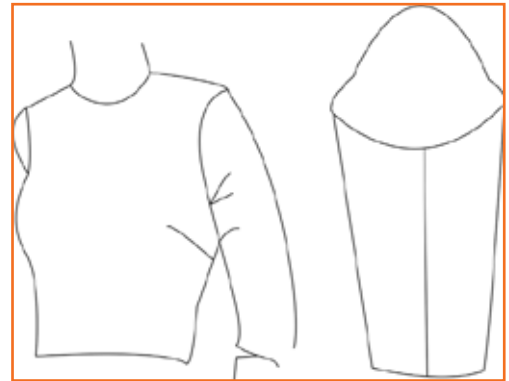

Fig.4.1.18: Wrinkles and creases around the upper arm

**13. Problem- Sleeve pulls at the back armhole.**

Solution- Unpin the sleeve and release the seam allowance on both the armholes of sleeve and bodice.



Fig.4.1.20: Loose at waist, hip or leg

**15. Problem- Trousers tight below the waist, crease around abdomen.**

Solution- Release darts and reduce their width and length, also release some ease on the outer seams and re-p"

### 4.1.3 Common Fitting Errors and Their Solutions

Most of fitting errors can be altered or changed easily.

Problems	Solutions
Folds below the bust dart	Undo the dart and part of the side seam. Lift the shoulder, re-pin a larger dart and pin the side seam to take out the excess fabric.
Gaping armhole	Undo dart and pin a bigger dart. Making sure that it points towards the bust point. Lift shoulder seam at the armhole.
Low neckline gapes.	Lift the front shoulder seam. Lower the dart point if necessary.
Folds in the dress below the waist.	Undo the side seam from below the armhole and ease out until the garment hangs smoothly.
Tight neck or armhole.	Slash and snip seam grant to release tension
Neckline stands away and folds below.	Release shoulder seam and let it out at the armhole edge
Shoulder seam lies towards the front of the shoulder.	Undo shoulder seam and release front seam allowances only.
Sleeve hangs towards the back	Remove the sleeve and re-pin by moving the notch at the centre of the sleeve toward the back so that the sleeve may hang towards the front.
Wrinkles and creases around the upper arm.	Release the underarm seam allowance and add the ease.
Sleeve pulls at the back armhole.	Unpin the sleeve and release the seam allowance on both the armholes of sleeve and bodice.
Trousers are loose at waist, hip or leg. Creases on leg and trousers stands away at waist.	Leave the darts and decrease their width and length, also release some ease on the outer seams and re-pin.
Trousers tight below the waist, crease around abdomen.	Release darts and reduce their width and length, also release some ease on the outer seams and re-pin.

Fig.4.1.22: Common Fitting Errors and Their Solutions

### Industry Visit

The purpose of visiting a tailor shop/boutique is to get hands on knowledge about various processes involved in the work of a tailor. During the visit you have to interact with Tailors and owner of the shop to understand how work is done in a tailor shop/boutique. Make sure that you keep a notebook handy and note down any important points that come up during your interaction at the tailor shop/boutique. When you go to an tailor shop/boutique, you should:

- Know the importance of basic elements of garment fitting and alteration.
- Inspect and recognise the common fitting errors and their solutions.
- Observe how a tailor carries out fitting of pant, shirt and kurta.
- Ask questions to Tailors/shop owners if you have any query.

## Resources



Scan the QR codes or click on the link to watch the related videos.

Descriptions	QR Codes
How to ALTER	 <a href="https://youtu.be/wGn1H5dCMkQ">https://youtu.be/wGn1H5dCMkQ</a>

## Exercise



1. A tailor must check the following details when he checks the fittings of a garment:
  - a) Chest
  - b) Shoulders
  - c) Collar
  - d) All the above
2. The circumference of the collar should be at least 1/4th of an inch bigger than that of the neckline.
  - a) True
  - b) False
3. Sleeve cap wrinkles across the top of the sleeve can be rectified as:
  - a) Drop the armhole by requisite amount. Add width at both the armhole and sleeve edge. Use some of the under arm seam allowances at sleeve and side seam.
  - b) This is due to insufficient length of the sleeve cap. Draw a slash line across the cap. Slash and spread to the needed amount. Correct the armhole curve.
  - c) This indicates too much length at sleeve cap. Draw a slash line across the cap. Slash and overlap to the needed amount. Correct the armhole curve.
  - d) None of the above.
4. Quality means:
  - a) Looks
  - b) Comfort
  - c) Design
  - d) Value for money
5. Common fitting errors include:
  - a) Folds below the bust dart
  - b) Gaping armhole
  - c) Low neckline gapes
  - d) All of the above





# 5. Maintain Work-Area, Tools and Machines

Unit 5.1 - Maintain Work Area, Tools and Machines



## Key Learning Outcomes

**At the end of this module, participants will be able to:**

1. Practice the machine safety and maintain machines properly.
2. Carry out basic maintenance of machine.
3. Maintain tools and equipments and handle them safely.
4. Use materials to minimize waste.
5. Carryout running maintenance within agreed schedules.
6. Carry out maintenance and/or cleaning within one's responsibility.
7. Work in a comfortable position with the correct posture.
8. Use cleaning equipment and methods appropriate for the work to be carried out.
9. Dispose of waste safely in the designated location.
10. Store cleaning equipment safely after use.
11. Carryout cleaning according to schedules and limits of responsibility.

## UNIT 5.1: Maintain Work Area, Tools and Machines

### Unit Objectives



**At the end of this unit, participants will be able to:**

1. Practice the machine safety and maintain machines properly.
2. Carry out basic maintenance of machine.
3. Maintain tools and equipments and handle them safely.
4. Use materials to minimize waste.
5. Carryout running maintenance within agreed schedules.
6. Carry out maintenance and/or cleaning within one's responsibility.
7. Work in a comfortable position with the correct posture.
8. Use cleaning equipment and methods appropriate for the work to be carried out.
9. Dispose of waste safely in the designated location.
10. Store cleaning equipment safely after use.
11. Carryout cleaning according to schedules and limits of responsibility.



*Fig 5.1.1: A well maintained machine shop*

### 5.1.1 Introduction

Machines are essential to modern production. However, along with accrued productivity, they have brought hazards into the tailoring shop. proper management of machine hazards has traditionally been seen as expensive and a constraint on productivity. In general, the garment manufacturing trade is considered to be less dangerous than alternative industrial sectors and, therefore, safety policy is a low priority in several enterprises. for example, it has been ascertained that some workers remove guards protective belts from sewing machines, and manual cutting machines are operated with naked hands.

Machine breakdown is a common reason behind production delay affecting delivery schedules. Considering the importance of meeting delivery dates, a competitive enterprise cannot afford penalties for delay due to machine breakdown therefore, proper maintenance of machines to prolong their economic life, reduce breakdowns, prevent defective outputs and guarantee safe operation ought to be additional importance. protective staff against pollution from the frequent use of solvents for cleaning and the existence of cotton or other fibers within the surroundings ought to also be taken into consideration. Maintenance and safety measures to eliminate these hazards and increase machine productivity, beside affordable techniques for environmental control, are mentioned below.

### 5.1.2 Maintain Machines Properly

A poorly maintained machine is inefficient, if not dangerous. it will also have frequent breakdowns and quality issues. proper maintenance isn't lost production time; it's an investment for higher productivity and lower repair prices. nonetheless in several corporations, machines are maintained only if they break down. this can be as a result of a number of reasons:

- Machines are owned by the contractors or they're leased.
- No maintenance personnel are available.
- No time to maintain machines is allotted under production time.
- There is a powerful belief that maintenance means cost.
- Some machines are not simple to maintain.

Machine down-time affects production and causes delays. Defects are also made inflicting quality and productivity issues. Machine maintenance ought to, therefore, be planned and coordinated with supervisors and employees. employees ought to be involved in machine maintenance and should be equipped a basic tool kit to include tweezers, small screwdriver, machine brush, oil can and material wipes. one of the basic training skills is to train employees to do routine machine maintenance such as:

- Removing lints
- Cleaning the tension assembly
- Cleaning the feed dog assembly
- Cleaning the bobbin area
- Lubricating the machine

### 5.1.2.1 Removing Lint

**Lint:** With proper care, a sewing machine can last for many, many years. Fabric and thread are a combination that is going to produce lint. Lint can build up in unseen areas of machine leading to wear and tear. To keep the sewing machine running smoothly, good quality thread should be used and simple maintenance should be performed regularly. One of the most important things is to clean out the pieces of lint leftover from bits of thread and fuzzy fabric. Sewing with thick, furry fabrics (such as polar fleece), will need cleaning of the sewing machine frequently. One should open all areas that can be cleaned and clean the lint out of the machine. Usage of brush should be done to remove lint in cracks and crevices and from under the bobbin case.

#### Requirements: Sewing machine

- Lint brush
- Small soft brush
- Clean lint free cloth
- Compressed air (optional but helpful)
- Light source
- Screw drivers

### 5.1.2.2 Cleaning the Bobbin Area

- **Step 1:** Turn off and unplug the sewing machine.
- **Step 2:** Remove the bobbin cover and the bobbin.
- **Step 3:** Using a small lint brush (many machines come with one), carefully remove any lint from the bobbin area. Be especially sure to remove any lint from crevices and tight places, since compacted lint can actually stop the machine from running.
- **Step 4:** Using the lint brush or canned air, remove the lint from the area around the needle, the presser foot and the thread guides.
- **Step 5:** Remove any lint from the inside of the doors and lids of the sewing machine.
- **Step 6:** Replace the bobbin and the bobbin cover.
- **Step 7:** Plug the sewing machine back in and turn it on.

**Note:** Make sure to check that after cleaning all the machine parts are properly placed and tightened. It should be safe for using it the next time.



Fig 5.1.2: Cleaning the bobbin and case

### 5.1.2.3 Cleaning the Tension Assembly

Maintaining the machine is important to keep it in good condition and to avoid unnecessary service costs. Keeping the tension assembly clean is one of the maintenance procedures that, if performed on a regular basis, can help ensure that your stitching is accurate and precise. The following steps assist the cleaning of the sewing machine tension assembly.

- **Step 1:** Clean your machine often. Each stitch is precise and even a bit of lint collected on the tension assembly can cause problems. Make it a habit to clean your sewing machine after any large project.
- **Step 2:** Raise the pressure foot to release the tension on the disks. Gently run the folded edge of a clean piece of lint free cloth through the tension disks. Compressed air will also dislodge any bits of thread or lint.
- **Step 3:** Remove all lint along the thread guides using a small brush or clean cloth.
- **Step 4:** Check the bobbin area of the machine. The bobbin controls the lower tension and can be a source of built up lint. Depending on the type of machine you have, the bobbin consists of the bobbin, case and on some models a removable hook race. Remove these according to your instruction manual and clean with a cloth or small brush.
- **Step 5:** Do a final check to make sure the tension is correct and that the bobbin assembly is in place properly before you begin your next project.

### 5.1.2.4 Cleaning the Feed Dog Assembly

The feed dogs on a sewing machine help move the fabric underneath the needle. If they're not operating properly, damage to the machine or fabric can occur. Feed dog assembly maintenance is essential to smart sewing. Use the steps below to guide you through the procedure.

- **Step 1:** Unplug the machine and examine the feed dogs. The newer machines have metal feed dogs, however older models could have rubber ones, which regularly need replacement. Examine the feed dogs and check for damage.
- **Step 2:** remove the throat plate, which is the covering over the feed dogs, and clean it with a soft fabric. Use a small soft brush to wash the feed dogs. ensure to get rid of all lint and thread from the grooves of the teeth. Some machines have an adjustment that lowers the feed dogs for specific sewing procedures. they must be in the raised position for better viewing during the cleanup method.
- **Step 3:** Clean the area around the feed dogs with a soft brush. compressed gas could be a sensible choice to use in the small tight areas.
- **Step 4:** Wipe down all areas with a clean, lint free fabric before replacing the throat plate.
- **Step 5:** Prepare to clean the feed dogs and all other areas that lint could accumulate on, after each project. Your sewing machine will last longer and need fewer repairs if kept clean and lint free.

### 5.1.3 Lubricating the Machine

In order to make sure that your sewing machine enjoys the long life it was engineered for, it is important to repairs it regularly using proper maintenance techniques. one of the best things you can do to keep your sewing machine running smoothly is to lubricate it using sewing machine oil. sewing machine oil isn't something you borrow from the garage. it is clear white oil. make sure to use the right oil. refer to your owner's manual for the right spots to oil. some of the older machines have these areas marked.



After oiling your machine run stitches on some scrap cloth before you tackle your project. this enables oil to escape on to the scraps, if it's going to, rather than the project you're working on. Oiling the machine not only lubricates your moving elements, to prevent wear, it reduces the chance of rust. Rust forms rapidly with any moistness, even just the humid ness in the air. Surface rust will act just like loose sand grain in your machine, and make excess wear.

- **Step 1:** Purchase a high-quality brand of sewing machine oil from a sewing store or other specialty merchandiser. Higher quality typically comes with a higher price tag, however the value of good sewing machine oil is favorable to the prices involved repairing or replacement an entire sewing machine.
- **Step 2:** unplug your sewing machine. check that its power switch is set to 'off.' as a result of you will be dealing with fluid, it is especially important to make absolutely certain any power supply is disconnected.
- **Step 3:** Drop a single drip of sewing machine oil onto the mechanism that drives the sewing needle. If you bought quality sewing machine oil, more than one drop can usually not be necessary.
- **Step 4:** Repeat Step three, applying one drop of oil to each part of your sewing machine that moves. Consult your sewing machine owner's manual if you would like instruction on the way to access any moving parts which will be contained beneath the casing of the machine.
- **Step 5:** allow the oil to absorb by letting your sewing machine stand for a few minutes. Most experts counsel that fifteen to half-hour could be a sensible window of time to let your machine stand while the stitching machine oil works its magic.
- **Step 6:** Plug your sewing machine back in. once you have safely done so, turn the power switch to 'on.'
- **Step 7:** Feed some scrap fabric through the sewing machine, running its moving elements at a slow but constant rate. this may allow the oil to spread equally throughout the parts that need lubrication to maintain best performance.

#### Tips & Warnings

- Never lubricate any electrical part of your sewing machine. This may damage to your sewing machine, and could result in an electric shock.

### 5.1.4 Machine Guards

There are different safety guards given in the sewing machine that are vital to use and it's also essential to check that the right safety guard is in place as per the need. Below are given the machine guards of a sewing machine.

- **Finger guard:** while guiding the fabric under the presser foot the fingers may accidentally cross into the path of the needle. Hence, finger guard is attached to the presser foot to avoid such accidents. This is very important safety feature.
- **Belt guard:** Belt guard is a cover attached to the belt pulley assembly and the ad wheel. In industrial sewing machines the pulley and the belt move at very high speeds. Hence there is always a risk of hand or hair getting caught in the belt pulley therefore it is important to have a belt guard as it protects the operator from such accidents.



Fig 5.1.3: Finger Guard

- **Eye guard:** Eye guard is important in cases where the operator is working on the fabric which has many fibers, hence eye guard protect eyes from getting tired. It also helps in protecting them against any little cloth fabric like that of wool or dust fibers. Eye guard is also used as a protection against needle-breakage in high speed sewing machines.
- **Motor pulley guard:** Motor pulley guard is attached to the motor under the Fig, like the belt guard, motor pulley guard protects our body Parts from getting caught in the wheel and belt attached to the motor below the Fig.



Fig 5.1.4: Eye Guard

### 5.1.5 Troubleshoot Common Machine

In several cases machine issues are due to the employee not having received correct training in basic machine maintenance. This causes issues that need to be corrected by a certified mechanic/technician. All garment enterprises suffer from such issues to varying degrees. Some common causes are:

- Incorrect needles
- Incorrect machine settings for the fabric
- Inexperienced staff
- Inexperienced mechanics/technicians
- Fabric finishes.

On-the-job training sessions could also be organized for beginners as part of their training period. Enlist the assistance of senior operators with teaching skills. group work will provide good opportunities for these training sessions. Sessions ought to embrace acquiring the essential sewing skills and troubleshooting sewing issues.

### 5.1.6 Carry out Basic Maintenance of Machine

It is important to carryout basic maintenance of own machine and surroundings. While operating a sewing machine we can keep a check of these two maintenances by keeping an eye on the needle point i.e.

- Must check the needle point and stitch quality while working. Be attentive and look for any kind of oil leakage is found, replace (or inform) immediately. For hazard free environment always keep the hook area clean and tidy.
- **Routine Maintenance:** This covers sub kinds of maintenance i.e.
  - » **Daily maintenance of the machinery:** While carrying out the daily maintenance one must look for whether the machine and its area is clean, look for threading of the machine, quality and quantity of the oil.

Make sure to switch off the machines after operation this is one of the most important part of daily maintenance. Keep a check on needle tip and needle bend it should not be dull or rusty at all.

- » **Weekly maintenance:** Consists of checking up the oil level and oil color in the machine. Make sure to remove the presser foot, throat plate and the feed dog too and clean them all thoroughly. Hook timing and clearance is also adjusted weekly so that the machine can work efficiently.
- » **Monthly maintenance:** While keeping an eye on monthly maintenance of the machinery it is very important check oil flow in the pipeline, refill the oil up to its maximum level for efficient and flawless performance.

## Industry Visit

The purpose of visiting a tailor shop/boutique is to get hands on knowledge about various processes involved in the work of a tailor. During the visit you have to interact with Tailors and owner of the shop to understand how work is done in a tailor shop/boutique. Make sure that you keep a notebook handy and note down any important points that come up during your interaction at the tailor shop/boutique. When you go to an tailor shop/boutique, you should:

- Understand the machine safety and maintenance rules of industry.
- Analyze how packers:
  - » Maintain machines properly.
  - » Carry out basic maintenance of machine.
  - » Maintain tools and equipments and handle them safely and use materials to minimize waste.
  - » Work in a comfortable position with the correct posture.
  - » Dispose of waste safely in the designated location.
  - » Store cleaning equipment safely after use.
- Ask questions to Tailors/shop owners if you have any query.

## Resources



Scan the QR codes or click on the link to watch the related videos.

Descriptions	QR Codes
Maintenance of single needle sewing machine	 <a href="https://youtu.be/6iE2DT6LVpg">https://youtu.be/6iE2DT6LVpg</a>



## 6. Maintain Health, Safety and Security in Tailoring Shop



Unit 6.1 - Maintain Health, Safety and Security in Tailoring Shop

Unit 6.2 - First Aid and CPR

Unit 6.2 - Sensitivity towards People with disability and Gender Equality



## Key Learning Outcomes

**At the end of this module, participants will be able to:**

1. Comply with health and safety related instructions applicable to the tailoring shop.
2. Follow environment management system related procedures.
3. Store materials and equipment in line with manufacturer's and organizational requirements.
4. Safely handle and move waste and debris.
5. Minimize health and safety risks to self and others due to own actions.
6. Monitor the tailoring shop and work processes for potential risks and threats.
7. Participate in mock drills/ evacuation procedures organized at the tailoring shop.
8. Undertake first aid, fire-fighting and emergency response training, if asked to do so.
9. Take action based on instructions in the event of fire.
10. Identify different methods of first aid.
11. Perform first aid.
12. Understand CPR.
13. Perform CPR in case of emergency.



## UNIT 6.1: Maintaining Health, Safety and Security in Tailoring Shop

### Unit Objectives

At the end of this unit, participants will be able to:

1. Comply with health and safety related instructions applicable to the tailoring shop.
2. Follow environment management system related procedures.
3. Store materials and equipment in line with manufacturer's and organizational requirements.
4. Safely handle and move waste and debris.
5. Minimize health and safety risks to self and others due to own actions.
6. Monitor the tailoring shop and work processes for potential risks and threats.
7. Participate in mock drills/ evacuation procedures organized at the tailoring shop.
8. Undertake first aid, fire-fighting and emergency response training, if asked to do so.
9. Take action based on instructions in the event of fire.

### 6.1.1 Introduction

Features in garment industry that could be improved to prevent injuries include; communication, involvement of employees in decision making, education and training of employees and management on prevention strategies, and the ergonomic conditions at the plant.

The clothing industry is usually considered as a safe place to work. Compared to other industries, there are fewer serious risks in clothing factories. The hazards in clothing industry are different from others. The major health risks in this industry come from more subtle hazards whose effect build up over time.

Tailor face a substantially higher risk of muscle pain and injury than workers in other jobs. Studies also show that frequency of

neck and shoulder injuries increases with years of employment. Tailor experience a number of cases of strain injuries. These injuries have a long-term effect on workers' health.

The physical requirements of a job are an important risk factor related to muscle pain and injury. The risks for Tailor have been linked to conditions such as improper work area design, including sitting arrangements.

Factors like repeated motions, force, body-posture are associated with higher risks and rate of injury. There are other factors are linked to injuries. Some of these factors include improper height of work pace, excessive workload, lack of support from co-worker, overall work environment etc. The factors that lead to reduction in injury rates include empowering workforce, following safety protocol, good housekeeping practices and increased support from top management.

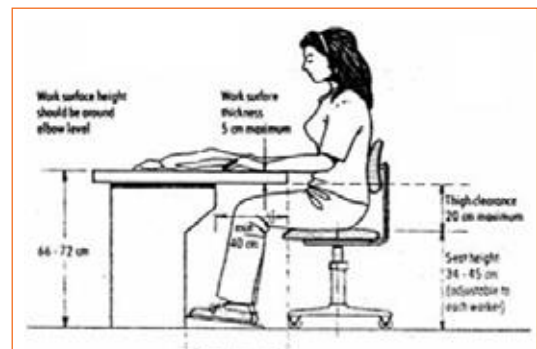

Fig 6.1.1: Body Posture

## 6.1.2 The 'Ergonomics'

Ergonomically-designed job ensures that an employee who is tall is given a comfortably enough space in or near his/her workspace so that the work efficiency is not hindered. Similarly, an employee who is shorter is able to reach all of his or her tools and products without upsetting comfort and safe assortment.

Workers are usually compelled to work in the confinement of the job or workstation that previously was designed with no dynamism or change when they are hired. This leads the workforce to work in difficult postures and positions, all of which may result in work-related injuries/disorders.

The work-place related injuries often start as minor aches and pains but can develop into incapacitating injuries that affect everyday activities. Ergonomics aims at preventing injuries by monitoring the risk factors such as force, repetition, posture and vibration that can cause injuries to develop.

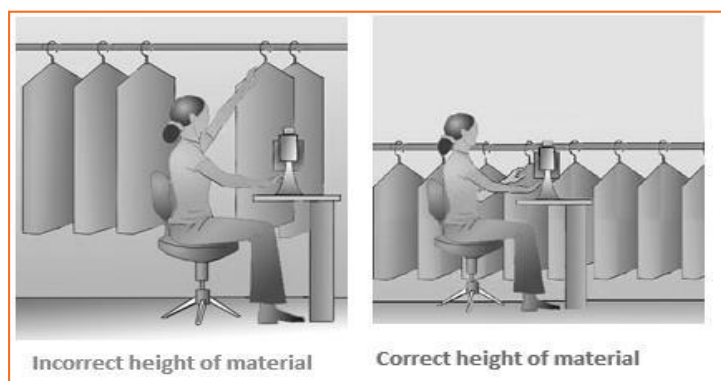

Fig 6.1.2: Situating the material

### Injuries and illnesses among textile and apparel workers

- 81% complained CTDs to the wrist.
- 70% of Tailor complains of back pain.
- 49% of workers is suffering from neck pains.
- 35% report obstinate lower back pain.
- 25% have suffered a compensable increasing trauma disorder
- 14% reported CTDs to the elbow.
- 5% reported CTDs to the shoulder.
- Absenteeism increases as working conditions worsens.
- High employee turnover is associated with detrimental working conditions.
- Embroidery tasks are associated with pain in the shoulders, wrists, and hands.
- Ironing by hand is associated with elbow pain.
- Fitting fabric in frames like of work, are associated with CTDs of the hands and wrists.

Some fundamental ergonomic principals that should be followed in our tailoring shops are:

- **Proper tools:** Tools and equipment provided at work place should be appropriate for the specific tasks being performed. The apparatus should allow the workers to keep their hands and wrists straight – the position they would be in if they were droopy relaxed at your side. The workers should bend the tool– not the wrist.

The tool should fit easily into the hand. If the grip size is too large or too small, it will be uncomfortable and will increase the risk of injury. Tools should not have sharp edges .

- **Keep repetitive motions to a minimum:** Workstations can be restructured to avoid the number of health hazards which chances due to repetitive motions that must be performed. Using a power-driven screwdriver or tools with a notch device can decrease the number of twisting motions with the arm. Work stations should have enough space for the given tasks and provide proper chairs. For deterrence of ergonomic injuries, the labour force should be encouraged to change work and take frequent but short breaks. Some tasks can be mechanical or reformatted to eliminate musculoskeletal injuries. Manufacturing tools and equipment should integrated ergonomic design codes and should not require an extreme amount of force to operate.
- **Avoid awkward postures:** The industry is such that the work force’s job should not require you to work with your hands above shoulder height on a regular basis. Arms should be closer to the body and not raised too high. Bending of their wrists, back and neck should be avoided.
- **Use safe lifting procedures:** The employee should avoid lifting objects that are too heavy. Use more than one person or a mechanical device to reduce the load. The workstation should not require lifting objects above the head or twisting his/her back while lifting. One must keep the load close to his body. Heavy and often lifted objects should be kept between knee and shoulder height and not on the floor or above the head level.
- **Get proper rest:** It is imperative to take frequent breaks to rejuvenate the body and mind so that they don’t get injured. The workforce should be groomed to understand that they should take a break from the work not just mentally but physically too. If a person has errand which doesn’t allow him to sit, he must take intervals from his work to relax his leg muscles. If he is doing a sitting job, he ust go for a walk whenever his work permits.

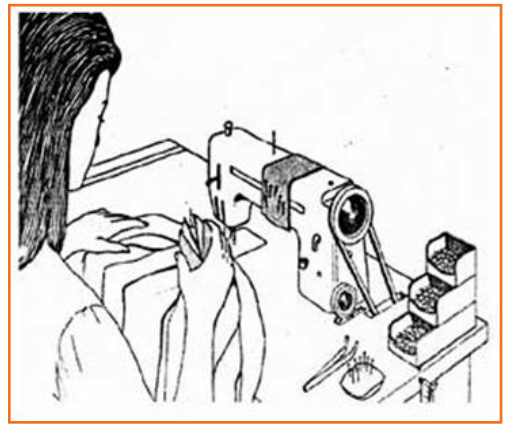

Fig 6.1.3: Cleaning the Tools

For example, if you stand all day, while performing your job you should sit down to rest your legs and feet during your breaks. If you sit down, when working you should stand up and walk around during your breaks to give your back a rest and to increase circulation in your legs. By doing this the musculoskeletal injuries can be prevented.

- **Other things to consider:** Chemicals also have a part in garment manufacturing. Dyes, enzymes, solvents and other chemicals are used to create different fabric finishes and provide durability to the product. Proper ventilation and personal protective equipment are important for protection of workers engaged in chemical processing. Similarly, for workers who handle the finished material and may be exposed to excess chemicals and off-gassing, protective equipment should be used.



Fig 6.1.4: Don'ts (a)



Fig 6.1.4: Don'ts (b)

### 6.1.3 Environmental Control Measures

Hazardous substances in one form or another can be found in almost all small and medium-sized enterprises. The garments industry generates a lot of dust from fabrics being cut and sewn. Some fabrics release chemicals which saturate the air causing difficulties in breathing and eye irritation. Solvents used for cleaning fabrics and garments may cause fatigue, headache and dizziness. Dust and solvents, when breathed, can lead to lung diseases and are very dangerous. Not only will this affect the well-being of your workers, it will also result in a reduction of productivity and product quality, increased absenteeism and turnover of staff. High levels of dust interfere with efficient production and require cleaning operations that may spoil materials and finished products. Improved conditions usually mean increased output, higher productivity and quality. There are simple and inexpensive ways to control most of the environmental problems. Improvements often result in cost savings, productivity benefits and increased safety of workers. The following rules provide a series of low-cost measures for sound environmental control.

#### 6.1.3.1 Clean Regularly and Properly - Don't Spread Dust

Dust originates from fabrics and threads, from cutting and sewing to packing operations. Thus, it is very common to see small clothing enterprises with ceilings and walls full of dusty cobwebs. Even machines which are not regularly cleaned could be full of dust which may cause them to break down.

Dust increases wear and tear on machinery, necessitating more maintenance. It also negatively affects the quality of raw materials and finished products. Dust entering the respiratory system can damage the worker's lungs. Some dust can also cause allergies. Dust should be removed regularly and eliminated from the source. More comprehensive cleaning should be carried out as often as necessary. This cleaning should also include walls, ceilings, storage racks and other areas where dust accumulates. Dust on windows, walls and lamps will significantly reduce the lighting in the tailoring shop.

#### 6.1.4 Make Local Ventilation Cost-effective

Local ventilation should only be considered as a means of reducing chemical hazards when other means have failed. There are cost-effective ways of improving ventilation.

##### Use proper fans

Apart from those used for ventilating workstations, fans may be utilized to remove dangerous substances from the tailoring shop. Contaminated air can be pushed or blown outside by having more open windows. A few points should be considered:

- There should be no obstacles between the fan and opening. Anything in the way significantly reduces the desired effect.
- The air speed should be low to reduce turbulence. In the garment industry, different fans are used; some use industrial fans or wall fans as shown in Fig. There are advantages and disadvantages for these types of fans. Industrial fans are so powerful that workers near them may be affected. Ceiling fans of the rotary type may lift the cloth being sewn, hence speed should be controlled.
- Contaminated air should not be blown in the direction of other workers on the way to the opening.
- Care should be taken that air expelled from the tailoring shop does not affect people outside the enterprise.

### 6.1.5 Good Lighting for Quality Products

Good lighting does not mean more light bulbs and more use of electricity. Natural lighting is usually a better option than the bulbs. But if there is a difficulty in arranging for a natural lighting through windows and ventilators, its important that the bulbs and other elements of artificial lights should be well-maintained. A good lighting arrangement is directly proportionate to an efficient workforce.

80% of the absorption of information from our surroundings are from our eye as a sense organ. Bad lighting means wrong or lesser absorption of information, leading to lower productivity. Eye strain in low light can lead to head ache and again decreases the productivity level of the worker.

It is imperative to understand the ways in which we can arrange for a good lighting without increasing the electricity bills. First of all one has to identify if at all you need to work upon the existing brightness level in the work place. Lighting requirements are reliant on three main features:

- The environment of the working area
- The nature of the task
- The sharpness of the worker's eyesight

A sewer needs focused light at needle point, so needle lights should always be fitted. A worker packing garments requires more largely lighting. In many situations, packers work on special tiered work tops, where lights are built into the station. The age group of the workforce is also important factor to determine this. Which means, an older worker may need twice as much light as a younger one. Another way to identify the gap, in lighting problem is going around the tailoring shop, observing the workers and asking them about their visual problems. The plan of improvements may not have much impact if the workers' eyesight is insufficient.

### 6.1.6 Reporting an Accident and an Incident

Your responsibility requires you to be aware of potential hazards and correct reporting processes. If you notice a potentially hazardous situation, eg: a client expressing violent behavior, it is important that you report it immediately to management and fill out the appropriate forms as legally required of you.

If you are injured at work you must:

- Report the injury to management as soon as possible, and certainly within 24hours.
- Seek proper treatment for your injury.

Always work in a safe manner to prevent accidents from occurring in the first place. Make sure that you have been given adequate information and on-the-job training about the first aid facilities and services available in your tailoring shop, including:

- Where to find first aid kits.
- Location of first aid rooms.
- Complete, up-to-date contact details of trained first aid officers in the tailoring shop procedures for critical accidents – such as who should be responsible for calling.
- The ambulance/doctor/nurse and what is the best method of contact, measures for evacuation of the injured person/s.
- Emergency procedure for the elimination of life-threatening chemicals commonly used in the tailoring shop.
- Universal precautions for the control of infection.
- Who to contact for debriefing/psychological support.

Always report an accident to management immediately. There should be a form at each tailoring shop that you (or the person involved) and any witnesses can fill out, where possible, otherwise. The form should cover the following areas:

- **Description of the occurrence:** What was the event that occurred, which required this report to be completed?
- **Nature of injury or disease:** Select the most appropriate description from a range of options. What injury or disease happened as a result of the occurrence?
- **First aid, medical treatment or hospital admission:** This section asks for a description of what was done to treat the injury or disease.
- **Part of the body affected:** Tick off which part or parts of the body were affected as a result of the occurrence.
- **Source of injury:** What actually caused the person to be injured or acquire a disease? This could be a piece of machinery or other hazardous materials for example.
- **Probable cause or causes of injury:** How was the source listed above actually responsible for the injury?
- **Investigation:** This asks a series of questions that seek to find out why the person has been injured or has acquired a disease.
- **Notification checklist:** This checklist makes sure that everyone who should have been contacted regarding the matter has been contacted and asks whether appropriate action has been taken by the authorities.
- **Preventative action:** This asks whether or not any action has been taken to prevent the occurrence from happening again.
- **Witness details:** This part is to be filled out if someone saw the occurrence happen. It is essential if any sort of legal action is to be taken.

### 6.1.7 Mock Drills/ Evacuations

Fire safety and evacuation plans sketch staff duties and accountabilities in time of emergency. Continuing training is required to help safeguard that the employees are conscious of those duties and responsibilities. Fire fighting trainings serve as an prospect for staff members to validate, under replicated fire conditions, that they can perform those duties and responsibilities safely and efficiently. It's also a time for them to demonstration that they are aware of defend-in-place strategies and can take advantage of your facility's fire protection features and exit facilities to protect the people in their care.

Fire drills are excellent exercise designed to evaluate staff response to a replicated emergency. They are also a test of your facility's fire safety/evacuation strategies and staff training programs. It is not essential that all fire drills run smoothly. That's okay, so long as staff and the organization learns from them and correct mistakes made. It's vital, therefore, that there be a analysis of each drill so that any problems met can be addressed. Perhaps the problems are due to unfinished or out-dated fire safety/emigration plans. Perhaps there's a need for additional staff training.

The two essential components of a fire preparedness plan are the following:

1. An emergency action plan, which details what to do when a fire occurs.
2. A fire prevention plan, which describes what to do to prevent a fire from occurring.



Fig 6.1.5: Fire Safety



## 6.1.8 Low-cost Work-related Welfare Facilities and Benefits

Work-related welfare conveniences and facilities are never given heed to. Who cares about toilets, first-aid kits, lunch rooms or lockers? What do they have to do with the hard authenticities of production? One answer is that workforces care. During each working day, workers need to drink water or some other beverage, eat meals and snacks, wash their hands, visit a lavatory, and rest to recover from fatigue. This can be difficult or easy, unpleasant or comfortable, a health risk or an aid to hygiene and nutrition. The essential facilities in the factory show if you care about employees more or the machines.

Another good reason is that extra efforts for better facilities are often appreciated far beyond the time and money capitalized, Work-related facilities benefit workers to overcome problems which are important to them. Let workers express their priorities for improvements and give their feedback . You may be surprised at the results. Giving a hygienic and wel-maintained tailoring shop is indirectly showing yur employees how much you care for them.

A small enterprise can be a community where workers are loyal, with good industrial relations and high morale, It can also be a place where workers look for the first chance to leave and care little about the owner's success. Which kind of initiative do you want? The series of low-cost facilities that trails will help to retain the best staffs.

### 6.1.8.1 Make Sure Essential Facilities Serve Their Purpose

#### Drinking water

Drinking water vessels should be made from materials that can easily be cleaned, Even if the vessels are filled with fresh water, the water inside, if kept for even a short time, can become unhygienic. It should therefore be different frequently. They should not be left uncovered, under the sun or in a hot place. Drinking fountains for production areas are very advantageous from a hygienic point of view . They can be fitted with a jet or bubbler outlet and/or goose-neck or other outlet for filling drinking cups. The fountain should be free from sharp angles and designed to prevent unnecessary splashing. Water outlets should be above the rim of overflow level so that they will not be contaminated with waste water. The water outlet should be shielded to prevent the lips of a drinker from being placed on it. Drinking water containers should be attended by a designated person. Containers should be made of impermeable materials. Containers should be provided with suitable covers, and kept in a cool place protected from the sun. The water must be changed frequently.

### 6.1.8.2 Sanitary Facilities

To avoid the possible spread of infection, it is better to use throwaway cups or to provide separate cups for each worker and to arrange for regular washing. There are several reasons why the provision of washing facilities is important:

- Dirt and grime can be ingested and cause sickness or disease; they are, in any case, unpleasant and demoralizing.
- Washing is a necessity when women have their monthly periods.
- Washing is required for basic hygiene after using the toilet.
- Apart from the obvious basic need, sanitary facilities are required by law. Clienteles often create an impression of an enterprise through the quality of its sanitary facilities.
- There should be a sufficient number of hygienic facilities on the work locations and each should be conveniently located to avoid long walks, waiting and hindrance. The law of the country must be monitored, but the following are the minimum requirements:

- One restroom is required for up to five men; two toilets for six to 40 men.
- One separate restroom for up to five women and two toilets for six to 30 women.
- One wash-basin for every 15 workers.

Ideally, there would be a separate toilet for men and women. These should be characterized as follows:

- The toilet bowl must be free from stain or odour and function properly.
- The walls of the toilet must be clean and tiles unstained.
- The ceiling of the toilet must be free from cobwebs and dust.
- Floors must be clean and safe (no broken tiles, nor slippery surface).
- Proper illumination must be provided inside the toilet.
- Toilets must have a continuous supply of water; in case water is limited in the area, water should be stocked in containers and refilled regularly.
- Mirrors and rubbish bins should be provided in the washroom.
- Soap and toilet paper should be provided.
- The washroom should provide complete privacy to users and should be fully ventilated.



Fig 6.1.6: Signages

## 6.1.7 Safety Signs at the Shop Floor

### Health and safety signs

A sign informs and instructs about safety and health at work by means of a signboard, a colour, an illuminated sign or acoustic signal, a voice or hand signal. Some important signs which could be used at a shop are as below:



Fig.6.1.7: Mandatory Signs

## UNIT 6.2: First Aid and CPR

### Unit Objectives

At the end of this unit, participants will be able to:

1. Identify different methods of first aid.
2. Perform first aid.
3. Understand CPR.
4. Perform CPR in case of emergency.

### 6.2.1 First Aid

First aid is the help given to any individual suffering from an unforeseen illness or injury, with care provided to preserve life, stop the condition from worsening, and/or promote recovery. It includes initial intervention during a serious condition before skilled medical help being accessible, like performing CPR while waiting for the ambulance, also because the complete treatment of minor conditions, such as applying a plaster to a cut. First aid is usually performed by the layman, with many of us trained in providing basic levels of first aid, and others willing to try and do thus from acquired information. Mental health first aid is an extension of the idea of first aid to cover mental health.



Fig.6.2.1: First aid Pyramid

There are many situations which may require first aid, and many countries have legislation, regulation, or guidance which specifies a minimum level of first aid provision in certain circumstances. This can embrace specific coaching or equipment to be obtainable within the work area (such as an Automated External Defibrillator), the availability of specialist first aid cover at public gatherings, or necessary first aid coaching among learning institutes. First aid, however, doesn't essentially need any specific equipment or previous information, and may involve improvisation with materials offered at the time, usually by undisciplined persons.

Vital Signs	Good	Poor
Heart Rate	60-100 beats per minute	Less than 60 or greater than 100 beats per minute
Respirations	14-16 breaths per minute	Less than 14 breaths per minute
Skin	Warm, pink and dry	Cool, pale and moist
Consciousness	Alert and orientated	Drowsy or unconscious

Fig.6.2.2: Vital Signs

Awareness	Assessment	Action	Aftercare
<ul style="list-style-type: none"> <li>Observe</li> <li>Stop to Help</li> </ul>	<ul style="list-style-type: none"> <li>Assess what is required to be done</li> <li>Ask yourself, 'Can I do it?'</li> </ul>	<ul style="list-style-type: none"> <li>Do what you can</li> <li>Call for expert medical help</li> <li>Take care of your and the bystander's safety</li> </ul>	<ul style="list-style-type: none"> <li>Once you have assisted the victim, stay with him/her till expert care arrives</li> </ul>

Fig.6.2.3: Four A's of First Aid

While delivering First Aid always remember:

- Prevent deterioration.
- Act swiftly, deliberately and confidently.
- Golden Hour – First 60 minutes following an accident .
- Platinum Period – First 15 minutes following an accident.
- Prevent shock and choking.
- Stop bleeding.
- Loosen victim's clothes.
- Regulate respiratory system.
- Avoid crowding/over-crowding.
- Arrange to take victim to safe place/hospital.
- Attend to emergencies first with ease and without fear.
- Do not overdo. Remember that the person giving first aid is not a doctor.

Injury	Symptom	Do's	Don'ts
Fracture	<ul style="list-style-type: none"> <li>Pain</li> <li>Swelling</li> <li>Visible bone</li> </ul>	<ul style="list-style-type: none"> <li>Immobilise the affected part</li> <li>Stabilise the affected part</li> <li>Use a cloth as a sling</li> <li>Use board as a sling</li> <li>Carefully Transfer the victim on a stretcher</li> </ul>	<ul style="list-style-type: none"> <li>Do not move the affected part</li> <li>Do not wash or probe the injured area</li> </ul>
Burns (see Degrees of Burn table)	<ul style="list-style-type: none"> <li>Redness of skin</li> <li>Blistered skin</li> <li>Injury marks</li> <li>Headache/seizures</li> </ul>	<ul style="list-style-type: none"> <li>In case of electrical burn, cut-off the power supply</li> <li>In case of fire, put out fire with blanket/coat</li> <li>Use water to douse the flames</li> <li>Remove any jewellery from the affected area</li> <li>Wash the burn with water</li> </ul>	<ul style="list-style-type: none"> <li>Do not pull off any clothing stuck to the burnt skin</li> <li>Do not place ice on the burn</li> <li>Do not use cotton to cover the burn</li> </ul>

Bleeding	<ul style="list-style-type: none"> <li>• Bruises</li> <li>• Visible blood loss from body</li> <li>• Coughing blood</li> <li>• W o u n d / I n j u r y marks</li> <li>• Unconsciousness due to blood loss</li> <li>• Dizziness</li> <li>• Pale skin</li> </ul>	<ul style="list-style-type: none"> <li>• Check victim’s breathing</li> <li>• Elevate the wound above heart level</li> <li>• Apply direct pressure to the wound with a clean cloth or hands</li> <li>• Remove any visible objects from the wounds</li> <li>• Apply bandage once the bleeding stops</li> </ul>	<ul style="list-style-type: none"> <li>• Do not clean the wound from out to in direction</li> <li>• Do not apply too much pressure (not more than 15 mins)</li> <li>• Do not give water to the victim</li> </ul>
Heat Stroke/Sun Stoke	<ul style="list-style-type: none"> <li>• High body temperature</li> <li>• Headache</li> <li>• Hot and dry skin</li> <li>• Nausea/Vomiting</li> <li>• Unconsciousness</li> </ul>	<ul style="list-style-type: none"> <li>• Move the victim to a cool, shady place</li> <li>• Wet the victim’s skin with a sponge</li> <li>• If possible apply ice packs to victim’s neck, back and armpits</li> <li>• Remove any jewellery from the affected area</li> <li>• Wash the burn with water</li> </ul>	<ul style="list-style-type: none"> <li>• Do not let people crowd around the victim</li> <li>• Do not give any hot drinks to the victim</li> </ul>
Unconsciousness	<ul style="list-style-type: none"> <li>• No movement of limbs</li> <li>• No verbal response or gestures</li> <li>• Pale skin</li> </ul>	<ul style="list-style-type: none"> <li>• Loosen clothing around neck, waist and chest</li> <li>• Check for breathing</li> <li>• Place the victim’s legs above the level of heart</li> <li>• If victim is not breathing, perform CPR</li> </ul>	<ul style="list-style-type: none"> <li>• Do not throw water or slap the victim</li> <li>• Do not force feed anything</li> <li>• Do not raise the head high as it may block the airway</li> </ul>

Fig.6.2.4: First Aid for different types of injuries

1st Degree Burn	2nd Degree Burn	3rd Degree Burn	4th Degree Burn
Will recover itself in a few days. <b>Action Required:</b> Place under running water.	Serious but recovers in a few weeks. <b>Action Required:</b> Place clean wet cloth over the burnt area.	Very Serious and will require skin grafting. <b>Action Required:</b> Place a clean dry cloth over the burnt area.	Extremely Serious and requires many years with repeated plastic surgery and skin grafting, is life threatening. <b>Action Required:</b> Leave open and prevent infection.

Fig.6.2.5: Degree of Burns

## 6.2.2 CPR (Cardiopulmonary Resuscitation)

Cardiopulmonary resuscitation circulates blood that contains oxygen to the very important organs of a patient in cardiac arrest once the heart and respiration have stopped. It includes chest compressions and ventilations also the use of an automatic external defibrillator.

**Compressions:** One part of CPR is chest compressions. To make sure optimal patient outcomes, high quality CPR should be performed. You'll guarantee high-quality CPR by providing high-quality chest compressions, ensuring that the:

- Patient is on a firm, flat surface to allow for adequate compression. In an exceedingly non-healthcare setting you might find it on the ground, whereas in an exceedingly healthcare setting you may find it on a stretcher or bed.
- The chest is exposed to make sure correct hand placement and also the ability to envision chest recoil.
- Hands are properly positioned with the heel of 1 hand within the center of the chest on the lower 1/2 sternum with the opposite hand on top. Most rescuers realize that interlacing their fingers makes it easier to supply compressions while keeping the fingers off the chest.
- Arms are as straight as attainable, with the shoulders directly over the hands to build up effective compressions. Lockup elbows can help maintain straight arms.
- Compressions are given at the proper rate of a minimum of a hundred per minute to a most of one hundred twenty per minute, and at the correct depth of a minimum of two inches for an adult to promote adequate circulation.
- The chest should be allowed to completely recoil between every compression to allow blood to flow back to the heart following the compression.
- For adult co-workers, CPR consists of thirty chest compressions followed by two ventilations.

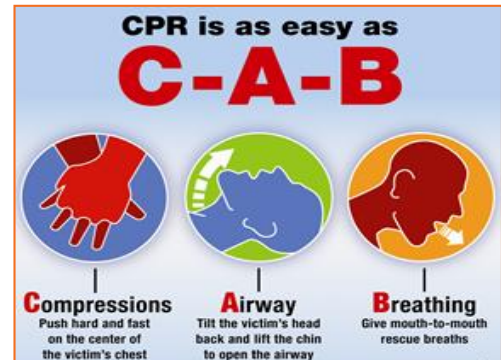

Fig.6.2.6: CAB

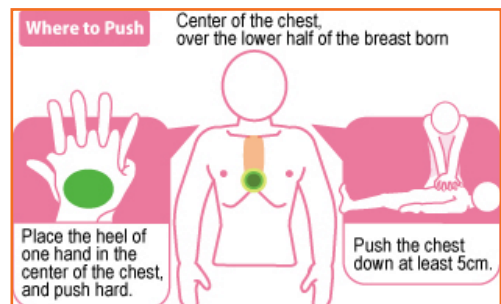

Fig.6.2.7: Compressions

## 6.2.3 Performing CPR for an Adult

- **Step 1:** Check the scene for immediate danger.
- **Step 2:** Assess the victim's consciousness.
- **Step 3:** Do not check for a pulse.
- **Step 4:** Check for breathing.
- **Step 5:** Place the victim on his or her back.
- **Step 6:** Place the heel of 1 hand on the victim's breastbone.
- **Step 7:** Place your second hand on top of the first hand.
- **Step 8:** Position your body directly over your hands.
- **Step 9:** Perform thirty chest compressions.
- **Step 10:** Minimize pauses in chest compression.
- **Step 11:** Make sure the airway is open.
- **Step 12:** Give 2 rescue breaths (optional).
- **Step 13:** Repeat the cycle of thirty chest compressions.



## UNIT: 6.3: Sensitivity towards People with disability and Gender Equality

### Unit Objectives

At the end of this unit, participants will be able to:

1. Elaborate the details about PWD Sensitization.
2. Explain gender sensitization and equality.

### 6.3.1 What is sensitization?

The process of becoming highly sensitive to specific events or situations (especially emotional events or situations) Sensitization doesn't always mean feeling the same pain the other person is feeling. It means knowing that the pain exists and there is a different way of living. Despite how the person lives, he or she has a right to exist in a society. It's an attitudinal change and very much required in current time.

#### Sensitivity to People with Disability

According to the Oxford Dictionary, a disability could be described as an impairment which can be Intellectual, limitations, cognitive, improvement, sensory, exercise or the mixture of all these. Incapacity impacts a person's activities and may happen at birth. Sometimes, it could happen in adulthood. In the medical model, individuals with certain physical, intellectual, psychological and mental impairments are taken as disabled. According to this, the disability lies in the individual as it is equated with restrictions of activity with the burden of adjusting with environment through cures, treatment and rehabilitation.

People with disabilities are subject to multiple deprivations with limited access to basic services, including education, employment, rehabilitation facilities etc. To work towards an inclusive, barrier free society by raising awareness and policy actions, there is a need to have comprehensive reliable statistics on people with disability and their socio-economic conditions

The Constitution of India ensures equality, freedom, justice and dignity of all individuals including persons with disabilities and mandates an inclusive society for all.

The Persons with Disabilities (Equal Opportunities, Protection of Rights and Full Participation Act, 1995) came into force on February 7, 1996. This was an important landmark and was a significant step in the direction of ensuring equal opportunities for persons with disabilities and their full participation in the nation building. The Act provides for both preventive and promotional aspects of rehabilitation like education, employment and vocational training, job reservation, research and manpower development, creation of barrier-free environment, rehabilitation of person with disability, unemployment allowance for the disabled, special insurance scheme for the disabled employees and establishment of homes for persons with severe disability etc.

In order to give focused attention to Policy issues and meaningful thrust to the activities aimed at welfare and empowerment of the Persons with Disabilities, a separate Department of Empowerment of Persons with Disabilities (Divyangjan) (DEPwD) under Ministry of Social Justice & Empowerment was set up in May 2012.

Empowerment of persons with disabilities is an inter-disciplinary process, covering various aspects namely, prevention, early detection, intervention, education, health, vocational training, rehabilitation and social integration.

The disability community is very diverse. Some individuals with a disability may be employed, while others may rely on public benefits as their main sources of income. Some of the public benefits they receive might have limitations. Income, resource and savings limits often prevent individuals from enhancing their financial wellbeing and self-sufficiency as they concentrate efforts on retaining their benefits

Rather than charities, disabled people need sensitivity of the society and initiatives to make their life easy.. New and existing programs are available to help people with disabilities develop skills in financial management and self-sufficiency. Government keeps trying to support in every possible manner so that they can earn their livelihood.

We learn so many virtues from disabled people like patience, courage, positive thinking etc .Hence; this gives us all the more reasons to have a developmental approach towards them. With so many technological breakthroughs happening all over the world, the Governments have spent in Research and development and innovations which would make the life of disabled people happier and easier.

For example, the invention of artificial limbs caused a revolution. They are available to the most disabled people and they can reap benefits from them.

Also, educating them and giving them jobs based upon their physical condition will make them feel a “sense of achievement” and increase their happiness quotient.

Also, disabled people should be trained by specialists in their fields so that they can try and overcome their shortcomings to the maximum extent possible and lead a life which is satisfactory and happy.

### 6.3.1.1 Myths and Stereotypes

We are all individuals with commonalities and differences and that is true for persons with disabilities as well. As an instructor, it is important to remember to not show pity or put an individual up on a pedestal – everyone should be treated as equals regardless of one’s abilities. When working with people with disabilities, it is important to avoid stereotypes. To debunk common stereotypes and myths, below are some key items to note about persons with disabilities:

- Persons with disabilities are all ages, come from diverse cultures and financial backgrounds.
- People with disabilities work.
- People with disabilities have families.
- Not all persons with disabilities are on or receive benefits such as ESI, Medicaid, etc.
- People with disabilities have goals and dreams.
- All people with disabilities do not necessarily want or need assistance.
- People who are blind or have low vision may wear glasses.
- People who are deaf may use their voice and may be able to read lips, but not all.
- Not all people who use wheelchairs are completely paralyzed – some may be able to walk short distances.
- Delayed or slow speech is not necessarily a sign of a slowed mental process.
- Persons with learning disabilities can be highly intelligent individuals; they simply have a different way of learning.

### 6.3.1.2 People's First Language

Positive language empowers people and helps them feel respected and important. When writing or speaking about people who have a disability, it is important to put the person first, usually addressing them by name or including them as a member of a group, such as a student or co-worker. Group designations such as “the blind,” “the retarded” or “the disabled” are inappropriate because they do not reflect the individuality, equality or dignity of people with disabilities.

Here are some general tips to keep in mind:

- **Offer to shake hands when introduced.** People with limited hand use or an artificial limb can usually shake hands and offering the left hand is an acceptable greeting.
- **Treat adults as adults!** Address people with disabilities by their first names only when extending that same familiarity to all others.
- **Ask First.** If you offer assistance (always ask before assisting someone), then wait until the offer is accepted. Then ask the individual with a disability for instructions on how you may assist them.
- **Relax.** Don't be embarrassed if you happen to use common expressions such as, “See you later” or “Did you hear about this?”, that seem to relate to a person's disability
- **Give them respect** as any other individual.

### 6.3.2 Gender Sensitization

#### What is Gender?

The socially constructed and culturally defined roles, responsibilities, attributes, and entitlements assigned to people based on their sex assigned at birth in a given setting, along with the power relations between and among the assigned groups.

Gender equality is the concept that all human beings, irrespective of their sex or gender identity, are free to develop their personal abilities and make choices without the limitations set by stereotypes, rigid gender roles, or discrimination.

#### What is Gender Bias?

- Gender bias is the tendency to make decisions or take actions based on preconceived notions of capability according to gender. People with disabilities have families.
- Not all persons with disabilities are on or receive benefits such as ESI, Medicaid, etc

It is the process of raising awareness and inculcating empathy about one's own and the other gender. Since one of the most common area of discrimination is based on gender, there is a great need to sensitize the youth on gender related issues. This would strongly contribute in ensuring that equal roles, responsibilities, opportunities, and expectations are assigned to both men and women. Training on gender sensitization will help break the stereotypes around job roles, women's participation in particular trades, and would support in equal participation of men and women in the decision-making process.

#### 6.3.2.1 Why is the Need for Gender Sensitivity

##### 1. Couple communication and decision-making

The role of men and women in household decisions about finances, food consumption, childcare, healthcare or travel often reflect power relations in the home. When power relations are unequal, it results in not only

one sided biased decision but also can increase risky sexual behavior and intimate partner violence. While it is important for women to play a larger role in important household decisions, such as financing, men should also become more involved in healthcare and household decisions around health.

Couple communication and joint decision-making have a positive impact on health outcomes.

## 2. Access to opportunities and resources

Gender-related factors also affect health outcomes through differential access to opportunities and resources like education, employment and healthcare.

- » **Education:** Gender roles often restrict both boys' and girls' access to education which can have long-term effects on health outcomes. For example, more educated women and formally employed women are more likely to use family planning, which reduces the risk of unwanted pregnancy and potentially, the need for abortion
- » **Employment:** In many contexts, women's traditional responsibilities are primarily domestic and they do not work outside the home. When they do, they are often part of the informal economy, in lower-paid and less-skilled jobs without opportunities to join unions or trade organizations that advocate for better pay or rights
- » **Healthcare:** Women's mobility may limit their access to health services and existing programs intended to increase knowledge of family planning or other health information. Men often do not go to health clinics for their own care or with their partner because pregnancy and child health are seen as a "woman's domain."

## 3. Social, cultural and gender norms

Norms related to gender, such as gender preference, masculinity and fertility, also influence health outcomes.

- » **Gender Preference:** In India, China, and to a certain extent in some African countries, there is a gender bias in child healthcare. Preference for boys can lead to financial resources for education and other services, like healthcare, being differentially allocated within households. Reasons for this preference vary, and include the perception that boys will financially support their parents when they are older, and that families are obliged to pay dowries when their daughters marry.
- » **Fertility:** In many areas, a woman's value is often measured by her ability to have children. This can lead women to put their own health or the health of their family at risk by starting pregnancy too early, when not yet physically matured, and giving birth without proper spacing or having more children than the household can support. For couples facing fertility issues, women often bear the brunt of household and community-level stigma and abuse for failing to conceive.
- » **Masculinity:** Masculine ideas associating men with strength, virility, dominance and power may increase the number of sexual partners and inhibit the use of condoms, thereby increasing the risk for unwanted pregnancy or the transmission of STIs or HIV through unprotected sex or sexual violence. These masculine norms also may promote or normalize violence against women

### Summary of Need for Gender Sensitization

- To provide balance to the society
- To provide equal opportunities to women and men
- To gauge views of all sections of society
- To distribute resources evenly
- To allow same personal freedom for men and women
- To even out the gender bias present in the society

**How to stop gender bias**

- Education that helps create attitudinal shifts towards gender bias and activities to spread awareness.
- Continuous efforts towards breaking myths and stereotypes around gender.
- Ensuring State accountability to implement various schemes, policies, laws, constitutional guarantees and international commitments.
- Institutionalizing gender sensitive processes within various systems such as law and programmes.
- Encouraging community ownership in preventing violations based on gender discrimination.

Sexual harassment at workplace is an extension of violence in everyday life and severely affects. Women's right to work in a safe and secure environment. While it is the responsibility of every employer to ensure safety of women at the workplace, it is also important for the trainees, both men and women, to be aware of all aspects of sexual harassment at the workplace. Skill training for both male and female trainees and professionals in the skilling ecosystem is centered around the following issues:

- What constitutes workplace sexual harassment?
- Where can the aggrieved complain about the same?
- What are the rights of the aggrieved?
- What is the redressal mechanism?
- Which are the bodies involved in addressing these complaints?
- What are the possible actions that can be taken against the accused?

**Resources**

Scan the QR code or click the link to access the videos or e-book.

Description	QR Code
Health related threats in apparel industry and control on them	 <a href="https://youtu.be/POIQ27GQZp0">https://youtu.be/POIQ27GQZp0</a>
First aid	 <a href="https://youtu.be/DQ7JPNgU8Wg">https://youtu.be/DQ7JPNgU8Wg</a>

Gender sensitization



<https://youtu.be/Wi1exdO1lig>

## Industry Visit

The purpose of visiting an apparel manufacturing unit is to get hands on knowledge about various processes involved in the work of an Store Keeper. During the visit you have to interact with self employed tailor and supervisors to understand how work is done in industry. Make sure that you keep a notebook handy and note down any important points that come up during your interaction at the apparel manufacturing unit. When you go to an apparel manufacturing unit, you should:

- Know about the production system.
- Understand the machine safety and maintenance rules of industry.
- Analyze how a tailor:
  - » Use and maintain personal protective equipment as per protocol.
  - » Maintain a healthy lifestyle and guard against dependency on intoxicants.
  - » Follow environment management system related procedures.
  - » Identify and correct (if possible) malfunctions in machinery and equipment.
  - » Store materials and equipment in line with manufacturer's and organizational requirements.
  - » Minimize health and safety risks to self and others due to own actions.
  - » Monitor the workplace and work processes for potential risks and threats.
  - » Carryout periodic walk-through to keep work area free from hazards and obstructions, if assigned.
  - » Report hazards and potential risks/threats to supervisors or other authorized personnel.
  - » Participate in mock drills/ evacuation procedures organized at the workplace.
  - » Take action based on instructions in the event of fire.
- Ask questions to tailors/supervisors if you have any query.



## Exercise

1. Heart rate of a healthy person should be:
  - a) 40-60 beats per minute
  - b) 70-110 beats per minute
  - c) 80-100 beats per minute
  - d) 60-100 beats per minute
1. What is not in Four A's of First Aid:
  - a) Awareness
  - b) Assessment
  - c) Action
  - d) Attitude
2. The symptoms of fracture:
  - a) Pain
  - b) Swelling
  - c) Visible bone
  - d) All of the above
3. Which degree of burn is explained as; Extremely Serious and requires many years with repeated plastic surgery and skin grafting to heal?
  - a) 1st Degree Burn
  - b) 2st Degree Burn
  - c) 3st Degree Burn
  - d) 4st Degree Burn
4. is a level of medical care which is used for victims of life-threatening illnesses or injuries until they can be given full medical care at a hospital.
  - a) Basic life support (BLS)
  - b) CPR
  - c) ABC
  - d) All of the above



# 7. Comply with Industry, Regulatory and Organizational Requirements and Greening of Job Roles



Unit 7.1 - Comply with Industry, Regulatory and Organizational Requirements and Greening of Job Roles

Unit 7.2 - Entrepreneurship

Unit 7.3 - Documentation



## Key Learning Outcomes

**At the end of this module, participants will be able to:**

1. Carryout work functions in accordance with legislation and regulations, organizational guidelines and procedures.
2. Seek and obtain clarifications on policies and procedures, from your supervisor or other authorized personnel.
3. Apply and follow these policies and procedures within your work practices.
4. Provide support to your supervisor and team members in enforcing these considerations.
5. Identify and report any possible deviation to these requirements.
6. Know the effect and importance of Greening of Job roles.

## UNIT 7.1: Comply with Industry, Regulatory and Organizational Requirements and Greening of Job Roles

### Unit Objectives

**At the end of this unit, participants will be able to:**

1. Carryout work functions in accordance with legislation and regulations, organizational guidelines and procedures.
2. Seek and obtain clarifications on policies and procedures, from your supervisor or other authorized personnel.
3. Apply and follow these policies and procedures within your work practices.
4. Provide support to your supervisor and team members in enforcing these considerations.
5. Identify and report any possible deviation to these requirements.
6. Know the effect and importance of Greening of Job roles.

### 7.1.1 Defining Compliance for Your Organization

According to Merriam Webster the dictionary definition of compliance is as follows:

1. The act or process of complying to a desire, demand, proposal, or regimen, or to coercion.
2. Conformity in fulfilling official requirements.
3. A disposition to yield to others.
4. The ability of an object to yield elastically when a force is applied.



Fig. 7.1.1: Regulatory Compliance

Supervisory compliance for industries, world- wide falls under the second definition. There are many managers, general councils, and policy officers that would consent in agreement at any of the other definitions as well. Let's discuss, what is compliance? Whether an organization is confronting an external regulatory compliance from a government agency, or seeks to comply with its own organizational mandates, policies or procedures, compliance in actuality means conforming to requirements and a proof that your organization has done so. This is usually attained by the scheming and development of managerial policies that will map out the projected code of conduct.

From a policy's point of view, there are many aspects that impact an organization's policies, including legislative and regulatory requirements, organizational best practices, and the market demands. If we look at government/ public sector agencies, financial service businesses, and healthcare providers - we find that they are controlled and must develop internal policies in order to ensure compliance. The actual trial comes from the juncture of practice with the laid policy.

After that, they must adopt ways to enforce those policies and measure their effectiveness. Initially this may seem to be an easy and convenient task. But the dilemma is creating a policy – without any mechanism, may it be manual, automated, or third-part, to measure and monitor compliance of the policies is very difficult. In order

to build effective policies, we must not only have an understanding of the statutory requirements that will shape the policy within our organizations, but how these policies relate to the business practices, the workforce, the methodologies of operations and the technologies within the corporation.

Irrespective of the requirements to which an organization must obey, a well-planned model is essential which will be one that assimilates strategies with their people, processes, and technology. This includes education, monitoring, and enforcement. Organizations should look to use machineries and to develop procedures that make it easier to do the right thing or to simply disregard the policy all together. In conducting performance audits, an assessment should be made of compliance with applicable laws and regulations when necessary to satisfy the audit objectives. The auditor should design the audit to provide reasonable assurance of detecting illegal acts that could significantly affect audit objectives. The auditor also should be alert to situations or transactions that could be indicative of illegal acts that may have an indirect effect on the audit results.

### 7.1.2 Significance of Compliance in Indian Garment Industry

Compliance is the standard for the product which ensures that it is aligned to its industry's qualitative demands. This also includes audits and inspections which are crucial to a proper and formal work environment. Compliance and its demand is rapidly growing in today's industrial scene since globalization of manufacturing standards has also created a demand for ethically created products. This standard of compliance is crucial because of the increase in export of garments from India.

#### Social Compliance

The treatment of the employees by its business constitutes social compliance. This also includes their environment and their personal perspective on social responsibility as an employee. The treatment of employees regarding wages, work conditions and working hours. A compliance audit is necessary in order to determine if the company meets standard environmental laws.

#### Compliance Audit

Process Safety Management, Risk Management Programs, and Process Security Management are all organised and provided by audits and assessments. Compliance and its verification is carried out with audits that focus particularly on these policies and procedures. The design and implementation of these audits ensures this compliance. Additionally, all sorts of deficiencies can be addressed and solved through corrective action.

In India, compliance audit consists of a thorough examination of orders, regulations, rules and directions for dealing with prudence, legality, transparency and adequacy. It is the job of auditors to collect information by reviewing documents, visually observing the site and staff interviews. This data is cross checked with applicable regulations and permits to ensure how well the operation is when sieved through applicable and required legalities.

There are three main phases of compliance audit in India:

1. **Pre-audit:** It includes planning and organising the audit; establishing the audit objectives, scope and etiquette; and reviewing the design of the program by inspecting documentation
2. **On-site audit:** It includes conducting personnel interviews, reviewing records, and making observations to assess program implementation
3. **Post-audit:** It includes briefing the management on audit findings, and preparing a final report

Therefore, Indian apparel manufacturers need to follow Government guidelines, and social compliance standards not only within their sphere of operations, but also insist their vendors, distributors, and other collaborators involved in the supply chain to do the same.

### 7.1.2.1 Core Labour Standards

International labour standards have grown into a wide-ranging system of gadgets on work and social policy, backed by a administrative system intended to address all sorts of complications in their submission at the national level

- Removal of Discernment in Employment and Occupation
- Freedom of Association
- Right to Collective Bargaining
- Elimination of all Forms of Forced or Compulsory Labour
- Effective Abolition of Child Labour

Apparel industry players would ensure that labour contractors don't involve forced labour or child labour and get the supply chain of the suppliers audited. Apparel Export Promotion Council (AEPC), a top organization of Indian apparel exporters, has envisioned a garment factory compliance program 'Disha' -Driving Industry towards Sustainable Human Capital Advancement. The prime objective of this body is to make India a global benchmark for social compliance in apparel Industrial. This Common Compliance Code design will prepare the Indian apparel industry on a mutual platform towards a more social and ecologically compliant industrial atmosphere.

### 7.1.3 India Adopting Universal Standards on Child Labour

The compliance level of garment factory is very high for Indian exporters. To ensure that all standards are being complied with, the big international companies, mindful of their branding, often generate and follow their own compliance standards. Numerous U.S. companies have incorporated "child labour" in their code of conduct, due to tenacious signal of child exploitation in the industry.

#### 7.1.3.1 Common Compliance Code

There is a compliance exhaustion in the Apparel Industry,. Although they are trading with the global brands, the apparel sellers still don't consent that compliance is an integral management practice. The Indian apparel export industry has been indisputable to implement zero tolerance on child labour and cleanse the supply chain.

"This common compliance code will not only give the opportunity for the industry to negate international claims against child labour promotion in the garment industry, but will also help to improve the image of the industry and win more international businesses," as per PremalUdani, Chairman, Apparel Export Promotion Council (AEPC).

### 7.1.4 Indian Garment Industry and Social Responsibility

The apparel industry of India, is one of the biggest segments among the various industries existing. It is also one of the oldest and an eminent industry in terms of output, investment and employment. A sector which has a global market share and has earned reputation for its permanence, worth and magnificence. The industry is growing at a fast pace with change in customer taste and inclinations. There are numerous factors impacting a change in customer preferences. Few of them are here:

- Rise in disposable incomes
- Government policy focused on fast-track growth



- Convenience of shopping at departmental stores and shopping malls
- Increasing demand for branded apparels and fashion accessories
- Boom in the retail industry

#### 7.1.4.1 International Labour Standards

The Indian apparel industry had established itself substantially not just in the domestic but global market too. The improved density from international apparel buyers to comply with labour principles and rights in Indian garment factories has resulted into a vast number of labels and code of conduct.

#### 7.1.4.2 Corporate Social Responsibility

Corporate social responsibility (CSR) fundamentally connotes that the establishment should work in a principled way. It should work in the best interest of the parties associated with it. The notion of social accountability and responsibilities in Indian apparel sector is fastening acceptance. Increasing number of companies are tiresome to work in a mode to defend the interests of the workforce, clients, contractors and the society.

#### 7.1.4.3 Social Responsibility in the Garment Industry

Garment firms have social responsibility associated with workforce and the surroundings. Social responsibility in the global clothing industry gives a deep examination of labour practices and values. But the ways by which the various organisations takes up to accomplish their social accountability may be different. A garment factory can fulfil its social responsibility in the following manner:

- By creating and providing a challenging environment to the workforce.
- Creation and provision of fair book of policies for any kind of employee dispute, if any.
- Affirm a safe and positive working environment for the employees.
- Prohibit child labour and abolish any kind of child abuse.
- Provision of equal opportunities to the employees to voice their feedback and have an effective policy for the solution of dispute.
- Ensure ethical recruitment, training, remuneration, appraisal and other policies.

#### 7.1.5 Indian Apparel Trade and Compliance Standards

The Indian garment industry is aiming to reach 7.5 billion by the end of 2012, a Fig that is practically double the size of the last profit intended by the Indian Chamber of Commerce (ICC).

With the increasing globalisation, a lot of prominence has been placed on global compliance standards in the garment industry. Factories involved in the international trade must keep a proper check of the garment factory compliance at regular interludes. Therefore, every apparel export business needs to have a proper understanding of compliance rules for foreign trade.

### 7.1.5.1 Why Code of Ethics is Required

The code of ethics is concerned with the quality of the products and services from the workstations along with the working environment that should meet the provisions of audits and assessments. If followed sincerely, these ethics will result into:

- Cumulative national afford ability in terms of social compliance.
- Growing competitiveness of small scale industrialists.
- Dropping burden on manufacturers.

Some of the compliance codes in Indian garment industry are listed below.

### 7.1.5.2 Working Hour & Wage Rate Compliance

- Garment workshops should ensure a confirmation that employees should get minimum wages as per the domestic law and according to their working hours spent by them in the industry.
- Employer should confirm an equal wages to both men and women employees who are performing the same work or work of a similar nature.
- Workforce employed for more than nine hours on any day or for more than 48 hours in any week, shall be qualified to wages at premium legal rates for such overtime work.
- Every employee must be entitled to one holiday in a week.
- Whenever a worker is required to work on a weekly holiday, he is to be allowed a compensatory holiday for each holiday so lost.

### 7.1.5.3 Tailoring Shop & Work Environment Compliance

- Businesses units should see that they are providing a proper clean, hygienic, well-ventilation, sufficient light and air to provide the workforce with standard work environment. A comfortable workstation with a clean and neat tailoring shop is a mandate.
- Indian garment industries should ensure that the workers are given a comfortable sitting chair with back support and proper leg space.

### 7.1.5.4 Non-discrimination Compliance

Under federal and state laws, it is in contradiction of the law for proprietors to differentiate staffs and job applicants and/or harassment to occur with their organizations. It is also against the law to treat people unethically or bother them because of the age, disability, homosexuality, marital or domestic status, race, sex or transgender status of any relative, friend or colleague of a job applicant or employee. Employers, managers and supervisors must treat all their job applicants and employees on the basis of their individual merit and not because of irrelevant personal characteristics. They must also do their best to make sure that their employees are not harassing any other job applicant or employee.

### 7.1.5.5 Social Compliance in India

Religion, community, culture or belief characteristics should never be the basis of distinction among employees by the organisation. All the terms and conditions of employment should be based on a person's ability to do the job. The mandate for social compliance is growing every day. One can accomplish a dynamic and vigorous compliance system only when the workforce is provided with an equal stand to voice their concern and have consultative instrument at the tailoring shop. The Apparel Export Promotion Council of India (AEPC), a summit framework of Indian apparel exporters, runs all social compliance services to meet international global standards. This council trains and monitors industrial unit to upgrade the factory conditions and labour values and standards.

### 7.1.6 Health and Safety Compliance in Indian Garment Industry

Apparel industry has won increased attention from consumers, social workers, welfare organisations and trademarked international buyers. Many global players are demanding that their "code of conduct" should be complied to, before entering into an agreement. Nowadays, continuous observance to quality standards and employee contentment have become significant bounds for gauging the company's performance.

Apart from the growing quality of outputs that meet transnationally recognised standards, it is essential for the suppliers to improve safety and health compliance code and provide proper working atmosphere in their work locations.

Numerous overseas countries have established various international compliance standards on safety and health compliance. Exporters should follow these codes to live on in the global market. One should not under-estimate the benefits drawn from regular drilling of compliance codes of conduct which can bring higher price of yields, less employee turnover rate, smooth trade relation as well as global image & status.

#### 7.1.6.1 Need for Compliance Codes

There is prominent impact of social compliance on company's economic outcomes. Companies should adopt compliance code to protect their goodwill and brand name in the market. The Indian apparel industry needs to be hard-hitting on compliance rather than opposing with other developing countries manufacturing low-cost garments.

#### 7.1.6.2 Role of Apparel Export Promotion Council in India

In India, the Apparel Export Promotion Council (AEPC) is committed to legal compliance and principled business Practices. It encourages members/exporters to comply with all applicable laws and regulations of the country to meet international compliance standards. Further, the council has designed a garment factory compliance program 'Disha' (Driving Industry towards Sustainable Human Capital Advancement) that aims to spread awareness regarding the importance of compliance among garment exporters.

### 7.1.6.3 Compliance Code Guidelines

Apparel factories ought to contemplate the below mentioned guidelines when complying with safety and health compliance code standards:

- Trades should comply with international standard code, such as ISO or importing countries standard code to become competitive in international markets.
- It is necessary for workers involved in loading and unloading operations.
- Young adults (between 15 to 18 years) are not allowed to work on any dangerous machine without sufficient training and supervision.
- Ear plugs or muffs should be given in places with excessive sound such as generator rooms and embroidery rooms.
- Factories should have effective fire extinguisher with proper usage instructions.
- Eye-wear and face shields should be a must, providing in areas with danger of flying objects, sparks, glare, hazardous liquids and excessive dust.

### 7.1.7 Compliance Code Guidelines for Indian Garment Industry

The Indian apparel industry supports considerably to India's export earnings. India has industrialised as a major following destination for various buyers. The USA and the EU endure to be the most domineering markets for Indian apparel industry, bookkeeping for about two-third of India's textiles exports. These countries have been demanding upon compliance to certain social, environmental and safety standards and norms by the manufacture units involved in export business. Corporate codes of conduct that discourses labour standards vary from corporation to corporation and location to location. Some of the common Indian Garment industry compliance code guidelines are:

- Exporters must not be intricate in unfair labour practices but limited to interferences in matters regarding freedom of association.
- Exporters shall recompense workforce for all hours operated. Workers on a piece rate payment scheme or any other incentive scheme should be paid according to that.
- Exporters shall not illogically restrain the liberty of movement of workers, including movement in canteen during breaks, using toilets, accessing water, or to access necessary medical attention, as a means to maintain work discipline.
- Exporters are about to offer workers with paid annual leaves as required under local laws, guidelines and processes. Exporters shall not impose any undue limitations on workers' use of annual leave or taking any type of sick or maternity leave.
- There shall be no alterations in workers remuneration for work of equal value on the basis of gender, race, religion, age, nationality, sexual orientation, social political opinion, disability or ethnic origin.
- Exporters shall not threaten female workers with firing or any other employment conclusion that adversely distresses their service status in order to avert them from getting married or becoming pregnant.
- Exporters shall confirm that proper ventilation systems are installed within their premises to prevent airborne exposures which may affect the health of workers.

- Members shall not custom any form of physical or mental, emotional violence, threats, harassment, or abuse against workers seeking to form organisations or participating in union activities, including strikes.
- Workers shall be permitted to at least 24 successive hours of rest in every seven-day period. If workers must work on a rest day, another successive 24 hours rest day must be provided.
- Exporters shall pay workers at least the legal minimum wage or the usual industry wage, the one that is Higher. This indeed is the most essential code of compliance for Indian Industry.
- Garment exporters must ensure that the minimum age requirement to unsafe employment shall not be less than 14 years. This is the most significant concern in the country. Each worker has the right to enter into and to terminate their employment freely. Indian apparel makers need to follow all the compliance rules to comply with global standards. Often companies adopt industry compliance codes to project a positive image and protect their goodwill in the market. The Indian garment industry needs to be strong on compliance instead of competing with other developing countries manufacturing inexpensive garments.

### 7.1.8 India Complying with International Standards on Child Labour

Child labour has been a grave crime in India. It still exists. Children are in poverty, ignorance, and corruption due to illiteracy. Child labour superfluties under many conditions such as discernment (based on gender, ethnic, or religious issues), inaccessibility of educational and other substitutes, weak enforcement of child labour laws, etc. Large global firms, conscious of their image, often set up their own compliance standards for the exporters to ensure that all standards are being complied with. Various companies of U.S originality have included child labour in their code of conduct, due to tenacious evidence of child exploitation in the industry. In worldwide market, the buyer's compulsory requirement is to have an audit. As India is a leading garment exporter, the level of garment factory compliance is very high for Indian exporters. The child labour issue is one of the very important aspect that the audit checks. Therefore, all the export units must be highly compliant on issues related to child labour.

#### 7.1.8.1 Code of Conduct for Garment Exporters

- Garment exporters must safeguard that the bottom limit of the age requirement to non-hazardous employment should not be less than 14 years. Moreover, all young workers (between 14 to 18 years) must be sheltered from doing any work that is likely to be dangerous or that may be injurious to their health and physical, mental, social, or moral development. Exporters must detect all legal necessities for work being performed by lawful young workers.
- Further, the trainees or occupational students shall not be under the legal age for employment (as provided under the applicable laws). They cannot be used on regular production lines as long as they are trainees and unless their pay and other benefits are at par with the regular workforce.
- A proper process is followed for checking the age of the workers. The minimum certification and credentials required to be maintained shall include- proof of age certificates by registered/ licensed dentists, birth certificate, school leaving certificate, national identity like passport, driving license, voter card etc. or any other document required under the applicable laws.

## 7.1.9 Green Jobs

*“Green jobs’ are defined as jobs that reduce the environmental impact of enterprises and economic sectors, ultimately to levels that are sustainable.”*

Green jobs can produce goods or provide services that reduce environmental impact, such as green buildings or clean technology adoption. An important section of green jobs lies in sustainable or clean manufacturing. India has already begun preparation towards a green transition by institutionalizing capacity buildings for green jobs through jobs, including legal regulations and skill mapping. The country is accelerating the expansion of green jobs in large industries like automotive, textile, brick manufacturing, power sector, and green buildings. It is gradually expanding its coverage to hard-to-abate sectors such as steel, thermal power plants, and manufacturing SMEs.

India will soon be the most populous country in the world – and home to one of the youngest populations. India is the world’s third-largest energy consuming country, with 80 per cent of demand met by coal, oil and solid biomass. Despite its efforts, India is predicted to be among the top three emitters by 2030. Millions of Indian households are set to buy new appliances, air conditioning units and vehicles.

Rapid growth is expected in building stock, other infrastructure, and construction materials. In recent years, India created a massive expansion in renewable energy. India’s efforts at promoting LED lighting are a huge success story. Over 367 million LED bulbs, 7.2 million LED tube lights and 2.3 million energy efficient fans have been distributed. This has brought big savings in power use, greenhouse gas emissions and household bills.

India has also taken steps to control plastic pollution, including bans on single-use plastic and strengthening extended producer responsibility. India has also committed to restoring 26 million hectares of degraded land by 2030. But India, like every nation, must do more. And doing more is in the best interests of the entire nation. A recent World Economic Forum estimate suggests that India’s decarbonization journey represents a USD 15 trillion economic opportunity by 2070. This journey could create as many as 50 million net new jobs.



Fig.7.1.3: Diversified green jobs

### About sustainability and sustainable workplace

Sustainability, greening the corporation, environment management are gradually becoming a part of the corporate vocabulary. The way the natural resources are extracted and consumed from earth, it is going to be very difficult to replenish them timely. It is often discussed in various forums that for generating the resources we spend in one year; earth takes around 1.5 years for the re-generation. Hence, it can be assumed that there will a requirement of the capacity of almost two Earths by 2030 to keep pace with the present natural resource consumption, and the requirement will be of three planets by 2050.

The current requirement is towards developing long-term, meaningful relationships, and self-discipline for attaining effective results. Thus, the design of the workplace is such that supports the basic and core idea in a more accommodating and comprehensive manner.

A Green workplace is an eco-friendly and focused organisation and leans towards the adoption of business practices that are justifiable in nature, energy efficient, and well suited to the complex as well as the ever changing world of business. It advocates the model based on 3Rs — reduce, reuse, recycle. It encompasses green competencies, green attitude, and green behaviour, which is combined synergistically to help the organisation become green or sustainable. Values are the essential characteristic that both employees and organisations uphold and operate at multiple levels (societal, organisational and personal), thus playing a fundamental role in shaping the organisation’s culture with regard to a shift towards greater sustainability.

The idea of introducing green initiatives into the workplace can feel a little daunting at first. And while it may feel overwhelming trying to figure out where to start, there are actually lots of ways we can be more green in the office without bringing the whole forest inside, without huge cost implications and with long-term benefits to the company, employee well-being and future spend. Implementing a few simple changes for a more sustainable, green workplace can be really effective in reducing your business’ impact on the environment.

Sustainability is now counted as one of the major pillars of apparel export business and a growth tool. Though its key areas involve saving of energy, water, more greenery in the factories, maximum use of natural resources, green factories, there are many other initiatives which are being taken by various companies as per their need, priorities, and with the changing sustainability landscape, bench marks and issues are also evolving. All these efforts are generating great results, bringing buyers closer to them and creating a sense of profitability and responsibility amongst the companies towards the people and the planet.

**A Few Green workplace initiatives**

1. Discourage food and water wastage
2. Switch off the lights or power when not in use
3. Switch off the sewing machine when not in use
4. Stop using Single use Plastic
5. Segregate waste as per waste management/disposal policy
6. Any sort of wastages like empty glasses/bottles/plastics/containers etc should be kept in a specific area to be recycled
7. Throw waste only in the allocated basket or trolley
8. Minimise use of paper
9. Use of LED lights
10. Installation of solar panels

Encourage similar practice at home also.



## UNIT 7.2: Entrepreneurship

### Unit Objectives

**At the end of this unit, participants will be able to:**

1. Describe the importance of being an entrepreneur.
2. Explain the concepts of tailor shop economics like book keeping, inventory management.

### 7.2.1 An Entrepreneur

An entrepreneur is a person who runs his/her own business. Entrepreneurs are the ones who explore opportunities, scan the environment, mobilize resources, and transform notions and ideas into practicable business proposition, providing new products and services to the society by bringing together and merging various factors of production. An entrepreneurial individual has a distinct concept, vision and a dream, which he/she is able to convert into products. Such individuals are driven by task, challenge and opportunity with very high achievement orientation.

### 7.2.2 Accounting

Book keeping is an activity that is unkempt by small scale entrepreneurs, even in literate populations. Maintaining separate accounts for the daily purchase and bill for tailoring services will be helpful in:

- Understanding how money is spent and income is earned.
- Finding ways of reducing expenses and increasing incomes i.e. increasing profits.
- Making decisions about purchase of inventory.
- To get a correct picture of the income, expenditure and profits (or losses), everything of value in the shop and all transactions involving payments and receipts of money must be recorded.

#### Single- entry book keeping

Single-entry book keeping is a simple method of accounting. A single book is maintained to enter all transactions, whether they are payments made out or income received by the shop owner or tailor. Some key points to remember while keeping a single-entry book are:

- Fill in the book every day or at least every week. Enter all transactions including payments and income
- Keep receipts, invoices, statements and other business documents together with a clip or in a file

For example, if someone (a buyer) gives you a bill or an invoice the following data should be recorded in the single-entry book:

- Amount of money received
- Quantity of material received
- Invoice numbers

An example of a single-entry book is shown below:

Item	Date	Description	Payment	Income
1	10-1-14	Threads (40 Pcs @ 3.00)	120.00	-
2	12-1-14	Fabric sales-received from ABC.	-	310.00
3	12-1-13	Payment to labourer	50.00	-
4	13-1-14	Other Expenses	60.00	-
5	14-1-14	Payment of loan	96.00	-

Fig.7.2.1: Single- entry book keeping

Some important aspects of financial management are given below:

#### Profit and Loss

Even though income and expenditure are recorded everyday in this manner as and when actual transactions take place, the profits (and losses) are usually calculated for longer periods e.g. for a year. For calculating profits (and losses), the items of expenditure and income during the period under consideration are summarised under three main sections:

- **Capital items:** Capital items are those having a longer life and a higher value e.g. land, buildings, equipment such as machines.
- **Recurrent items:** The recurrent (or consumption) items are those that get used up in the production process e.g. thread, needle fabric, disinfectants, medicines, soap, and various miscellaneous items.
- **Loans** (and payment of loan instalments including interest).

#### Cash flows

It is also imperative to know about the timing of receipts and expenditure of money. If money is not available from the enterprise to meet the expenditure at the correct time, e.g. arranging the raw material and manpower he may lose the business opportunity.

### 7.2.3 Client Management

For a tailor it is very important to manage relations with clients. By maintaining cordial relations with clients, the tailor can benefit financially as well as benefit from finding new linkages. There are generally two kinds of clients:

**Buyers/Customers:** These are the people who buy finished garments from you to sell them to others. In other words, they are not the direct users of the products. They might be wholesalers, who supply products to the retailers.

**Consumers:** These are the people who directly consume the products (for example a consumer who get a shirt made for himself)

One has to understand that there are a number of tailoring shops in the market and if good relations are not maintained with the clients, they can easily move on to some other tailors. A business remains in the market successfully only by sustaining good relations with each of the client. Clients can be satisfied with the goods and services provided by you :

- When they are happy with the features and quality of the product
- When the price of your product is reasonable (reasonable means within the budget)
- When one delivers on time and maintains agreed terms
- When extra efforts are put in to make them happy; like by working overnight to deliver on time

Another important benefit of managing good relations with the clients is that they can provide more detailed and accurate information on the market trends. E.g. a wholesale buyer can update with the expected change in demand of a new design of blouse or shirt or even tell you about the arrival of a new tailor. This information can help you to manage your production accordingly and also to decide prices in a better way.

It is also advisable to keep a detailed record of the different clients that are associated with you. The record may include:

- Client's name
- Contact number
- Quantity of goods sold (daily, weekly or monthly)
- Financial details (money received/money given)

Once you have good relations with the client, you can understand their needs and requirements in a better way and hence serve them well.

## UNIT 7.3: Documentation

### Unit Objectives

**At the end of this unit, participants will be able to:**

1. Define importance of being an entrepreneur.
2. Explain the concepts of tailor shop economics like book keeping, inventory management.

### 7.3.1 Introduction

Documentation is one the most crucial aspect of every job. By completing documents it is ensured that details of every transaction/event/incident are recorded and can be accessed when required.

Due to limitations of human memory, it is very difficult to remember each transaction and its details. In order to keep a record of all the transactions, routine or special, tailor maintains and updates different types of registers. The importance of this information varies with time and situation. Some information is casual and day to day observation, while others are unusual and spontaneous. Due to limitations of human memory, a tailor's recall capacity is limited. Important events/incidents can be recalled with accuracy if some writing exercise is carried out and notes are made.

### 7.3.2 Maintaining Registers

The need for maintaining registers is explained below:

- To keep a record of transactions carried out
- To maintain order and uniformity in recording details
- A register is a documentary proof of a transaction carried out
- Gives a consolidated summary of a particular kind of transaction in a given period
- Can be used as a legal document
- Details of a past event can be retrieved whenever required
- To provide statistics of daily/monthly movement of men/material
- To maintain proper records of an incident on a day for future reference

According to the requirement, the tailor can use some registers. Commonly used registers are:

- Handing/Taking over Register
- Visitor Register (In/Out Register)
- Measurement Register
- Material Register

While maintaining a register a tailor should always remember the following key aspects:

- Register is to be named and all the pages are to be numbered



MEASUREMENT CHART  
BODICE FRONT AND BACK

Measurement	Size 10		Personal
	Inches	Centimeters	
1. Full Front Length.....	18	45.7	17.5
2. Center Front Length.....	15 1/4	38.8	13
3. Front Shoulder Width - Total.....	14 3/4	37.5	18
Divided by 2.....	7 3/8	18.7	9
4. Front Shoulder Slope - Right.....	17 3/4	45.0	17
Front Shoulder Slope - Left.....	17 3/4	45.0	17
5. Shoulder Length.....	5 1/2	14.0	6
6. Body Width			
Depth of Body Width is Center Front Length (Number 2) divided by 3.....	5 1/12	12.9	(= 4 3/4)
Body Width - Total.....	36	91.4	4 3/4
Including 1 1/2" (3.8 cm) ease....	37 1/2	95.2	36
Half of Body Width - Total, including ease.....	18 3/4	47.6	32.5
Front Body Width = 20" + (0.75") One fourth of Body Width - Total, including ease, plus 1/2" (1.3 cm)	9 7/8	25.1	18.75
Back Body Width = 16" + (0.75") One fourth of Body Width - Total, including ease, minus 1/2" (1.3 cm)	8 7/8	22.5	10 1/4
7. Chest Width - Total.....			
Divided by 2.....			

Fig.7.3.3: Measurement Register

### 7.3.3 Cost Sheet

A statement which provides for the assembly of the detailed cost of a centre or a cost unit. It is also a periodical statement.

A cost sheet is prepared to know the outcome and breakup of costs for a particular accounting period. Columnar form is most popular. Although cost sheets are prepared as per the requirements of the management, the information to be incorporated in a cost sheet should comprise of cost per unit and the total cost for the current period along with the cost per unit and the total cost of preceding period. Data of financial statement is used for preparation of cost sheet. Therefore, reconciliation of cost sheet and financial statement should be done on a regular interval.

The expenditure which has been incurred upon product for a period is extracted from the financial books and the store records and set out in a memorandum statement. If this statement is confined to the disclosure of the costs of units produced dividing the period, it is termed as Cost- Sheet, but where the statement records both total cost, profit and sales, it is usually known as Statement of Cost or Production Account.

Cost Sheet				
<b>Date</b>	12-03-2016	<b>Description</b>	Kameez with waist band	
<b>Size</b>	M	<b>Colour</b>	Blue	
<b>Selling Price</b>	Rs 758			
<b>1. Material</b>	<b>Meters</b>	<b>Price</b>	<b>Amount</b>	
Cotton	4	Rs 65/meter	Rs 260	
Lining	-	-	-	
Total Material Cost (1)				Rs 260
<b>2. Trimmings and Accessories</b>	<b>Quantity</b>	<b>Price</b>	<b>Amount</b>	
Buttons	4	Rs 0.5/button	Rs 2	
Pads				
Zippers				
Waist Band	1	10	10	
Elastic				
Total Trimmings and Accessories Cost (2)				Rs 12
<b>3. Labour</b>				
Cutting			Rs 20	
Sewing			Rs 250	
Total Labour Cost (3)				Rs 270
Total Cost (1+2+3)				Rs 542
Markup (profit)	@40 %			Rs 758

Fig.7.3.4: A typical cost sheet







## 8. Soft Skills

- Unit 8.1 - Introduction to the Soft Skills
- Unit 8.2 - Effective Communication
- Unit 8.3 - Grooming and Hygiene
- Unit 8.4 - Development of Interpersonal Skill
- Unit 8.5 - Social Interaction
- Unit 8.6 - Group Interaction
- Unit 8.7 - Time Management
- Unit 8.8 - Resume Preparation
- Unit 8.9 - Interview Preparation



## Key Learning Outcomes

**At the end of this module, participants will be able to:**

1. Interpret the basic meaning of Soft Skills, their components and their benefits.
2. Interpret Work Readiness and its significance.
3. Explain communication process.
4. Explain about verbal and non- verbal communication.
5. Explain about the barriers in communication process.
6. Maintain cleanliness and hygiene.
7. Identify specific uniform guidelines
8. Maintain positive body language while speaking.
9. Interpret good eating habit and their impact on health.
10. Develop a positive attitude and behavior.
11. Explain team dynamics.
12. Explain how to manage relations.
13. Learn about Stress and anger management skills.
14. Learn to develop leadership qualities.
15. Explain about what is social interaction and what are social interaction behaviors.
16. Practice Self introduction in public.
17. Participate in group discussions in the class.
18. Identify the importance of team building and team work.
19. Explain about the time management.
20. Develop time management skills.
21. Learn about effective time planning.
22. Interpret the importance of resume.
23. Learn how to prepare a resume.
24. Explain the procedure of interview.
25. Practice mock interview.
26. Identify how to present themselves during an interview.

## UNIT 8.1: Introduction to the Soft Skills

### Unit Objectives

**At the end of this unit, participants will be able to:**

1. Interpret basic meaning of Soft Skills, their components and their benefits.
2. Explain the components and their benefits.

### 8.1.1 What is a Soft Skill?

Soft skills are personal attributes that describes an individual's ability to interact with others. Soft skills is a term often associated with a person's EQ, the cluster of personality traits, social graces, communication language, personal habits, friendliness and optimism that characterise relationship with other people. Soft Skills complement hard skills which are occupational requirements of a job and many other activities. They are related to feelings, emotions, insights and an inner knowing.

Soft skills have more to do with who we are than what we know. As such soft, skills encompasses, the character traits that decide how well one interact with others and are usually a definite part of one's personality.

According to a survey the long term success in job is 75 % due to soft skills and 25 % due to technical knowhow. Soft skills also determine how satisfied and happy one remains in professional and personal situations.



Fig.8.1.1: Soft skills

### 8.1.2 Components of Soft Skills

- Adaptability
- Emotional Strength
- Leadership Quality
- Team Playing Ability
- Decision Making
- Interpersonal Communication
- Negotiation Skills

### 8.1.3 Benefits of Soft Skills

Some of the benefits of Soft Skills are as:

- Increased credibility with customers.
- Increased customer satisfaction.
- More productive employees.
- Out service the competition.
- Recognition from the industry, employer and peers.
- New employment opportunities.
- Increased ability to perform on the job.

## UNIT 8.2: Effective Communication

### Unit Objectives

**At the end of this unit, participants will be able to:**

1. Explain the meaning of Communication and process of communication.
2. Elaborate about the types of communication.
3. Identify the barrier in effective communication.

### 8.2.1 Introduction

In the information age we have to send, receive and process huge number of messages everyday. But effective communication is more than just exchanging information, it also about understanding the emotion behind the information. Effective communication can improve relationship at home, work, and in social situations by deepening our connections to others and improving teamwork, decision making and problem solving.

*Effective communication skill is a learned skill, it is more effective when it's spontaneous than formula.*

### 8.2.2 The Communication Process

The process of conveying information through the exchange of thoughts, ideas, feelings, intentions, attitude by speech, gesture, writing etc. is known as communication. It is the meaningful exchange of information between two or more participants.

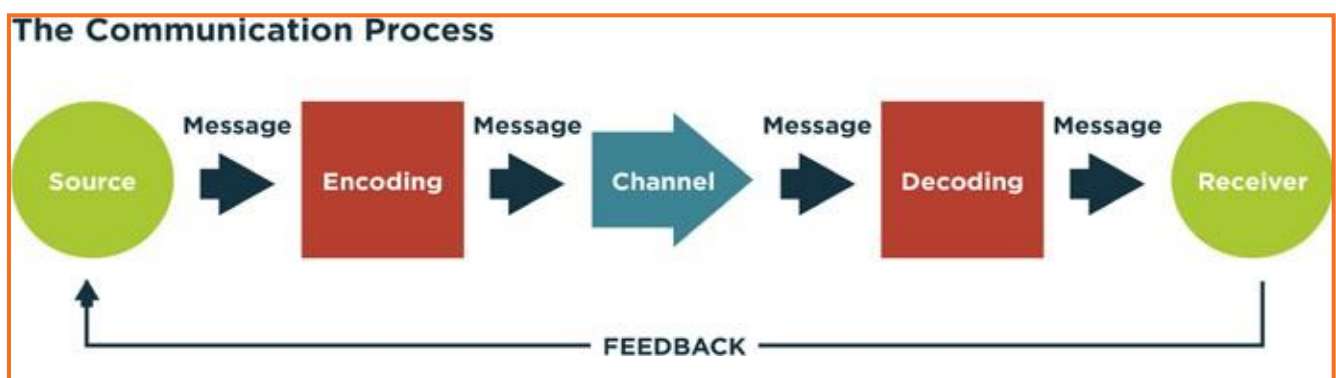

Fig.8.2.1: The Communication Process

Communication requires a sender, a message, a medium and a recipient. Communication process is complete only when a receiver understands the sender message.

Communication with other involves three steps:

1. **Message:** First information exists in the mind of the sender. It can be a concept, idea, formation and feeling.
2. **Encoding:** A message is sent to the receiver in words or other symbols.
3. **Decoding:** Lastly the receiver translates the words or symbols into a concept or information that a person can understand.

### 8.2.3 Verbal and Non-Verbal Communication

Communication can be categorized into three basic types. These include:

1. **Verbal Communication:** It means you listen to a person to understand their meaning. Verbal communications have the advantage of immediate feedback, are best for conveying emotions and can involve storytelling and crucial conversations.
2. **Written Communication:** letters, books, newspapers are printed messages in which you read their meaning. They are asynchronous, can reach many readers and are best for conveying information.
3. **Nonverbal Communication:** It means you observe a person and infer meaning. Both verbal and written communications convey nonverbal communication and are also supported by body language, eye contact, facial expression, posture, touch and space.

### 8.2.4 Communicating Effectively Identifying Barriers

There are many reasons why communications fail. These failures are the result of barriers in communication which may occur at any stage in the communication process. Barriers may lead to one's message becoming distorted and therefore risk wasting both time and money by causing confusion and misunderstanding. Effective communication involves overcoming these barriers and conveying a clear and concise message.



Fig.8.2.2: Barriers in Communication

A skilled communicator must be aware of these barriers and try to reduce their impact by continually checking understanding or by offering proper feedback.

#### Dealing with Barriers

- Use simple, easily understood word. Overcomplicating makes things confusing
- While speaking in other language always prepare beforehand
- Always give or take feedback to ensure the effectiveness of communication
- Be alert to cues
- Listen, listen, listen ...



### 8.2.5.1 Some Tips for Active Listening

- Concentrate what the person is talking about and not on noise or other external distractions.
- Understand his emotions and you get it all right. Is the speaker angry, happy or plainly inquisitive?
- When the speaker is saying or telling something, don't break the chain of his thoughts.
- Don't avoid completing sentences of the speaker. Let them speak and speak only after they finish.
- It's alright if you haven't understood at first chance. Request to repeat the information.
- Practice makes a man perfect. Listen intently, focus and ignore other noises. Listen more and talk when required.

It takes a lot of concentration and determination to be active listener. Old habits are hard to break and if you're listening habits are not good then you have to break those. Start listening deliberately and remind yourself frequently that your goal is to hear truly what the other person is saying.

## UNIT 8.3: Grooming and Hygiene

### Unit Objectives

**At the end of this unit, participants will be able to:**

1. Maintain cleanliness and hygiene.
2. Keep their dress clean and tidy.
3. Maintain positive body language while speaking.
4. Enable to perform more of the do's than the don'ts.
5. Avoiding bad things such as gutkha and alcohol.

### 8.3.1 Personal Grooming

Personal Grooming is the term for how people take care of their body appearance. Once you enter your store/ department you need to be dressed in full uniform as per company norms, and also properly groom yourself as per the service standards.

Personal grooming not only makes us presentable to other people but good personal hygiene is essential for good health. Habits that are considered personal grooming include, bathing, dressing, applying makeup, hair removal and taking care of one's teeth and skin.

### 8.3.2 Positive Body Posture and Language

- Clean hands at all times as they mostly will be handling merchandise and customers.
- Avoid biting nails on the floor.
- Manage body odour & bad breath to be under control as they are offensive to the customer.
- Maintain straight & upright posture on the shop floor.
- Slouching on the floor, hands in pockets, hands on the hips are not courteous to the customer.
- Keep your hands out of your pocket
- Don't Fidget. Fidgeting is a clear sign of nervousness
- Keep your eyes forward. This indicates that you are interested in communication with other.
- Stand up straight with your shoulders back. It communicates confidence.
- Don't cross your arms when meeting other persons.

### 8.3.3 Personal Hygiene

Personal Hygiene is the set of practices to follow to preserve one's health. Maintaining a high level of personal hygiene will help to increase self-esteem while minimizing the chances of developing infections. Poor personal hygiene can have significant implications on the success of job applications or chances of the promotion.

### 8.3.4 Physical Fitness

Apart from following these hygienic practices, one should also be physically fit. Physical fitness is an outcome of regular exercise. Exercise may be of many different forms. Jogging, morning-walk, weight-lifting, gym, swimming, cycling, yoga and many more.

#### **Things to be avoided**

There are certain habits that have severe ill-effects on one's health. Such habits should be avoided for a healthy life.

- Alcoholism
- Tobacco / Smoking
- Gutkha

## UNIT 8.4: Development of Interpersonal Skill

### Unit Objectives

**At the end of this unit, participants will be able to:**

1. Develop a positive attitude and behaviour.
2. Describe the goal setting.
3. Motivate for team participation at work.
4. Practice relations and stress management at work.
5. Develop leadership qualities.

### 8.4.1 Introduction

Interpersonal skill development is the blend of different traits of day to day life that play an important role in creating our impression in other's mind. It starts from inside. The role of interpersonal skill development is to help us understand how to make choices about our attitudes and actions.

**These include various traits like:**

- Positive Attitude
- Motivation
- Goal Setting
- Team Work
- Managing Relations
- Etiquette
- Stress and Anger Management
- Conflict Resolution

### 8.4.2 Goal Setting

Goal setting is a powerful process for thinking about your ideal future. The process of setting goals helps you to choose where you want to go in life.

Goal setting involves establishing specific, measurable, achievable, and realistic and time targeted goals. Goal setting helps people work towards their own objectives. Goals are a form of motivation that sets the standard for self-satisfaction with performance. Achieving the goal one has for oneself is a measure of success and being able to meet job challenges is a way one measures success in the workplace.

1. Financial
2. Education
3. Family
4. Health
5. Public Service

### 8.4.3 Team Dynamics

A team comprises a group of people associated for a common purpose. Teams are especially appropriate for conducting complex tasks. A team is a special instance of a group in which shared goal is the common thing. This creates a dynamic between team members and because they are dependent on each other for success. For example a sports team wins or loses as a whole.

#### Factors of Team Dynamics

- Tolerance and Cooperation
- Set aside feelings of caste, creed, profession
- Put up with each other
- Identify strengths of each
- Who can do what

### 8.4.4 Managing Relations

We all have different personalities, different wants and needs, and different ways of showing our emotions which affects people around us.

70% of the workplace learning is informal, when people talk to each other at work they actually are learning to do their job better. Friendlier workers are effective communicators, more productive and trusted more by employers and co-workers.

#### Stress and Anger Management

Anger is a normal and a healthy emotion. Managing anger can be a problem for some people who find it difficult to keep their anger under control. There are many health issues related to a unresolved anger such as high blood pressure, heart attack, depression, anxiety, colds and flu and problems related with digestion.

#### Always remember:

- Avoid unnecessary stress, learn to say no and take control of your environment.
- Express your feelings instead of boiling them up.
- Accept the things you can't change.
- Learn to forgive.
- Don't react immediately.
- Post pone for a few seconds whatever you wish to say or do.
- Take a deep breath.
- Speak when you have calmed down.

### 8.4.5 Etiquette

Etiquette are the customs or rules governing behaviour regarded as correct or acceptable in social and official life. It includes:

- Making Positive Impression
- How you treat with people
- Communicating at Workspace
- Work Ethics
- Discipline
- Commitment to work:
- Punctuality
- Ownership and responsibility
- Striving to excel:

### 8.4.6 Conflict Resolution

#### What is a Conflict?

A problem or a situation that may be difficult to understand or to deal with.

#### Why do we need to resolve conflicts?

- If a problem is not solved or addressed at the right time it may blow out of proportion
- An unsolved problem can be like Cancer which spreads and translates itself into all other areas in life
- Unsolved problems may lead to increased levels of bitterness and frustration
- It may foster bad habits like back-biting, gossiping, etc.
- Persons involved in conflict may lose focus and target each other's character instead of the specific behavior to be modified.

#### How to work out Conflicts?

- **STOP** - before you lose control of your temper and make the conflict worse.
- **SAY** - what you feel is the problem. What is causing the disagreement? What do you want?
- **LISTEN** - to the other person's ideas and feelings.
- **THINK** - of solutions that will satisfy both of you.

If you still can't agree, ask someone else to help you work it out.

### 8.4.7 Leadership Skills

The ability to lead effectively is based on a number of key skills. These skills are highly sought after by employers as they involve dealing with a number of people in such a way as to motivate, enthuse and build respect. Some of the qualities that every good leader should possess are:

- Honesty

- Ability to delegate
- Ability to take initiative
- Good communications skills
- Confidence
- Commitment
- Positive Attitude
- Creativity
- Be decisive
- Focus on the big picture



## UNIT 8.5: Social Interaction

### Unit Objectives

**At the end of this unit, participants will be able to:**

1. Analyze the social interaction.
2. Define duties and responsibility.
3. Explain about the team work.

### 8.5.1 Social Interaction

Social interaction is the process by which we act and react to those around us. It includes those acts people perform toward each other and responses they give in return. Social interaction includes a large number of behaviours. They are:

- Exchange
- Competition
- Cooperation
- Conflict
- Coercin

### 8.5.2 Self- Introduction

Everyone in their lifetime, have to introduce themselves to the audience or a class. It is a speech which lies around 3 minutes to 5 minutes. It is very important that it gives the first impression to other about us. It has a great impact on your self-esteem and self-confidence. It's helpful in:

- Feeling better about yourself
- Boosting your confidence
- Building your self esteem
- Making friends
- Feeling in control

#### Points for Self Introduction

- |                 |                               |
|-----------------|-------------------------------|
| • Wishes        | • Location                    |
| • Purpose       | • Hobbies/Habits              |
| • Name          | • Life Aim                    |
| • Father's Name | • Achievements                |
| • Family        | • Favourite Person's or Ideal |
| • Profession    | • Your Strengths and Weakness |

### 8.5.3 Cooperation

Cooperation is the process of groups of organisms working or acting together for their mutual benefit. Cooperation among family members, friends and peers is very common and healthy. It is the backbone of any society.

Family cooperation provides an avenue for a family to come closer. It increases coping skills and decision making.

**Experiential Knowledge:** contributes to solving problems and improving quality of life.

- **Emotional support:** Esteem, attachment and reassurance
- **Instrumental Support:** Material goods and services.

#### How to be a cooperative person

For being a cooperative person following things needs to be done:

- Listen carefully to others and be sure you understand what they are saying.
- Share when you have something that others would like to have.
- Take Turns when there is something that nobody wants to do, or when more than one person wants to do the same thing.
- Compromise when you have a serious conflict.
- Do your part the very best that you possibly can. This will inspire others to do the same.
- Show appreciation to people for what they contribute.
- Encourage people to do their best.
- Make people needed. Working together is a lot more fun that way.
- Don't isolate or exclude anyone. Everybody has something valuable to offer, and nobody likes being left out.

## UNIT 8.6: Group Interaction

### Unit Objectives

**At the end of this unit, participants will be able to:**

1. Participate in group discussions in the class.
2. Give speech in the public.
3. Paraphrase the importance of team building and team work.

### 8.6.1 Group Interaction

Every day we meet with groups of people socially and professionally. How we interact plays a large role in the impressions we create. Interaction that occurs while a group completes a cooperative task describes how the group works.

Everything you do in a group setting makes an impression on everyone in the group. Don't ever think something doesn't matter. Everything matters. Take every opportunity to take part in informal and formal group interactions. Start by making small contributions to discussion, prepare a question to ask or agree with another person's remark. Ask for other persons opinion.

#### Dos and Don'ts of Group Interaction

Do's	Don't
<ul style="list-style-type: none"> <li>• Speak pleasantly and politely to the group.</li> <li>• Respect the contribution of every speaker.</li> <li>• Remember that a discussion is not an argument. Learn to disagree politely.</li> <li>• Think about your contribution before you speak. How best can you answer the question/ contribute to the topic?</li> <li>• Try to stick to the discussion topic. Don't introduce irrelevant information.</li> <li>• Be aware of your body language when you are speaking.</li> <li>• Agree with and acknowledge what you find interesting.</li> </ul>	<ul style="list-style-type: none"> <li>• Lose your temper. A discussion is not an argument.</li> <li>• Shout. Use a moderate tone and medium pitch.</li> <li>• Use too many gestures when you speak. Gestures like finger pointing and table thumping can appear aggressive.</li> <li>• Dominate the discussion. Confident speakers should allow quieter students a chance to contribute.</li> <li>• Draw too much on personal experience or anecdote. Although some tutors encourage students to reflect on their own experience, remember not to generalize too much.</li> <li>• Interrupt. Wait for a speaker to finish what they are saying before you speak.</li> </ul>

Fig.8.6.1: Dos and Don'ts of Group Interaction

## 8.6.2 Teamwork

Teamwork is a very important part of working life. They can have a big impact on:

- The profitability of an organisation
- Whether people enjoy their work
- Staff retention rates
- Team and individual performance

### **Importance of Team Building**

Team building activities not only boost morale of the team members, but it can also increase the success rate of the teams. Team building is an important activity as it:

- Facilitates better communication
- Motivates employees
- Promotes creativity
- Develops problem-solving skills
- Breaks the barrier

## UNIT 8.7: Time Management

### Unit Objectives

At the end of this unit, participants will be able to:

1. Describe the concept of time management.
2. Develop time management skills.
3. Explain effective time planning.

### 8.7.1 Time Management

Time management is the act of process of planning and exercising conscious control over the amount of time spent on specific activities, especially to increase effectiveness, efficiency or productivity. It is an activity with the goal to maximize the overall benefit of a set of activities within the boundary condition of a limited amount of time.

#### Some effective time management

- Delegate tasks.
- Identify time wasters.
- Combine activities – Plan for them.
- Break down big tasks down to the smallest task possible.
- Accomplish them one by one.
- At the end of the day conduct a simple analysis to see which activity took time.

### 8.7.2 Pareto Analysis

- According to this 80% of the tasks can be completed in 20% of the time. The remaining 20 % of the tasks take 80 % of your time. And the task which should fall in first category should be given a higher priority.
- Time also depends on the method adopted to complete the task. There are always simpler and easier ways to complete the task. If one uses complex ways then it will be time consuming. One should always try to find out alternate ways to complete a task.

#### Urgent Important Matrix

1. The Urgent and Important Tasks	2. The Non Urgent but Important Tasks
DO NOW <ul style="list-style-type: none"> <li>• Emergencies, complaints and crisis issues</li> <li>• Demands from superiors</li> <li>• Planned tasks or project work now due</li> <li>• Meetings with superiors/colleagues</li> </ul>	PLAN TO DO THEM <ul style="list-style-type: none"> <li>• Planning, preparation</li> <li>• Scheduling</li> <li>• Designing, testing</li> <li>• Thinking, creating, modelling the data</li> </ul>

3. The Non Important but Urgent Tasks	4. The Non Important and non-Urgent Tasks
<p>REJECT AND EXPLAIN</p> <ul style="list-style-type: none"> <li>• Trivial requests from others</li> <li>• Apparent emergencies</li> <li>• Misunderstandings appearing in work</li> <li>• Pointless routines or activities</li> </ul>	<p>RESIST AND CEASE</p> <ul style="list-style-type: none"> <li>• Comfort' activities, computer</li> <li>• Games, net surfing, excessive</li> <li>• Cigarette breaks</li> <li>• Chat, gossip, social</li> <li>• Communications</li> <li>• Reading irrelevant and useless material</li> </ul>

Fig.8.7.1: Urgent Important Matrix

**This matrix helps you understand:**

- What should be done
- What should be planned
- What should be resisted
- What should be rejected

The simplest method of managing time is to create a general to do list. Prioritize the task list:

- A daily list of things to do, numbered in the order of their priority
- Start with the most unpleasant and difficult task first latter will completed easily and quickly.
- Map out everything while making a task list
- Learn to say “No” to unimportant things
- Strikeout the things completed so that you are familiar what have been completed and what needs to be completed.

Prioritize the above mentioned activities in the following heads.

Important Tasks	Unimportant Tasks	Urgent Tasks	Not Urgent Tasks

## UNIT 8.8: Resume Preparation

### Unit Objectives

**At the end of this unit, participants will be able to:**

1. Explain the importance of resume.
2. Discuss basic steps for the preparation of a resume.

### 8.8.1 Introduction

A resume is a self-advertisement that, when done properly shows how your skills, experience and achievements match the requirement of the job you want. The resume is a tool with one specific purpose to win an interview. It convinces the employer that you have what it takes to be a successful in the new career or position.

It also establishes you as a professional person with high standards and excellent writing skills based on the fact your resume is written well. It also helps you clarify your direction, qualifications and strengths, boost your confidence or to start the process of committing to a job or a career change.

**One must know about a resume that:**

- Your resume is to get you an interview not a job
- Your resume will be screened by an employer for just 15-20 seconds. That's all the time your resume has to make an impact.

There are different sections on the resume in the same order as mentioned under:

Section	What is the employer looking for
Header	Your identity and to contact you
Objective	To check if their requirement and your objective match
Education	To check if you have the basic qualification for the job/ internship you are applying for
Practical Experience/Projects	To see if you have done anything that reflects your potential capability. Also to see how different you are from your peers.
Skills	How equipped you are in terms of your personality traits as well as occupational skills
Interests	Professional aspects apart, how meaningful is your life?
Other	Is there anything else significant and relevant you want to showcase, that will add value to your resume.

*Fig.8.8.1: Different sections on the resume*



## 8.8.2 Points to Remember

- Make sure that the length of your resume does not exceed 2 pages.
- Do a thorough recheck and make sure there are absolutely no errors in your resume. No grammatical errors, no spelling mistakes, no punctuation errors.
- Run through your resume time and again for to make improvements and wording sentences better.
- Choose a professional font in a size 11 or 12. You can use multiple fonts for different parts of resume, but try to limit it maximum of two fonts. Instead changing between fonts, try making specific sections bold or italicized instead.
- The font size of your header and the introduction to a section may be a size 14 or 16.
- Your text should always be printed in solid black ink. Make sure to deactivate any hyperlinks so that they don't print in blue or other contrasting colour.
- Your page should have one inch margin all the way around with 1.5 or 2 point line spacing. The body of your resume should align left and your header should be centred at the top of the page.

## UNIT 8.9: Interview Preparation

### Unit Objectives

At the end of this unit, participants will be able to:

1. Explain the procedure of an interview.
2. Prepare for interview.

### 8.9.1 Interview

An interview is a conversation between two or more people (the interviewer(s) and the interviewee) where questions are asked by the interviewer to obtain information from the interviewee. An interview is the first and last hurdle you need to cross in order to get a job.

#### Common Types of Interview

1. **Traditional HR Interview:** Most interviews are face to face. The most traditional is a one-on-one conversation with the HR Executive where the candidate's focus should be on the person asking question. You are advised to maintain good eye contact, listen keenly and answer promptly.
2. **Panel Interview:** In this situation, there is more than one interviewer. A panel ranging from two to ten members may conduct this part of the selection process. This is an ideal chance for you to display group management and group presentation skills.
3. **Technical interview:** The objective of this interview is to basically evaluate technical knowledge. Majority of the questions will be based on the skills sets mentioned in the candidate's resume.
4. **Telephone Interview:** Telephone interviews may also be used as a preliminary interview for candidates who live far away from the job site.

Before going for an interview, it is important to have clarity of the role you are applying for. It's also important that you know where you are applying and who will you be talking to. Your answers should tell the employer that you are the match they are looking for.

This requires you to do a small research on the following fields:

- Company & Field
- Job Description
- Yourself (Skills, Values & Interests)
- Resume (Experience)

It is important that you dress professionally. It is a proven fact that the way we dress makes a huge difference in the way we are perceived. 90% of the way you communicate with other people is through body language (gestures, expressions, etc.) and the first Impression we make. It is very simple to make a great first impression.

For a good first impression it is important those we:

- Smell good
- Have a professional appearance

- Pay attention to your grooming
- Make eye contact
- Know what and how you speak
- Our overall personality contributes to our complete perception.

#### How to dress for Interview

Men	Women
Long-sleeved buttoned shirt (clean and pressed)	Conservative pump, no stilettos
Dark shoes (cleaned and polished) and dark socks	Jewellery -One set of earrings (preferably knobs)
Get a haircut (short hair is always best)	No bangles
No Jewellery (chains, earrings, piercing)	Minimal use of makeup
No beards or Tattoos	

Fig.8.9.1: Dress for Interview

### 8.9.2 The Do's and Don'ts in an Interview

Some of you might have faced an interview and some of you might not have. However, by now, you definitely have a better understanding what are the accepted standards of a professional behaviour. Read the sentences given and mark them as do's or don'ts, in relation to an interview:

Sentence	Do's	Don'ts
Be yourself		
Burp while talking!!!		
Just out from a 'powder factory' ( worn too much make-up)		
Reach just about the right time for the interview		
Just barge in the cabin/ office		
Forget to greet the receptionist/ don't respond		
Think before you speak		
Do your homework- Visit the company website		
Take time to think (TTTT)		
Wear bright colour clothes on the D-day		
Emphasis on your strengths		
Argue/ Debate with the interviewer		
Chew gum during the interview.		
Review your educational and work experiences		
See your documents flying out of the file (Being clumsy)		
Thank the interviewer		
Have the 'they need me' attitude		

Maintain eye contact and good body language		
Only give monosyllabic answers(depends on the kind of questions asked... in-between)		
Carry a copy of your resume		

*Fig.8.9.2: Do's and Don'ts in an Interview*

### 8.9.3 During the Interview

- Be confident, not arrogant
- Sell yourself - Keep your energy up
- Maintain your posture
- Be positive, don't complain
- Know your resume and accomplishments.

It isn't sufficient to have ideas. They have to be expressed effectively in the interview. The parameters that the candidates are assessed on during the interview are very simple. These are the parameters that this training program has prepared you for.





## 9. Annexure-Resources



Module No.	Unit No.	Name of Subject	URL	QR Code
1. Introduction and Orientation	Unit 1.1 - Apparel Industry	Apparel industry in India	<a href="https://youtu.be/tN5oLGSjepQ">https://youtu.be/tN5oLGSjepQ</a>	
1. Introduction and Orientation	Unit 1.2 - Role and Responsibilities of Self Employed Tailor	Role and Responsibilities of Self Employed Tailor	<a href="https://youtu.be/YdMoYiBDCIM">https://youtu.be/YdMoYiBDCIM</a>	
2. Drafting and cutting the fabric	Unit 2.1 - Tools and Equipment Required for Tailoring	Tools and equipment used in sewing	<a href="https://youtu.be/_2ZLtGfBJrY">https://youtu.be/_2ZLtGfBJrY</a>	
2. Drafting and cutting the fabric	Unit 2.5 - Taking Measurements	Garments measurement system	<a href="https://youtu.be/Ki8T_KEg81Q">https://youtu.be/Ki8T_KEg81Q</a>	
2. Drafting and cutting the fabric	Unit 2.6 - Drafting and Cutting	Bodice Pattern With Darts	<a href="https://youtu.be/xR-59vVNaxU">https://youtu.be/xR-59vVNaxU</a>	
2. Drafting and cutting the fabric	Unit 2.7 - Types of Fabric Defects	Categorization of garment defects	<a href="https://youtu.be/SPtD6mAZ0GU">https://youtu.be/SPtD6mAZ0GU</a>	
3. The Sewing Process	Unit 3.1 - The Sewing Process	Types of sewing machines	<a href="https://youtu.be/_2ZLtGfBJrY">https://youtu.be/_2ZLtGfBJrY</a>	

3. The Sewing Process	Unit 3.2 - Stitching	Parts of a sewing machine	<a href="https://youtu.be/al_hc7DoKXk">https://youtu.be/al_hc7DoKXk</a>	
3. The Sewing Process	Unit 3.2 - Stitching	Types of stitching	<a href="https://youtu.be/NtmiZU1dkZM">https://youtu.be/NtmiZU1dkZM</a>	
3. The Sewing Process	Unit 3.2 - Stitching	Sewing a pant	<a href="https://youtu.be/Q3Y5Q_iW1Ao">https://youtu.be/Q3Y5Q_iW1Ao</a>	
3. The Sewing Process	Unit 3.2 - Stitching	Attaching belt in a pant	<a href="https://youtu.be/7Biev39gR2k">https://youtu.be/7Biev39gR2k</a>	
3. The Sewing Process	Unit 3.2 - Stitching	Sewing a shirt	<a href="https://youtu.be/g7AA-gfAKes">https://youtu.be/g7AA-gfAKes</a>	
4. Inspections and Alterations for Fittings	Unit 4.1 - Inspections and Alterations for Fittings	How to ALTER	<a href="https://youtu.be/wGn1H5dCMkQ">https://youtu.be/wGn1H5dCMkQ</a>	
5. Maintain Work-Area, Tools and Machines	Unit 5.1 - Maintain Work Area, Tools and Machines	Maintenance of single needle sewing machine	<a href="https://youtu.be/6iE2DT6LVpg">https://youtu.be/6iE2DT6LVpg</a>	



6. Maintain Health, Safety and Security in Tailoring Shop with Gender & PwD Sensitization	Unit 6.1 - Maintain Health, Safety and Security in Tailoring Shop	Health related threats in apparel industry and control on them	<a href="https://youtu.be/POIQ27GQZp0">https://youtu.be/POIQ27GQZp0</a>	
6. Maintain Health, Safety and Security in Tailoring Shop with Gender & PwD Sensitization	Unit 6.2 - First Aid and CPR	First aid	<a href="https://youtu.be/DQ7JPNgU8Wg">https://youtu.be/DQ7JPNgU8Wg</a>	
6. Maintain Health, Safety and Security in Tailoring Shop with Gender & PwD Sensitization	Unit 6.3 - Sensitivity towards People with Disability and Gender Equality	Gender sensitization	<a href="https://youtu.be/Wi1exdO1lig">https://youtu.be/Wi1exdO1lig</a>	



<https://youtu.be/YdMoYiBDCIM>  
Scan QR code to access e-book



### Skill Council for Persons with Disability

Sector Skill Council Contact Details:

**Address:** 501, City Centre, Plot No. 5 Sector 12 Dwarka New Delhi - 110075

**Website:** [www.scpwd.in](http://www.scpwd.in)

**Phone:** 01120892791

Price: ₹